

Nuquitedi anquiadnuna

Seta icquid

5



Matsses

Cuaderno de trabajo de inicial 5 años



PERÚ

Ministerio de Educación

La ciudadana y el ciudadano que queremos



Nuquitedi anquiadnuna

Seta icquid

5





Ministerio de Educación

Dirección General de Educación Básica Alternativa, Intercultural Bilingüe
y de Servicios Educativos en el Ámbito Rural

Dirección de Educación Intercultural Bilingüe

Nuquitedi anquiadnuna 5

Cuaderno de trabajo y folder - Inicial 5 años - Matsés

©Ministerio de Educación

Av. De la Arqueología cuadra 2, San Borja

Lima, Perú

Teléfono: 615-5800

www.gob.pe/minedu

Primera edición, 2020

Tiraje: 121 ejemplares

Impreso en Noviembre 2020

Elaboración de contenido

Anicia Tupa Jiménez Huanán

Revisión de contenido

Anicia Tupa Jiménez Huanán

Revisión lingüística

Fidel Inuma Pemi

Validación participativa

Reyna Ahuanari Clara, Mercid Beso Shabac Duni

Asesoría y revisión técnica Digeibira-DEIB

Bertha Liliana Pacheco Díaz

Ilustraciones

Jean Pool Bejarano Herquínigo

Archivo Digeibira-DEIB

Diseño y diagramación

Cynthia Carolina Guivobich Vargas, César Adolfo Yeckle Castro

Cuidado de la edición

Marlene Sofia Silva Huerta

Impreso en CECOSAMI S.A.

Cal. 3 Mza. E Lote 11 Urb. Santa Raquel - Lima - Ate

RUC: 20469820531

Hecho el Depósito Legal en la Biblioteca Nacional del Perú

N° 2020-05848

Todos los derechos reservados. Prohibida la reproducción
de este libro por cualquier medio, total o parcialmente, sin
permiso expreso de los editores.

Impreso en el Perú/*Printed in Peru*



Bedanquin tantiamiaid

Umbi tantiaido champibobëdi dadampibo dadauaquido:

Nëid dadauate isbante mibi chedona nec. Bëdambo dayacquo icquin nabanombi, chonuadquin. Mibi ismequido tedi tsidadash tabadquin nabanombi. Ma mibi chedo bëdambuec anquiadec mamënnu qeshun. Nëid dadauaten bëdambo mibi anquiadtiadquo icquido iquec. Mimbentsëqui nabanec, mibëtan dadauaquidbëtan nabanec, min shubun icquidobëtan nabanec. Nëid dadauaten bëcadobanquin isbanec mibi anquiadec. Mibi yacnoshon nabanaid, tsidadash tabadquin nabanaid, ënden icaidbëta tantiaquin nëbi icquid isbanec, nimëduc icquidobëd bëdambo icaid chedo. Adecbidi utsibo yacnoshon nabanaidtsen isbanec. Nëid dadauaten dadpenquioshë anquiadquin mimbi istuidec. Ënden icnëdaid bëdaidquo nec quequin tantiabanquimbi, nëbi icaid isbanec, cun onquetembi onquequid nebi quequin tantiec. Bëca abentsëquën mimbi natequid icnidec: mibi mamëntequid, mapin tantiatequid, daëd bedshun isbantequid, naquin istuidbante, sauan dadauate, annoshcabante, dënaimbante. Aden nabanquin chuinanec bëdambuec mibi anquiadec.

Aden nabanquin min dadauate shubu bëdambocquid mimbi icmec. Mibi matses bëdambuen tantiaquid icmete. Nëid dadauate bëdambuen dayunuaquin istac mibi caimbi. Ma mibi aidën icquid anquiacnuc, mibëd icquidbimbuec iuecquo icquin.

Dirección General de Educación Básica Alternativa Intercultural Bilingüe y de Servicios Educativos en el Ámbito Rural (DIGEIBIRA)

**Min sauani
dadauashun min
cuëmëdaid dadaua.**



Cun cuëmëdaid

Bacuëbo ismequid chido chiaid:

Bacuëbobëtan dadauate bëcadoquin isbanquin chui, midacquid abi bunaid iqueque.

Chui:

- ¿Midapaden nuqui aidën dadauate nec quequin tantiape?
- ¿Atoda natiad nëid cun dadauate nec quequin tantianun?

Bacuëbo nashun ambi dadauatequid nëid tëshquin “Cun cuëmëdaid”.

Bacuëbo chui ma ambi aton “sauambëta aton cuëmëdaid” dadauate istuidnu.



Istanquin dadaua:





Nuquin shubu nanuna

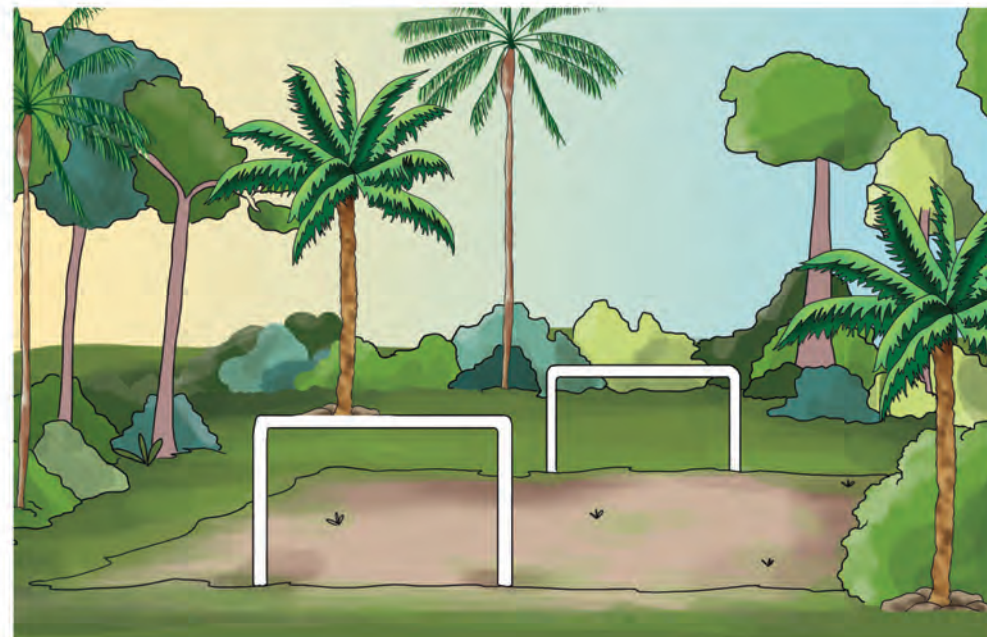

Min cuëmëdaid:.....

¿Midapaden shubu napec ubi iccuededacnoshon?

Bacuëbo ismequid chido chiaid:

Bacuëmpibo chuiban:

- ¿Midapaden shubu napec?
- ¿Ada iso? ¿Tsundan aton shubu naush?
- ¿Tsudabëtan aton shubu naush?
- ¿Atoda bedpec shubu nanun?
- ¿Tsundan shubuuquin ismepanëdash?

Bacuëmpibon chuibansho tantiashun dadauaban.

Umanuc shubu tabadacno isbennec nidshun naden chui:

- ¿Atoda naid shubu nec?
- ¿Tsundan aton shubu naic?
- ¿Midapaden shubu nabanac?
- ¿Midapad shubu tabadec?
- ¿Tedtsi nuqui yacno shubu icpec?
- ¿Mitsipad shubu icpec utsi yacno?

Dadauate shubu yacno aucbi choshon isbennec capuquin shubu isbambued chuiban.

Bacuëmpibo dadauatebëta chicshun bitaccatsëcte mene bëca.

Tsiuec bëca icquidën sauan nibën A1.

Shubu dadauaid sauan icquid isquin chuiban. Aden isbanquin nëmbo cun shubu ictsiash quequin mëdban. Mibi yacnocquid shubumpi istanquin, dadauate cachoc icquid tëshshun bitaccaban. Nëmbo cun shubu ictsiash quequin mimbi isbocno.



Istanquin dadaua:

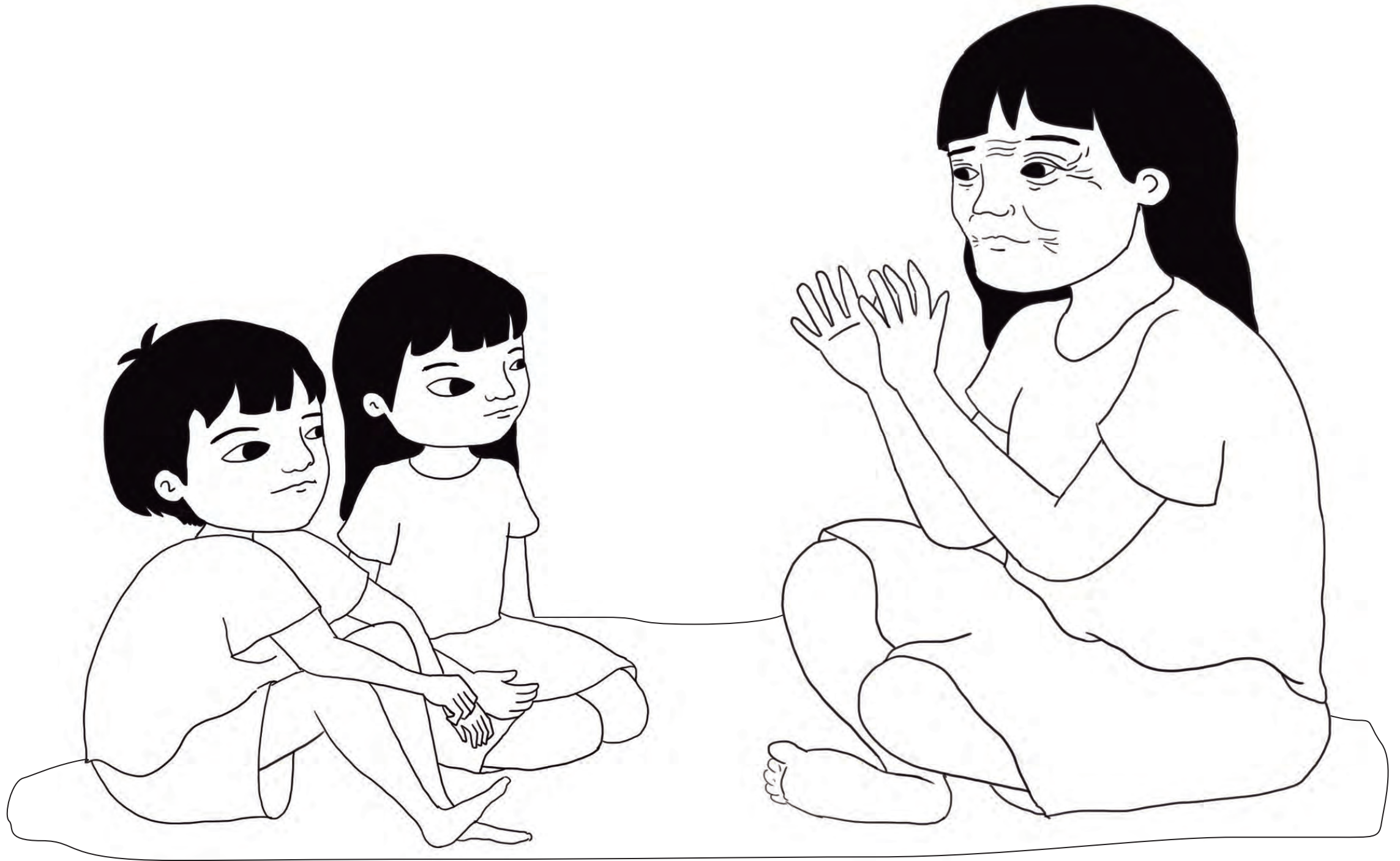

Min cuëmëdaid:.....

Nuquin buchidon nuqui mëquiaquec

Bacuëbo ismequid chido chiaid:

Bacuëmpibobëd shubu nacno nidshun istan.
Shubu icbon shubu nate tedi ismebanquimbi,
naden nëidën shubu naquid quequin
chuibanec.

Dadauate shubu yacnouësh bacuëmpibobëd
onquequin tantiabanec. Nuquin buchidon
chiaid natequidquo nec bédambuen shubu
nanun quequin.

Ambi dadauabantequid dadauate mene.

**Sauan isquin chuiban atoda matsesën naique. ¿Tsundan matses namepec?
Buchidon sauan annoshca.**



Istanquin dadaua:

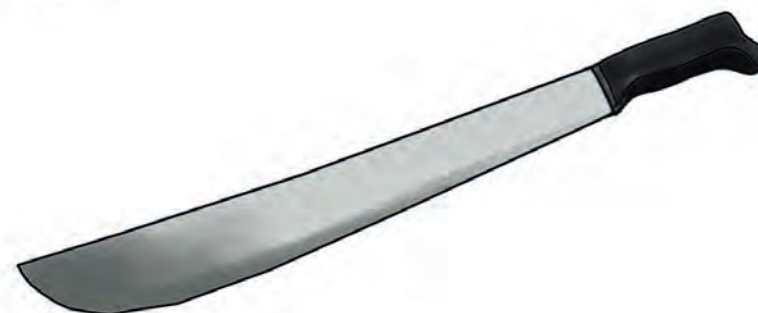

Min cuëmëdaid:.....

¿Atondan shubuuaquin nabantiad?

Bacuëbo ismequid chido chiaid:

Dadauate shubu yacnoshon bacuëmpibo chui, shubu naquin sanante tedi chuiban quequin.

Adoshon tanme mitsitsipadec papa, buchi, mibi yacnocquido aidën chonuadpec quequin.

Dadauate meneban ma shubu naic chonuadtequid ambi chuibanaidën sauan abibimbuecnuc dadauanu. Aden nashun ambi naid tsitsanën sanduec. Adtanec umanuc puduenec.

Adoshon umanuc buan mamënteyacno.

Adotanquimbic tsitsan tsadunme nëntanquio mamënteyacno.

Bacuëmpibon 4 ted seta icquidon bedec, tsitsanën ambi sandobued nibënquin.

Adshun isec abëd icquidobëtan tsundan umbi bedaidquiobidi bedosh quequin.

Abiuidquio bedquidtedishun chiec, naded nëidën chonuadec quequin.

Bacuëmpibo 5 ted seta icquidon sauan dadauaid bedbanec. Aden bedtanec aidbidi bedquiduidquio tsidadshun nidaidën sanec. Aden sanshun isbanquin ambi bedaidën cuëmëdaid chuibanec.

Ambi nabantequid dadauate meneban, dadauate cachoc ënëdacno sauanëmpi icquidbëta.

Midacquidën bëchun shui matueque abimbo yacno semequin sin. Adoshombic midacquidën ayash tësnnun tepec.



Istanquin dadaua:

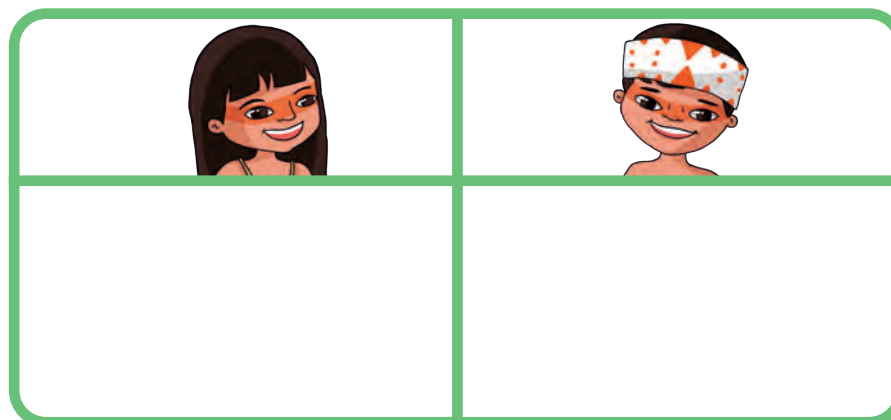

Min cuëmëdaid:.....

Nuquin shubu naic abitedi tsidadshun

Bacuëbo ismequid chido chiaid:

Bacuëmpibo isme damina caidën shubu naquidën sauan dadauaid.

Adoshon naden chuiban:

- ¿Teda matses sauan dadauaidën iquec?
- ¿Atotsi nabededec?
- ¿Midapadec chonuadcuededec?
- ¿Atotsi quepatsiash aton matsesadon shubuaquin nuqui nashunac?

Bacuëmpibon papa abentsëc chome, ma bacuëmpibobëta champichedo tsidadash chonudac bëdambo icaid tedi chuiquin tantiamenu.

Matsesën tsidadshun naidtedi chuiban: shubuaic, tieduaic, chetequid icsho bedec, nuëcquid dectatoquid bedec.

Bacuëmpibo chuiban:

- ¿Atotsi napec aton shubu yacno nashunun?
- ¿Atotsi napec dadauate shubu yacno nashunnun?

Tsiuec bëca icquidën sauan nibën A1.

Matses tsidadash chonudquid issun bitacca. Adoshon dadampibëta chidompi tanquin cuestempin tancaquin tamban.



Istanquin dadaua:

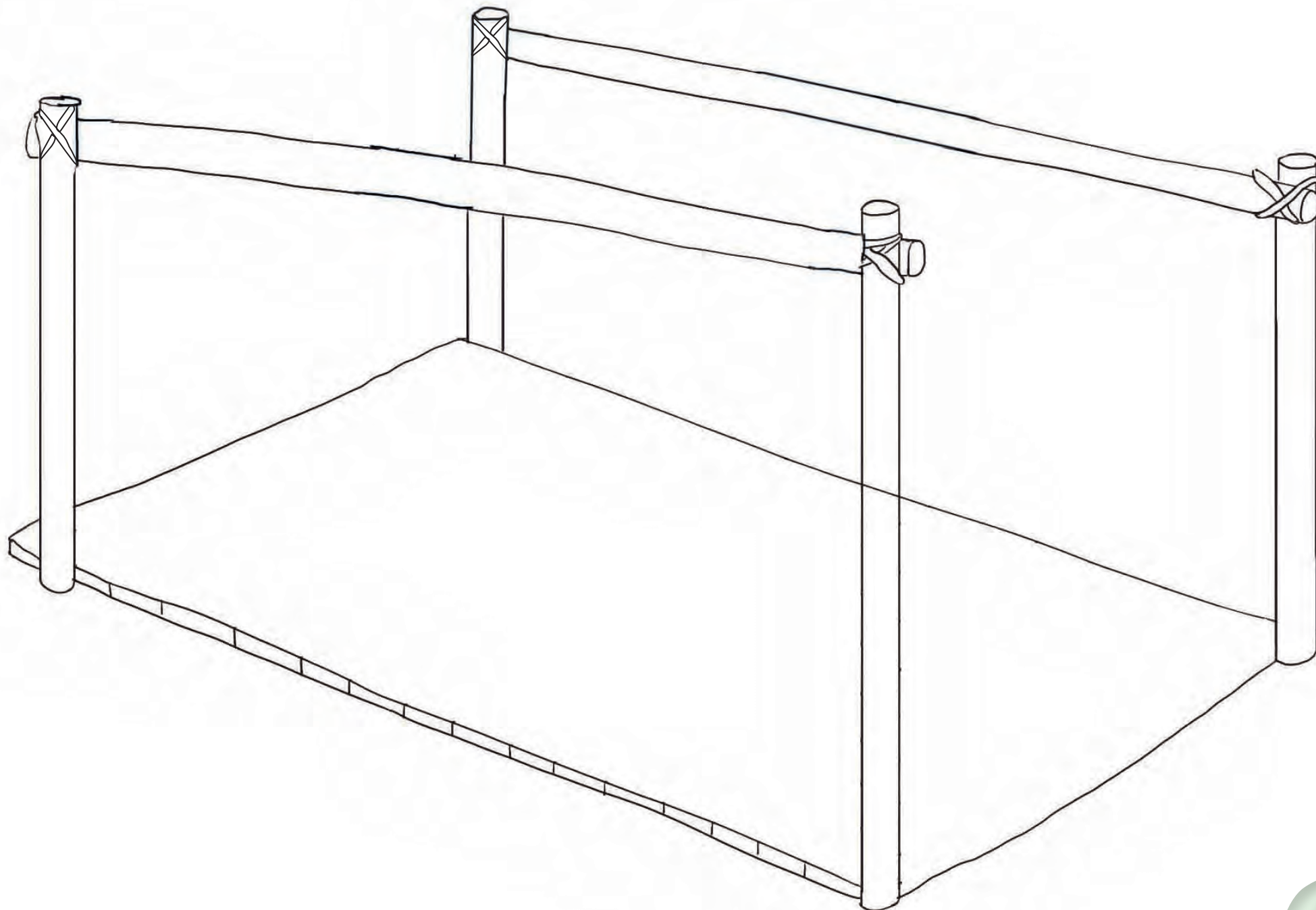
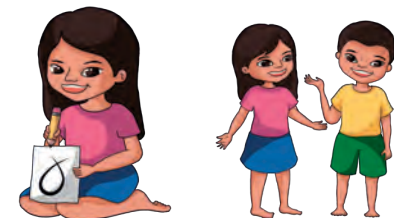

Min cuëmëdaid:.....

Shubuuaquin bedannuna

Bacuëbo ismequid chido chiaid:

Shubu nacno nidash mibi chedo anquiadcuededbued ada tantiabedede.

- ¿Midapadquid cuate nec shubuuatequid?
- ¿Midacquidquio buintad nitsimpec?
- ¿Midacquid cuituadte nec?

Bacuëbo 4 ted seta icquido cuestempi nuapambo icquidbëta aniactsëquidëmpi meneban.

Abitedi cuestempi tembimbo icquiduidquio bëdambo iquec.

Cuestempi tembimbo icquiduidquio tsinac quequin chui.

Bacuëbo 5 ted seta icquido cuestempi nuapambo icquidbëta aniactsëquidëmpi meneban utsi-utsiecquid.

Cuestempi tembimbo icquiduidquio tsinac quequin chui.

Ambi nabantequid dadauate meneban, dadauate cachoc ënëdacno sauanëmpi icquidbëta.

Shubu shictodouaid min dupisën nainquin dadauaban.



Istanquin dadaua:

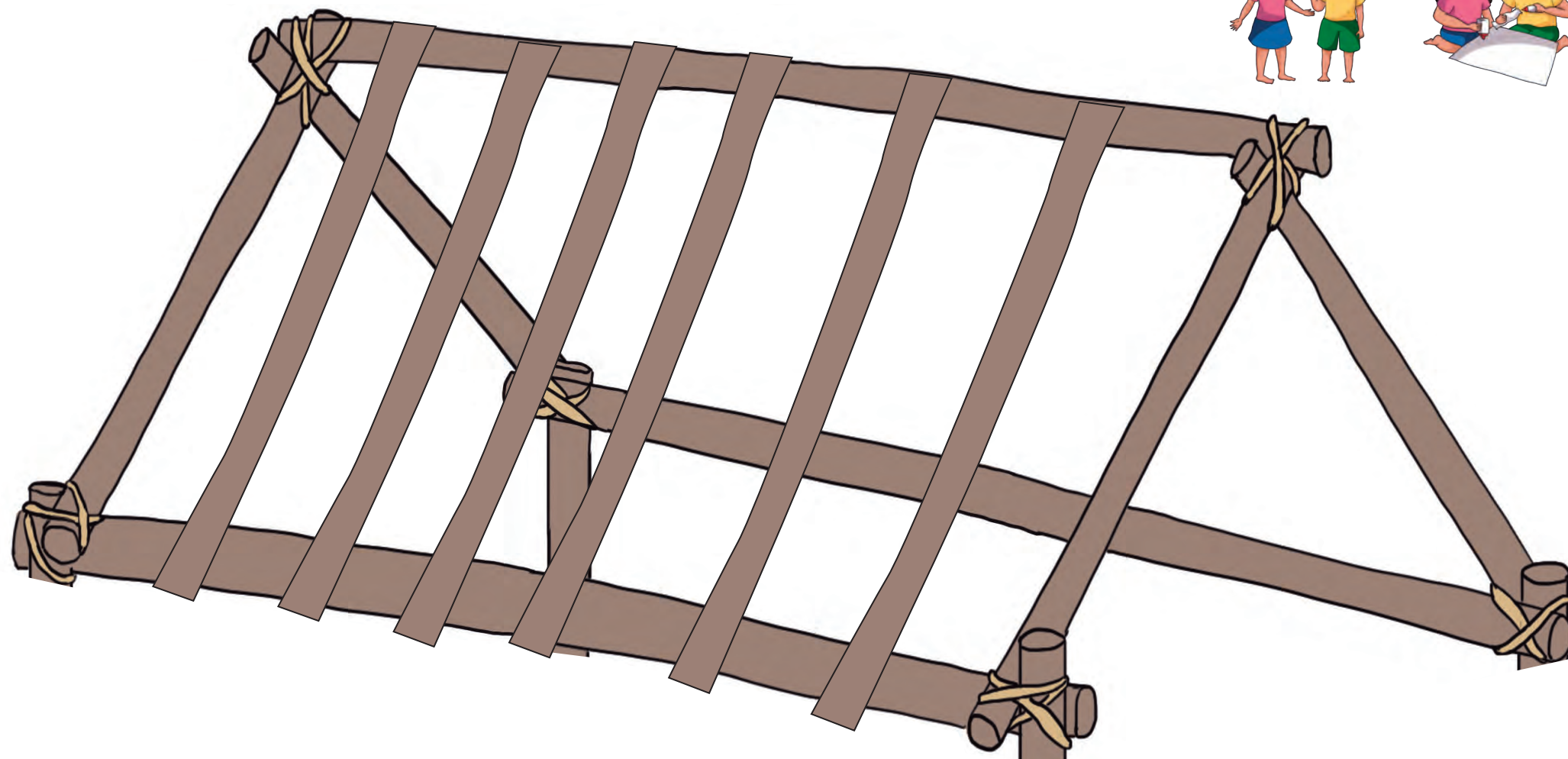

Min cuëmëdaid:.....

¿Atotsi nabedec dadabëtan chidon shubu nëshnun?

Bacuëbo ismequid chido chiaid:

Bacuëmpibo chui mitsipaden chidobon nashumpec, shubuuacno.

Adembidi dadabontsen mitsipaden nashunuapec quequin. Bacuëmpibobëd nidshun aton buchidobëta aton chichi isme ma budëd daëdcaquin ismenu.

Daduate shubu yacno chouash tiquidiuash tabadquin champichedon chiec, bacuëmpibo.

Mitsipaden chiosh nuquin buchidon budëd daëdcate quequin.

Adec onquetanquin bacuëbo ismequid chidon papedoten shubu nëshnun nainquin shictodouaquin sauan dadauaid dectanec. Aden dectanacsho bacuëbon ambi shubumpi daëdcaid bëbued nështoquin tanec. Ambi aton papa chedon nasho isboc padombuen.

Tsiuec bëca icquidën sauan nibën T1.

Tështanquin shubu podompi daëdcacimbuen natanquin, shubu shictodouaid icacno bitacca.



Istanquin dadaua:



Min cuëmëdaid:.....

¿Mitsipad matsesën shubu icpec?

Bacuëbo ismequid chido chiaid:

Bacuëmpibo champichedobëta chui shubu tabadacno isec nidnun. Adshun isme shubu icquidtedi.

Nadentsembidi chiac bëdambo iquec:

- ¿Mitsipad shubu iquec?
- ¿Atotsi nëshaid nec?
- ¿Midapad quënëüaid isadec?
- ¿Tedtsi iste shëcuë iquec?
- ¿Abitedimboda abibiuidquio isadec?

Aden istanec chouashun paped meneban, ma shubun sauan abentsëc dadauanu ambi isbued.

Aden nainquin shubun sauan natanquin mibëtan dadauaquido chui quequin chui midapad ambi shubun sauan dadauaid iqueque.

Dectan nidaidën sauan dadauabued.

Bacuëmpibo 4 ted seta icquid chui:

- ¿Abitedimboda abiuidquio isadec?

Abiuidquio isadquiduidquio dectamban quequin chui.

Bacuëmpibo 5 ted seta icquid chui:

- ¿Abitedimboda abiuidquio isadosh?
- ¿Midacquid shubu padpidaëdquio tsaduntiad icpec?

Ambi nabante dadauatebëta matasante meneban.

Tsiuec bëca icquidën sauan nibën A2.

Sauanëmpi tasbantandin abimbuec isadquiduidquio bitaccaban. Adoshon mibëtan dadauaquid chuiban, midapaden tantiaquin mimbi tsinacquin bitaccaque.



Istanquin dadaua:



Min cuëmëdaid:.....

Mamënuna tsavesbëta bëdi tanec

Bacuëbo ismequid chido chiaid:

Umanuc puduenash bacuëbobëd
mamëncueded, tsaves aton shubun
puduedaid tanec.

Bacuëmpibobëtan 4 o 5 ted
shëcuëbimbuecnuc tiquidiua.

Bacuëmpi abentsëc bëdi caid nec, bacuëmpi
utsibobic tsaves caid nec, nimëduc capuquid.

Utsitsen nëish bëdin piaid tanec
mamëncueded.

Padpidec mamënquin bedan utsi-utsien nëish
ëctanec, bëdin piaidtedi.

Tsiuec bëca icquidën sauan nibën A2.

**Min sauambëta bëdin sauan dadaua, mamënuimbi. Adoshon mibëtan dadauaquid chui,
midambo bëdi iquec, midambo mibi iquec.**



Istanquin dadaua:

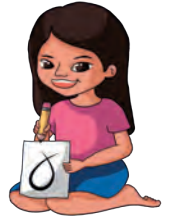

Min cuëmëdaid:.....

Anquiadacsho iste

Bacuëbo ismequid chido chiaid:

Tiquidiuaquin bacuëbo tabëc. Adec tabadquin dadauamequidën chuibanec bacuëbo abi anquiadaid. Ma bëdamboen tantianu qeshun bacuëbo ismequidën naden chuibanec:

- ¿Midacquidtedi nuqui isedpo?
- ¿Tsuda chedo nuqui isedpo? ¿Adembidi tsuda chedon nuqui isedposh?
- ¿Atoda nuqui ismeposh?
- ¿Atoda nuqui tantiacmaid anquiadpo?

Aden tantiaquin bacuëmpibo ismequidën menebanec. Bacuëmpibon ambi nabante utsi-utsien ma sauan nanu qeshun. Adembidi ma annoshcanu qeshun. Adecbidi abi ushë abentsëquën anquiadaid tantiec ma utsi-utsien chiec onquenu qeshun.



Istanquin dadaua:





**¿Atotsi mëdanten nabanaid
icpec?**

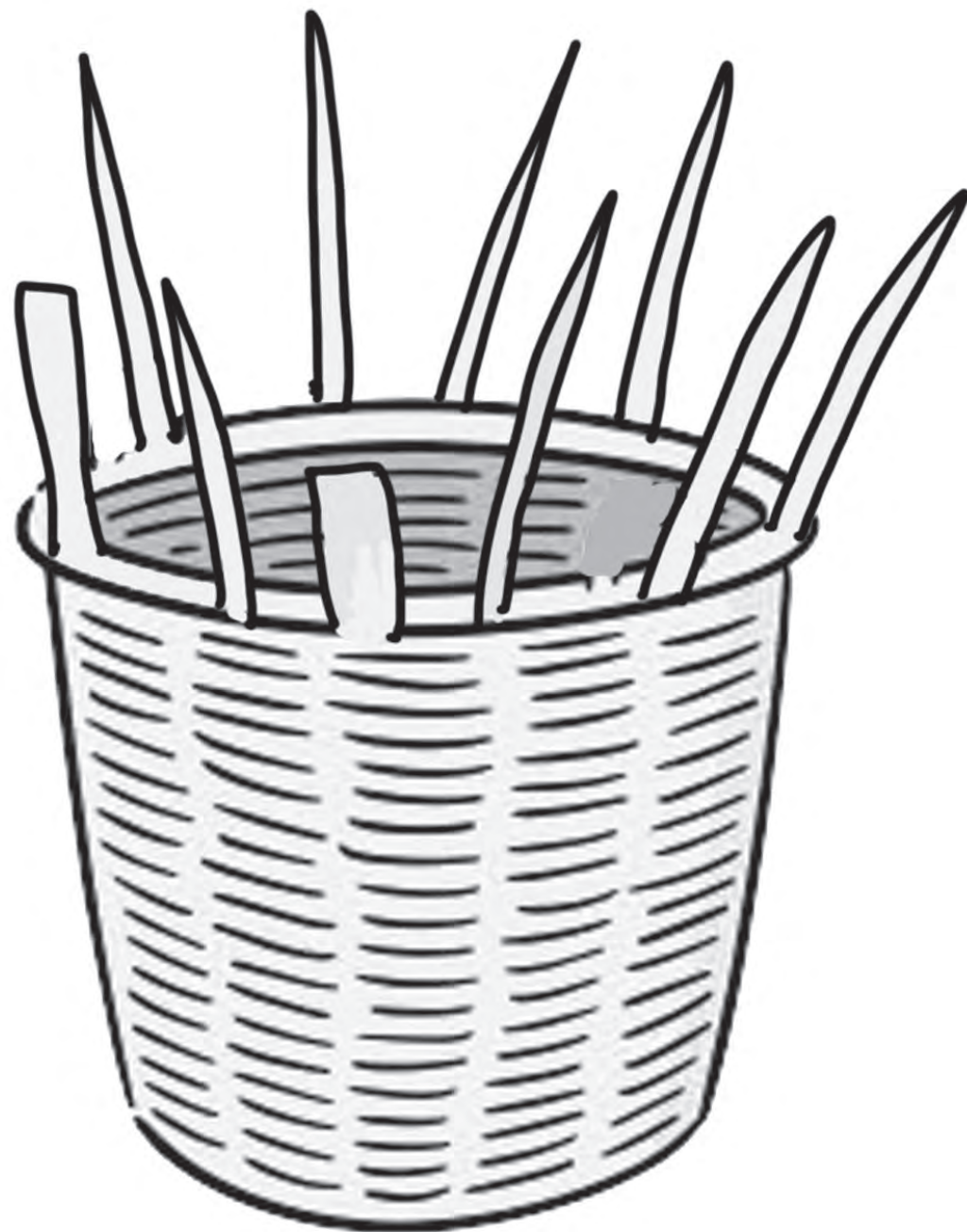
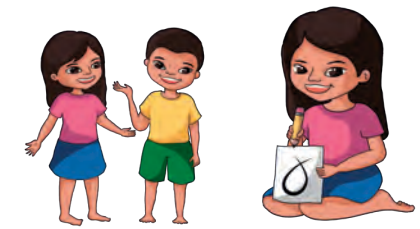

Min cuëmëdaid:

¿Tsuntsin daëdcaquin ismebempanëdash?

Bacuëbo ismequid chido chiaid:

Min bacuëbo nëid ënden chuinëdaid tantiame:

Ënden matsesën nëish cuesquid
tsibampanëdash.

Adec tsibanec nidquimbi tsitsanëmpi bëdambo
ictsëcnuç daëdcaidën aton machi buansho
ispanëdash.

Ashunquio aid bedshun isquin daëdcaquin
tanec mëquiadpanëdash.

Aden chic-chicquin isequi
mëquiadcuededpanëdash tsitsan daëdcaic.

Bacuëmpibo chui:

- ¿Tsuda matsesën tsibampanëdash?
- ¿Atoda tantiante bunquiopanëdash
matses?

- ¿Atondan buampanëdash aton pete?
- ¿Atoda capanëdash tsitsan?
- ¿Atoda tantiabempanëdash?

- ¿Midacquid min matsesën daëdcaquin
tantiapec?
- ¿Midacquid mibi daëdcate bunquiaid
nepec?

Tsitsan nainquin daëdcashun. Adoshon tsitsan daëdcaquidën cuëmëdaid tsadun.



Istanquin dadaua:

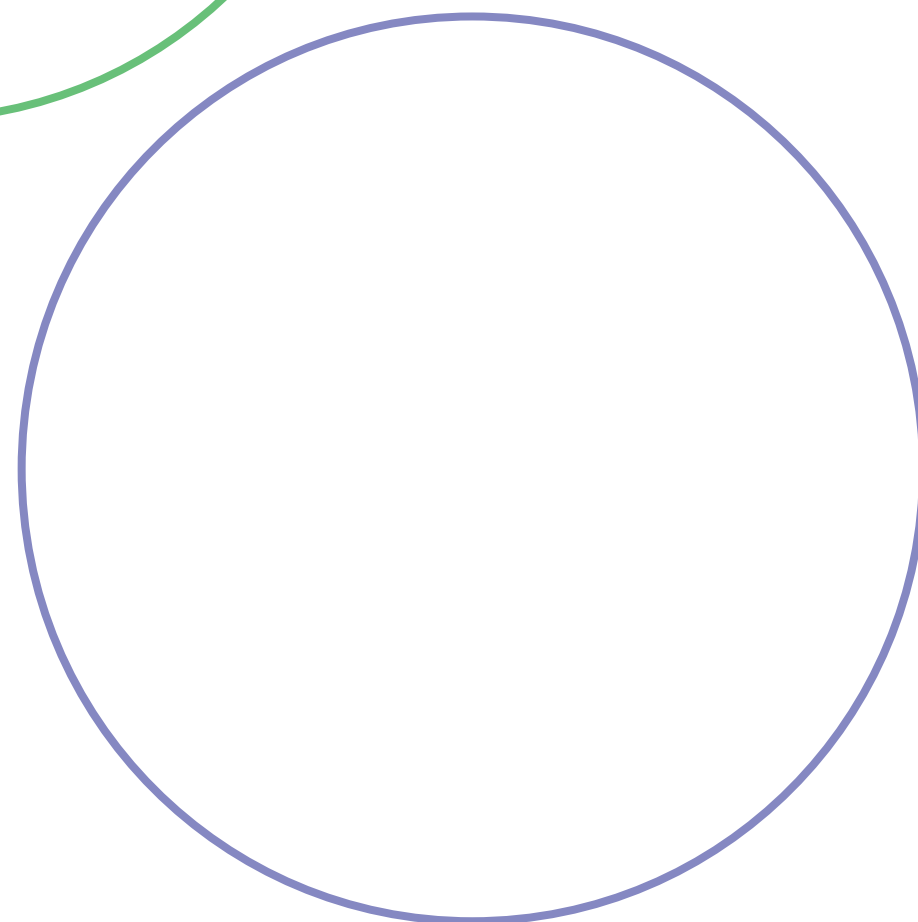
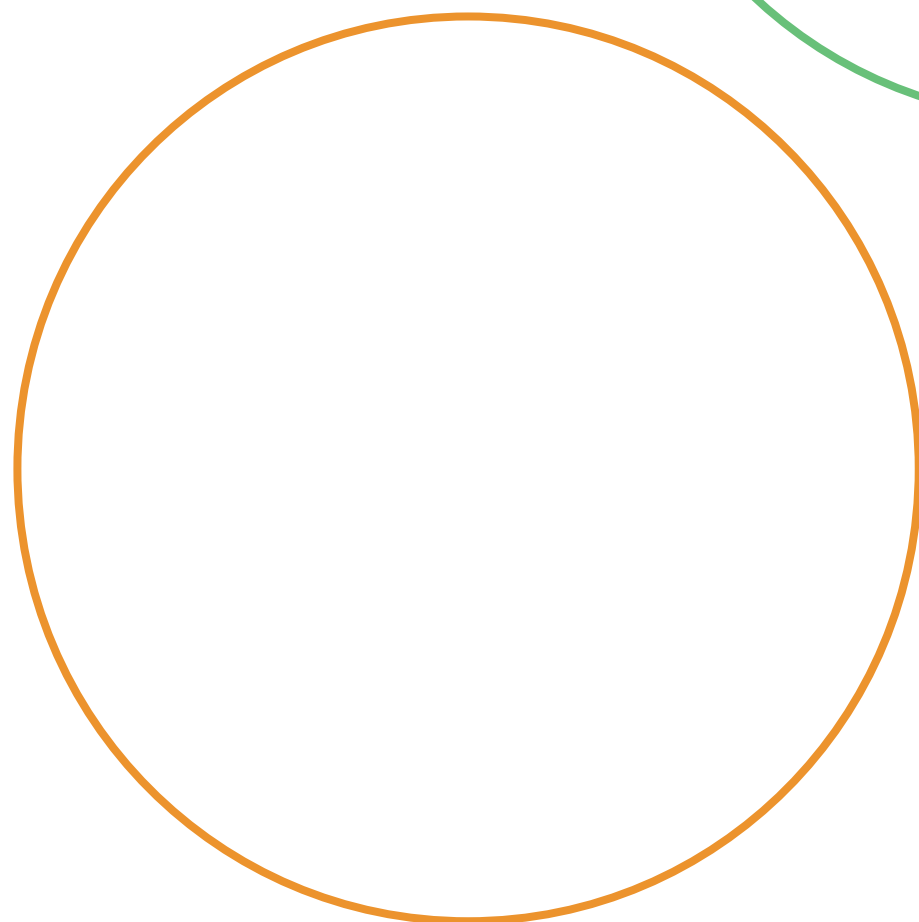
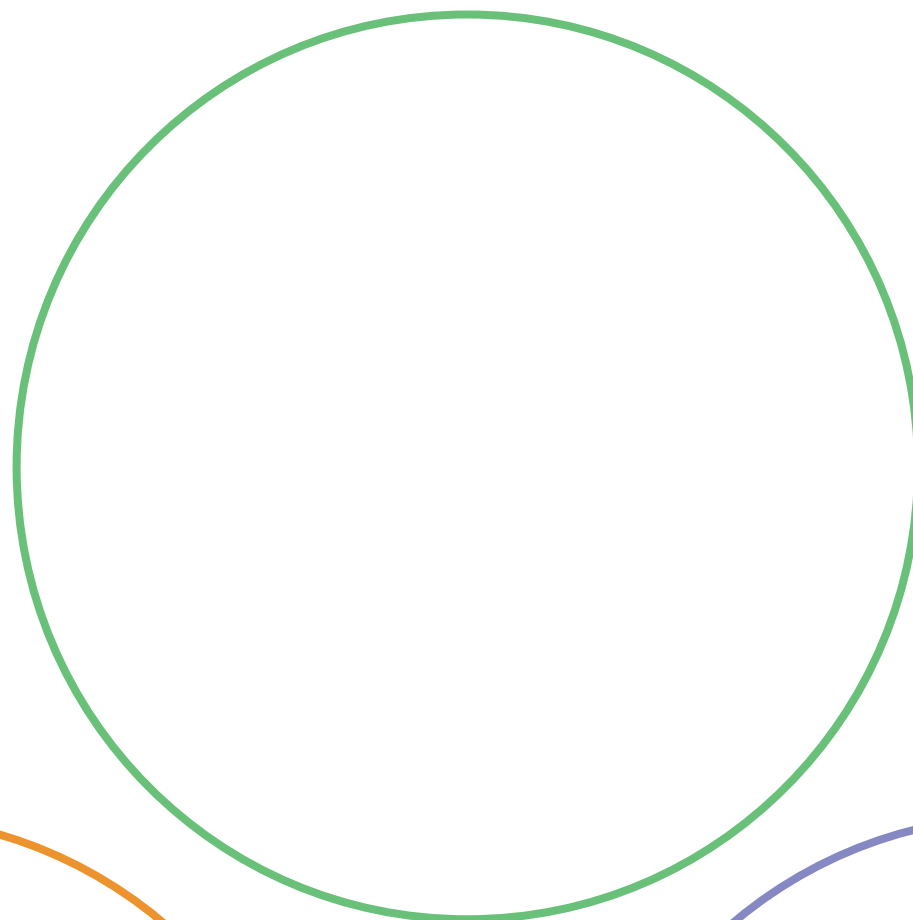

Min cuëmëdaid:.....

Midambo nuqui bedpe di daëdcanun

Bacuëbo ismequid chido chiaid:

Midambo utsi-utsien daëdcaquin tantiaquid iqueque nidshun aidën daëcaid isbededtan.

Ambo nidshun daëcaquid icbo chiec ada bacuëbon mishac bëdambo icpatsiash quequin. Aton matsesën chiec utsi-utsien ambi daëdcabudniaid isquin aid daëdcaid nec quequin. Dadauate shubu yacno choshon di bidi cashun daëdcaiduidquio isme, sedunte nacnenaid, dëshote tsasicquid, nëshaid daëdacaid, chiun chedo.

Adoshon naden chui:

- ¿Midacquid nimëduc bedshun naid nepec?
- ¿Midapaden naic quequin tantie?

¿Ada di dachinshun daëdcaid min shubu yacno iquec?

Adoshon bacuëbo naden chui:

- ¿Atoda mimbi daëdcaid min shubu nuntan iquec?
- ¿Tsundan aid di dachinosh?
- ¿Tsundan aid nate di dachinosh?
- ¿Midambo aid nabante di bidicate bedosh?

Tsiuec bëca icquidën sauan nibën A2.

Adoshombic abiuidquio tsinac tiquidiuashun, tsasimbocquiduidquio daëdcaiduidquio, posadquiduidquio.



Istanquin dadaua:

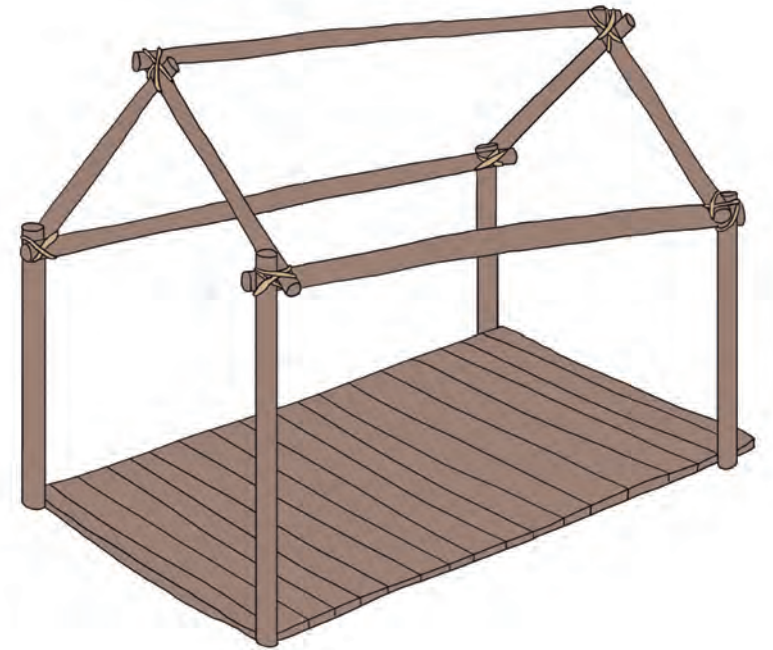

Min cuëmëdaid:

Atoda ayashën napec

Bacuëbo ismequid chido chiaid:

Chuiban bacuëmpibo shëdë icaid chuimequin ma aidëntsen ambi tantiaidtedi chuibanu. Umanuc puduen bacuëbobëd shidë nibë nec. Adotanquimbic istuidshun chuiban midambo iquec. Midambo aton podquiedën nidannec neque isban quequin.

Chuiban:

- ¿Ada shëdën podquied tsibambanquin isonda?
- ¿Midambo nidec?
- ¿Midauëshquio unësec?
- ¿Tsundan tantiec ayash chiaid?

Cute nibën ayash diadquid. Adoshombic chuime nëid ayash nec quequin, ma chuinu dadauanun. Chuiban aton buchidon adec shëdë unësec quequin chuibued. Aton nitempi ayash yanec quequin. Utsi nua iquec, utsibic pictsëc utsibic ënapenquio, utsibic bushcuctsëc.

Adembidi chuiban mitsipaden ayash tës pec bushcuctsëc tësëdenquio yec ma ënapen tësëdnu qeshun.

- ¿Atoda nate ayash nepec?
- ¿Mitsipaden ayashën napec?

Adoshombic mitsicquid ayashën buintadbëta cuate daëduaquin tanepec. Midacquid ayash tsitsan daëdcate neuapec.



Istanquin dadaua:

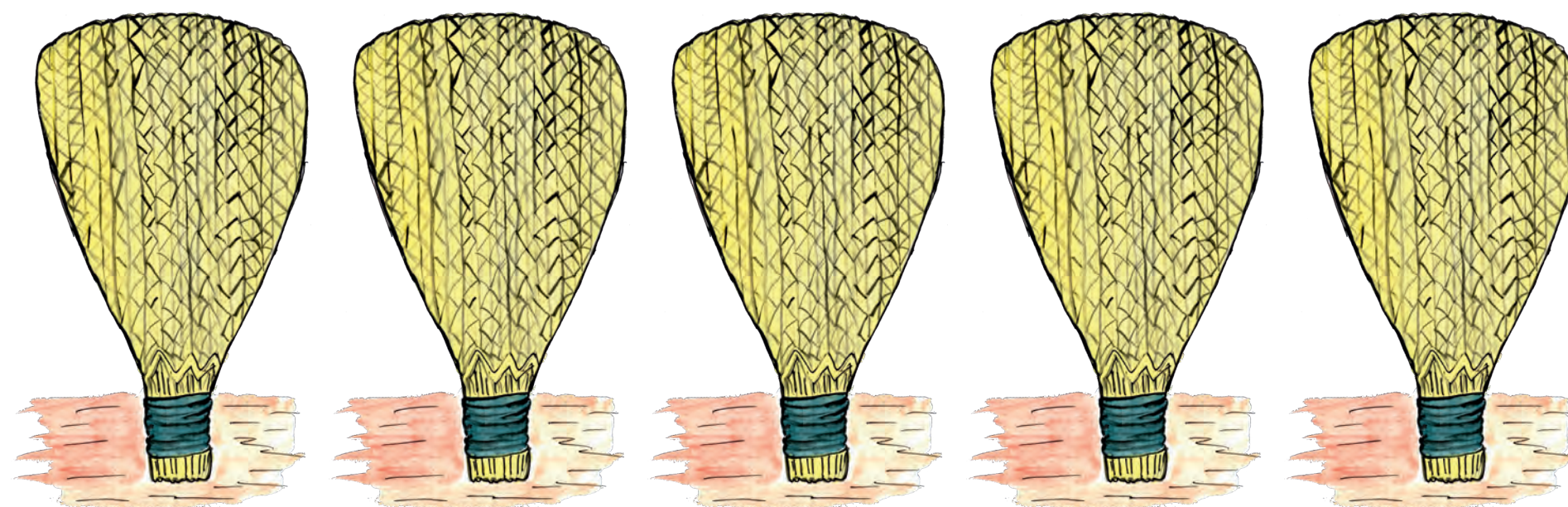
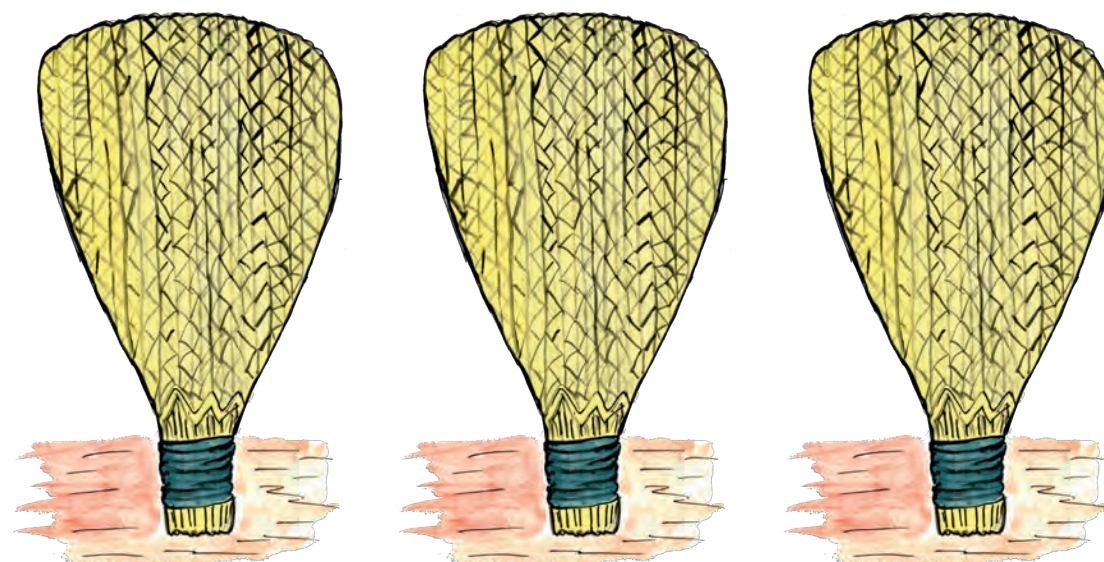
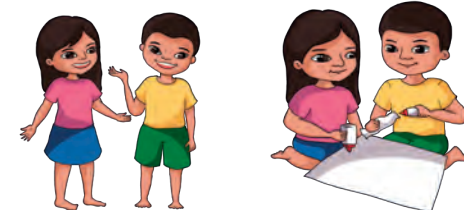

Min cuëmëdaid:

Mamënuna shuccaten

Bacuëbo ismequid chido chiaid:

Bacuëmpibo chui ma shuccate icbo-icboen bënu.

Bacuëbo ismequid tsidadash bacuëmpibo champichedobëd mamë nec dashuccananec. Bëyuc dabushcananec. Adtanec shuccatentsen dashucquec. Chuiban: ¿Midacquidën acquiepambo cuncaic, bushcac o shuccaten shuccac? ¿Atoda utsi nate shuccate neuapec? ¿Mitsipaden daëdcapec? Bacuëbon aton shuccate isquin chuibanec. Adoshon ambi shuccate daëdcasho isbued chuinanec.

Mamën bacuëmpibobëd dashuccananec. Shuccate dada tedishuna tsinacac:

- ¿Tedtsi icpatsiash?
- Chido tedishun shuccate tsinacac ¿Tedta icpatsiash?

Atoda natiad shuccate 5 tedquio icmenuen.

- ¿Tedta daëduac bëdambo icpec?

Bacuëbo meneban dadauate shubu nuntan icquid. Nadquid ictsiash, cuembo tambante, mamënte, sedunte bëchudante chedo.

Adoshon chuiban:

- ¿Tedtsi ismete iquec?
- ¿Tedtsi padabi iquec 5 ted yante?

Tsiuec bëca icquidën sauan nibën A3.

Tedta shuccate daëduashun bedshunuac bëdambo icpec, 5 tedquio sinaid abi daëdën icmenuen.



Istanquin dadaua:

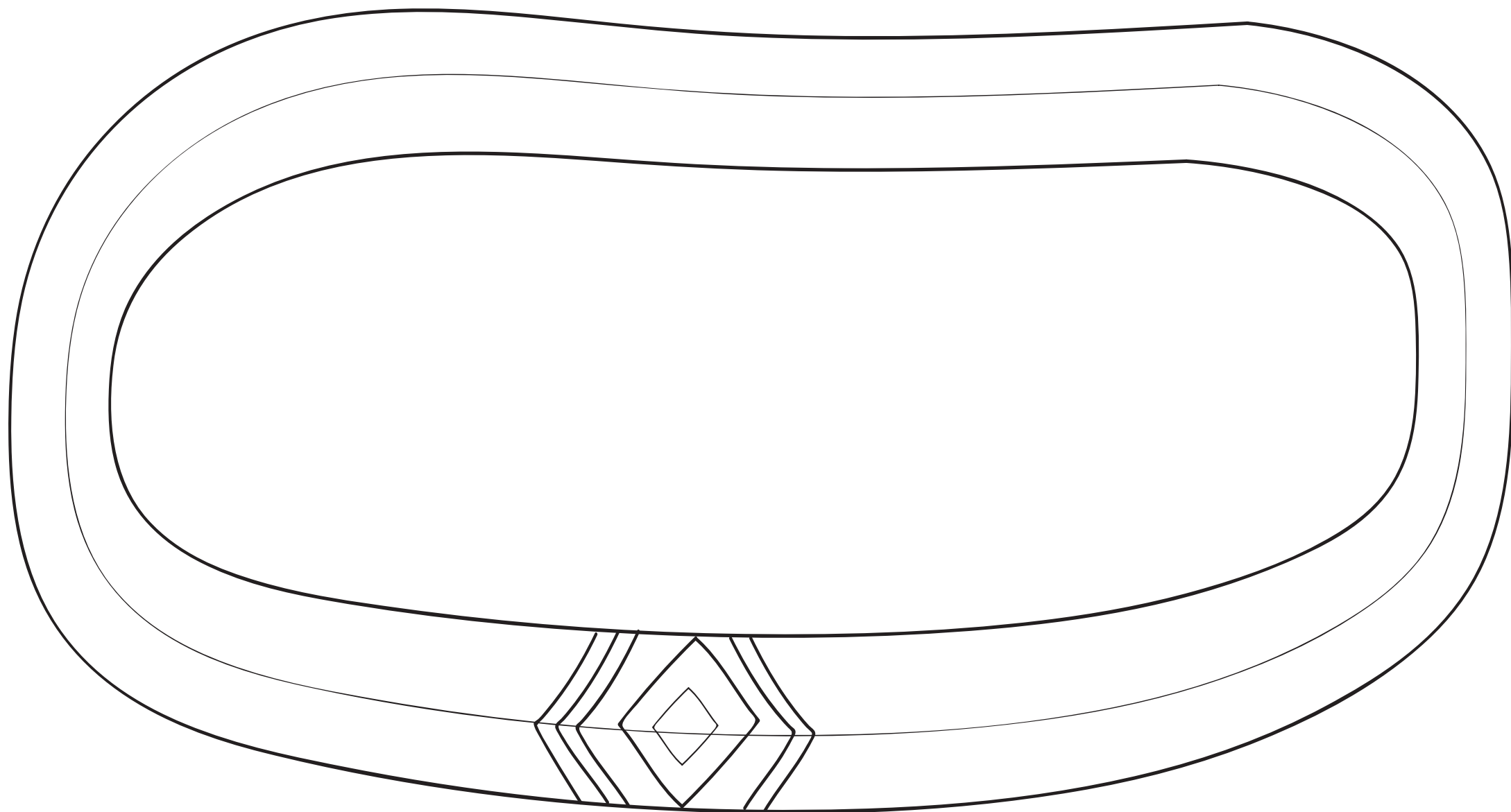
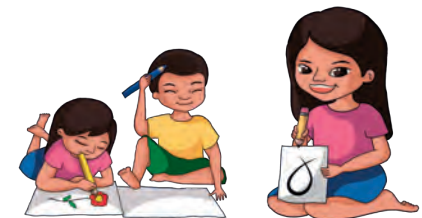

Min cuëmëdaid:

Tote daëdcanuna bacuëmpi dete

Bacuëbo ismequid chido chiaid:

Bacuëmpibo chui naden: ¿Tsundan utsi bacuëmpi iccosh? Bacuëmpin champibëtan ëcbednubi abi chuiban.

Chuiban mitsipad min utsimpi iccoshe.

- ¿Titanda abentsëqui nianosh?
- ¿Tied nantan nidquin mitsipaden titan bacuëmpi buanosh?
- ¿Midapaden cuëmpec bacuëbo dedonon daëcaid?
- ¿Mitsipaden daëdcapec?
- ¿Ada iso bacuëmpi dedote tote daëcasha?
- ¿Ada tantie titan mibi dedote tote daëdcaid?
- ¿Tedectsi ushqin bacuëmpi dedote tote daëdcaush?

- ¿Ada bacuëmpi dedote tote nate bune? Isban min dadauate ada aton bëdiuaid abitedimbo bëdambo isadeque.

Tote bëdiuaid dënainquin bëdiua. Adoshon titan cuëmëdaid dadaua tsidion sinaid icquidën.



Istanquin dadaua:

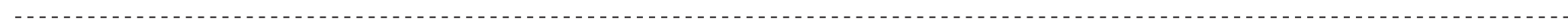
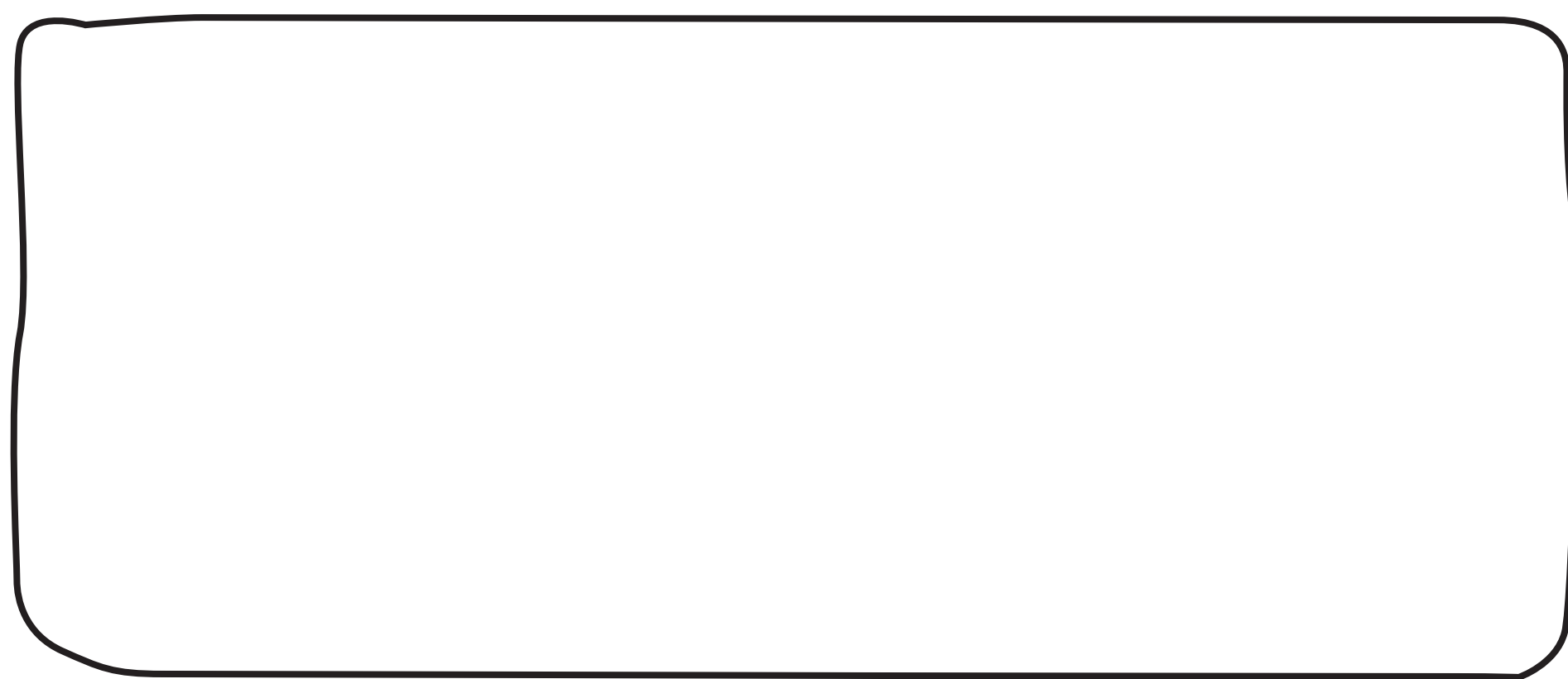

Min cuëmëdaid:.....

Macubobëd tsasibo

Bacuëbo ismequid chido chiaid:

Macubobëd tsasibon sauan naid icquid nacnen. Adoshon madin shubumpin sando.

Bacuëmpibo cuën ma abitedi tiqiuiaic tabadnu. Adoshombic chui mimbi bedte bëdaiquio iquec, quequin ma aton matsesbëtan isnu.

Adotanquimbic chui ma papedëmpi abentsëc madin shubun icquid bednu. Adoshombic isenquiocquin ma sanannu. Abitedimbo aton papedëmpi bedmetanquin chui is atoda nec quequin.

Aden istanec midapadeque is. Adoshon chui atoda nec mimbi bedaid quequin. Isambo iquembi qesho utsitsen bedme madin shubun sandued icquid. Bacuëbo ambi isaid icnuc bëdambo yacno cuëscaquin.

- Chuime ada aton matsesën cuëmëdaid tantieque.
- Adoshon tsasiboda min matses niosh o macubo quequin chui.

Min mauete bëdiua “min tëbo” caid icacpad isadnuc. Adoshon cuëmëdaid dadaua sinaidën.



Istanquin dadaua:

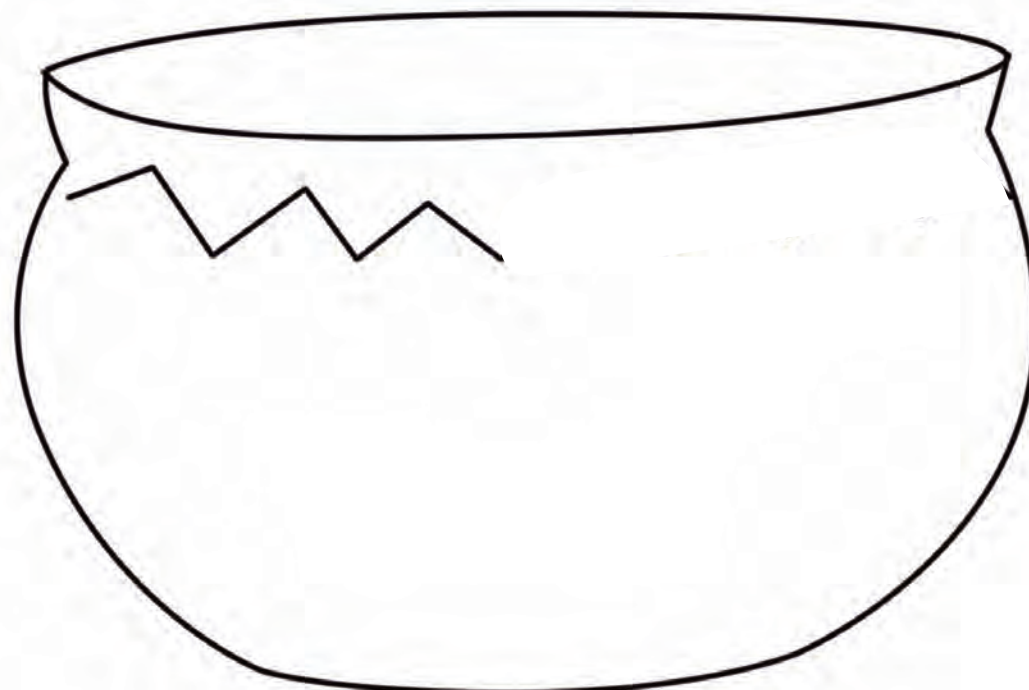
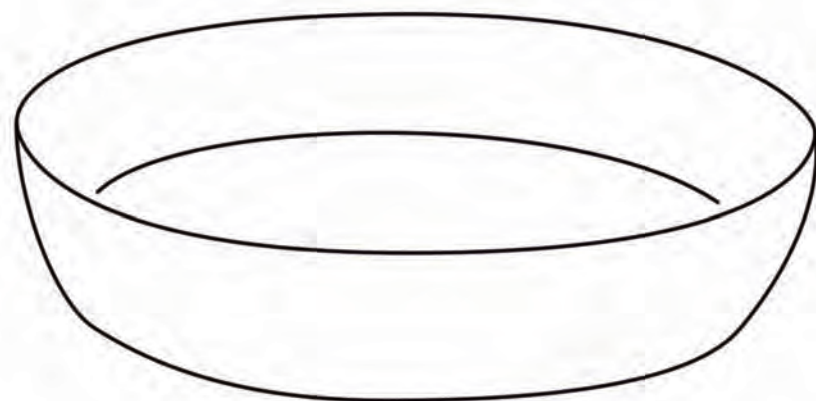
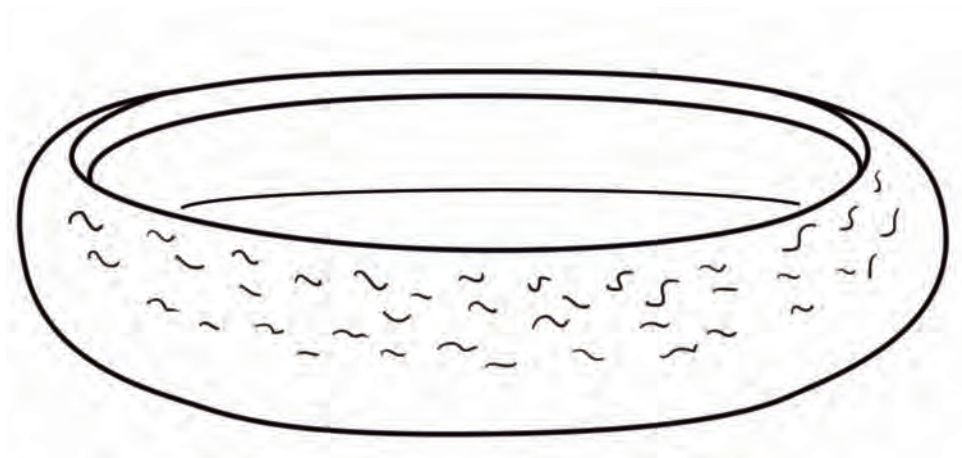

Min cuëmëdaid:

Matsu nacnente nidaid ushu istuidnëdaid

Bacuëbo ismequid chido chiaid:

Badiadshunn natequid icnuc istuid, shocoshëmpi o matsumpi nidaid nacnenaid. Adoshon bacuëbo chui ma cuenadec tabadtono. Adash aidon bëyuc nidto. Adoshon matsumpi ismequimbi naden chui.

¿Atotsi naid nec? Adoshon bëdambo ictsëcquid ënden chuinëdaid mibi chedo tantiamembi quequin chui.

Icpanëdash macho abentsëc codocate bunquidquio. Adecbidi matsu nacnente bunquid, maspan nacnente bunquid, padapadaid chedo nacnente bunquidquio. Adshumbic aton baba chiondash, naden nimëduc nidnu nid, acte cuidi aniactsëcquid istuidec quequin. Ambo nidaid bëdambo ictsëcquid iquec quiash abidaëdi cuishonquequiec acte cuëman nidanniondash. Ambo nidshun isac masiuidquio icpanëdash. Bëdapenquio icquid nec capanëdash aton chin.

Adsho aton baban nadopanëdash, adembi udictsëc nibënuna acte cuidi yacno ëquëduc uëdëshcashun nibënquin capanëdash. Adanec nidquin istuidpanëdash. Nidaid bëdamboshë icquid. Aid nidaidën utsi tedi nacnempanëdash: matsumpi, pada-padaid, tëchumpi chedo. Adanec chuishonquequiec nidquin machon aton baba chuipanëdash, nëid nidaid ushu nendac baba quequin.

Chuiban.

- ¿Ada ënden chuinëdaid bëdambo iccosh?
- ¿Midacquid matsu nacnente buntsia?
- ¿Midapad isadquidën danoshcatsia?

Matsumpi bëdambuen tëbëdiuatsëc. Adoshon padapadaidbëta maspan annoshca.



Istanquin dadava:

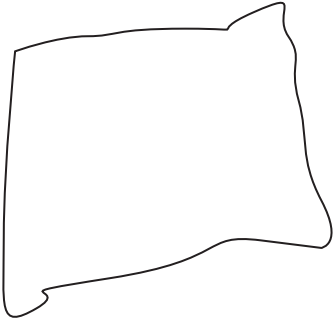

Min cuëmëdaid:

Utsi-utsiec nocoshcate nimëduc icquid iquec

Bacuëbo ismequid chido chiaid:

Aton tita abentsëc chomequin matsesën nacnenaid nocoshcate utsi-utsien naquin tantiaquid.

Ma utsi-utsien buanec nidnu (piute, chëshëte, o piuuate).

Meneban utsi-utsiec isadquid annoshcate dadauate sante yacno matsumpi aniactsëcquidën cushtobanshun, sedquid tëshun, adembidi dashcute cuëshëmpi. Adoshon atoda nec quequin chuimetanquin ma danoshcabannu utsi-utsiec isadnuc.

Bëdambuen dayunua bacuëmpibon abi mamënte meniaidtedi.

Chuiban: Midapad mimbi nabuedo yanosh.

- ¿Mitsipad isadosh sedquid?
- ¿Dashcute cuëshë?
- ¿Ma shiadshiadquid?
- ¿Nëbi midapad yanac utsi-utsinquin annoshcac?
- ¿Mitsipad yanosh nocoshcate?
- ¿Mitsipad isadquid niosh?
- ¿Abitedida danoshcabanac?

Bëdambuen is tëshquën icquid. Adoshon annoshcaban abi isadac paden abi yacnombo. Adoshon chui midapad yaneque.



Istanquin dadaua:



Min cuëmëdaid:.....

Anquiadacsho iste

Bacuëbo ismequid chido chiaid:

Tiquiduaquin bacuëbo tabëc. Adec tabadquin dadauamequidën chuibanec bacuëbo abi anquiadaid. Ma bëdamboen tantianu qeshun bacuëbo ismequidën naden chuibanec:

- ¿Midacquidtedi nuqui isedpo?
- ¿Tsuda chedo nuqui isedpo? ¿Adembidi tsuda chedon nuqui isedposh?
- ¿Atoda nuqui ismeposh?
- ¿Atoda nuqui tantiacmaid anquiadpo?

Bacuëmpibo ismequidën menebanec. Bacuëmpibon ambi nabante utsi-utsien ma sauan nanu qeshun. Adembidi ma annoshcanu qeshun. Adecbidi abi ushë abentsëquën anquiadaid tantiec ma utsi-utsien chiec onquenu qeshun.



Istanquin dadaua:





**¿Atoda natiad nuquin nuëcquid
uesadnushe queshun?**

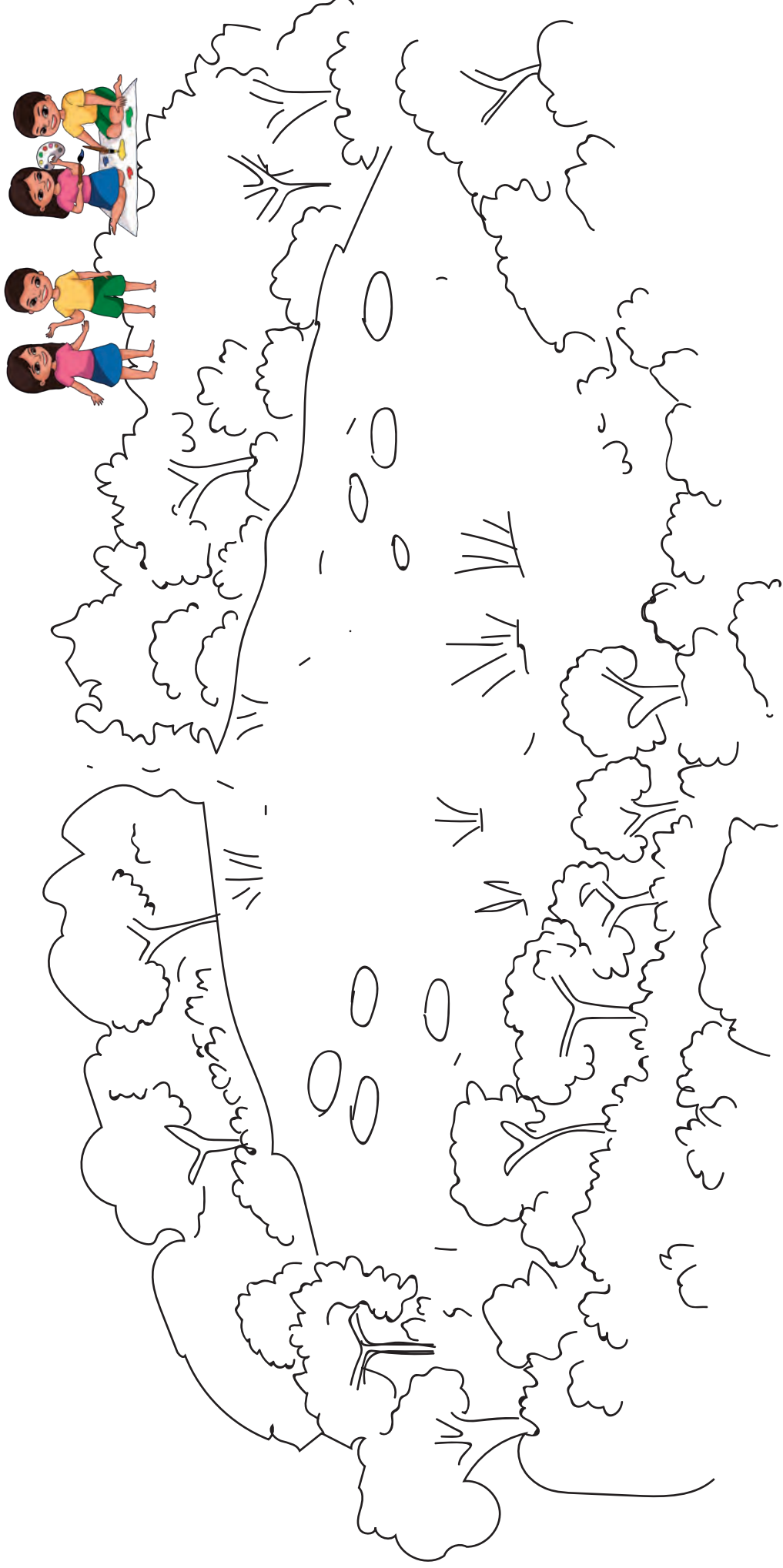

Nuëcquid yanaid chiaid tantianuna

Bacuëbo ismequid chido chiaid:

Menabo iccuededpac cadennec. Adnubic uesnid matsesanec chobuedën nuëcquid ancuesnu quec nidannesho tsibampac caundash. Midapaden naique isnu qeshun.

Menabo nidannepampic, ambi ancuesnu cacno. Ashunquio ancueste dadpen timpac caundash.

Adec iuecquio icsho issun uesnidën chuipac caundash naden: aden naquin mimbi nuëcquid bedenquio iquec, cueste ënapen icquid tetan capampic.

Adoac menabon cueste ënapen icquid tetanec choquin uesnid menepampic.

Aden cueste meniac bedshun uesnidën acte nënantanquio cute uequidën nidquin nënantanquio pumbucpampic.

Adonobi acte badedquio uesadquidën dadpenquio nuëcquid icpac caundash,

pesquedequetsëcquiec.

Adsho issun menabon dadpenquio nuëcquid bedbededpac caundash. Sambudtannetsëcquien.

Aden uesnidën menabo nuëcquid bedquin ismepac cadennec.

Bacuëmpibo chui: ¿Tsundan nuëcquid bedquin matses ismepampic? ¿Atondan nuëcquid bedte bumpampic, menabo?

- ¿Midambo nuëcquid bedpampic uesnidën?
- ¿Midapaden matsesën nuëcquid bedec nëbi?

Ambi nabantequid dadauate menebanshun, ambi tantienquio icaid istuidquin nashun.

Midashun uesnidën nuëcquid bedquin ismenëdaid iqueque chui. Adoshon annoshca.



Istanquin dadaua:



Min cuëmëdaid:

Nuëcquid bedtequid icnuc icaid

Bacuëbo ismequid chido chiaid:

Onquecueded bacuëmpibobëd acte uesadnuc icaid chiec. Adoshombic naden chui:

- ¿Atotsiquiash acabëd chadac acte cuëman icpec?
- Bacuëbobëd umanuc puduen mamëncuededec.

Adash tiquidiuaic tabadquin chuime nëbi nuqui chian cuëman acabëd chadac tabadacimbuec nec quequin. Adoshon naden chui:

¿Midapadec acte cuëman aca tsadpec?

Adoshombic chui, tsidad aca dadampiuidquio, aca, chidompiuidquio quequin.

Adashic manëdaid ënapen icquiduidquio, manëdaid bushcuctsëcquiduidquio quequin.

Adec dashcute abi padquiduidquio dasiuidquidtsen tsidadnidequi aca acte cuëman tsadacimbuec tabadnidec.

Dadauate shubu yacno choshon ambi natequid nabantequid nacenaid meneban ma abiuidquio tsinacbanquin nabannu.

- ¿Atotsi acan naic acte cuëmanshun?
 - ¿Mitsimbo nuëcquid icpec?
 - ¿Midapaden nuqui tsinacpatsia?
- Tsiuec bëca icquidën sauan nibën A3.

Nuëcquid nuacquidbëta aniactsëquidëmpi bitaccaban.



Istanquin dadaua:



Min cuëmëdaid:.....

Nuëcquid bedquidquio icnush niaid

Bacuëbo ismequid chido chiaid:

Nuëcquid ansemequin tantiaquid yacno nidshun tantianush nacnemëdcueded. Ambo nidash bëdambuec tabadnuna quequin chui.

Nuëcquid bedquin, adembidi ansemequin tantiaquidënuquo nuëcquid mapi chenda ansemequidquio icnun quequin chuibanec. Adembi acaten chedo siadquid nuëcquid ansemequid icnuec chedobi.

Dadauate shubu yacno chouashun naden chuiban:

- ¿Atoda iso?
- ¿Atoda mimbi natiadquio icnuc chuibanosh?
- ¿Ada mibi chuibanosh nuëcquid ansemequin tantiaquidën?

Sauan dadaua mibi caniaash icte bunaid.



Istanquin dadaua:

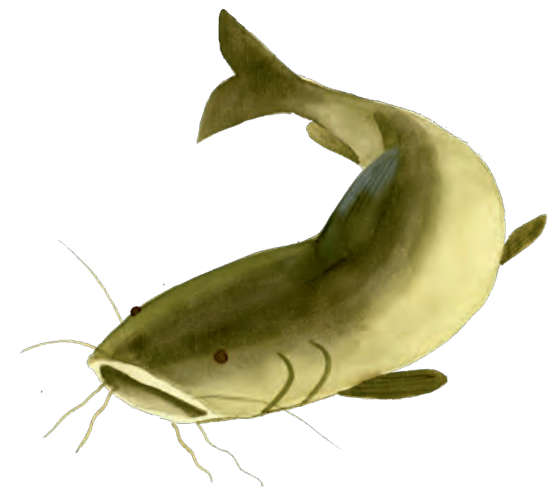
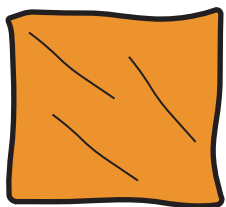
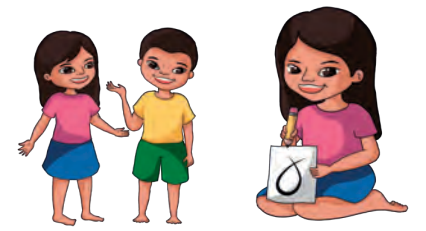

Min cuëmëdaid:.....

¿Atoda tëshën nuëcquid ansemetiad?

Bacuëbo ismequid chido chiaid:

Nuëcquidbitsecnuc utsi-utsien nacentanquin bacuëbo naden chuiban:

- ¿Atondan nuëcquid bedquin tantie?
- ¿Tsundan mibi ismiondash?
- ¿Tedtsi nuëcquid utsi-utsien isonda?
- ¿Atoda buampec nuëcquid ansemenun?
- ¿Atoda chequido nuëcquid nec?

Umanuc puduen-puduen. Adshun isme nuëcquidbitsecnuc nacenaid. Adash mamën nuëcquid ansemequin tanec. Nëid tëshën nëid nuëcquid ansemec, quequin tambanec.

Naden caimbi: nëid mani sinaidën bédichued ansemec, nuenëmbic, mësiانquid quequin.

Abimbo yacno simban midacquidën ansemetequid nuëcquid neque.



Istanquin dadaua:

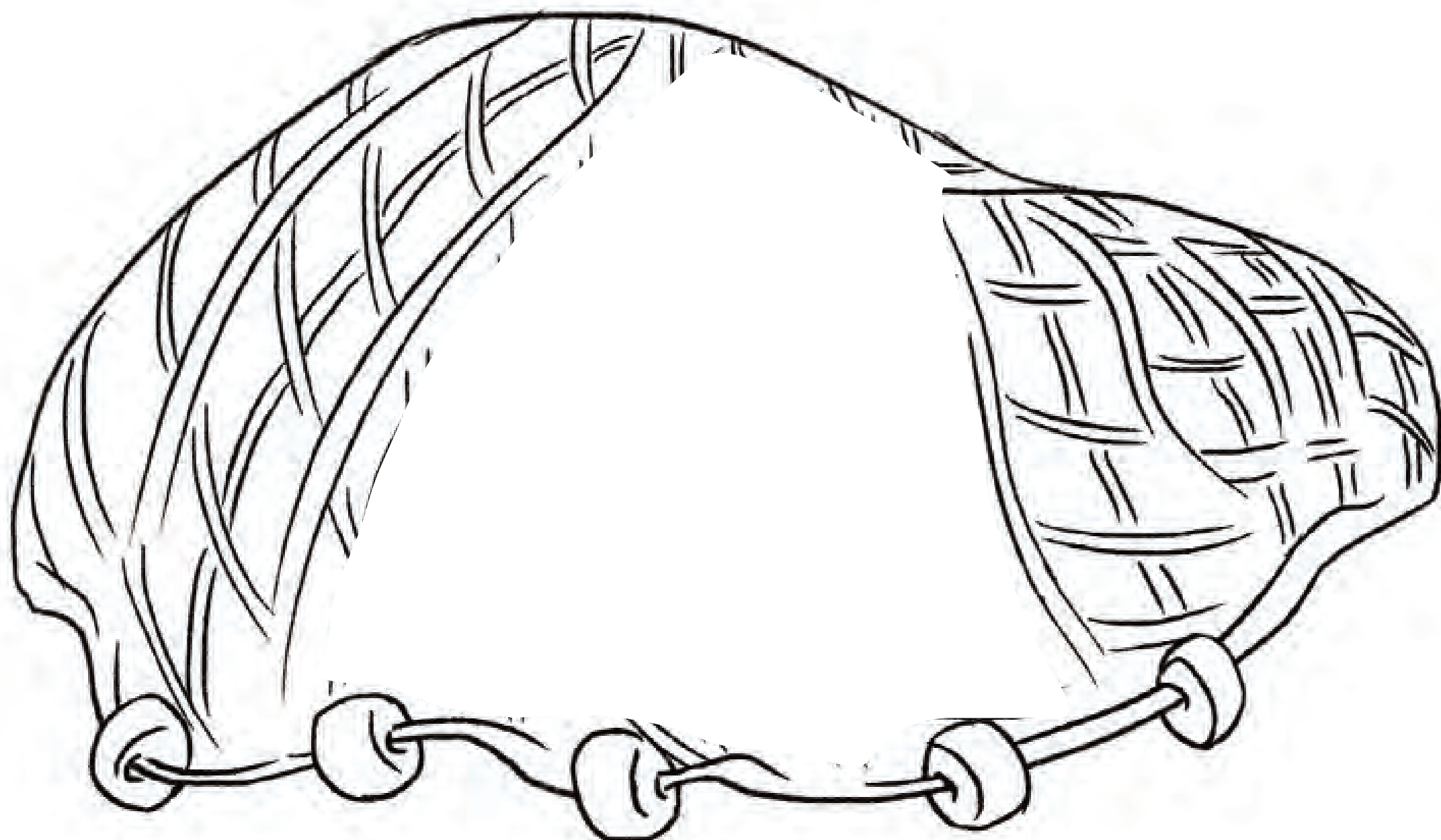

Min cuëmëdaid:.....

Nëshaidën nuëcquid bedaid

Bacuëbo ismequid chido chiaid:

Bacuëmpibo chui nëshaid nuëcquid bedte ada isnëdaque. Chuiban:

- ¿Midambo nuëcquid bedo nëshaidën?
- ¿Tsundan mibi ismiondash nuëcquid nëshaidën bedquin?
- ¿Atoda chidobon napec dadan nuëcquid bednuc?
- ¿Midapaden nëshaid tsedopec?

Chui cuembo bacuëmpibo, champichedobëta tedtsi nëshaid icpec, nuëcquid bedte quequin.

Bacuëmpibo isme nëshaidën sauan utsi-utsiec icquid ismequimbi ada cuembo tantiaque chuiban.

- ¿Atoda nuëcquidquio dadpen bedadpec nëshaidën?

Ambi nabantequid dadauate meneban. Adoshon ambi tantienquio icaid nashumban.

Tsiuec bëca icquidën sauan nibën A3.

Nainquin nëshaid dadaua. Adoshon aidën bedadquid nuëcquid bitacca.



Istanquin dadaua:



Min cuëmëdaid:.....

¿Atoda nuëcquid nuqui istuidpe chianën, actedapan, acte cuidin?

Bacuëbo ismequid chido chiaid:

Bacuëbo ismequidën chuibanec, bacuëmpibo, champichedobëta: atoda nuëcquid nuqui istuidpe chianën, actedapan, acte cuidin quequin.

Ada nuëcquid utsi-utsiec icpec nuacquidtapa aniaactsëcquidëmpi quequin.

Nuëcquid bedquin tantiaquid chome, ma bacuëmpibo, champichedobëta chuinu, midapadec nidpec nuëcquid bedec, midambo nidpec quequin.

Bacuëbo ismequidën bacuëmpibo naden chiec:

- ¿Midambo nuëcquid bedec nidpec?
- ¿Atoda nuëcquid chianën icpec?

- ¿Tedtsi nuëcquid chianën icpec?
- ¿Atoda nuëcquid actedapan icpec?
- ¿Atoda nuëcquid actecuidin icpec?
- ¿Midambo nuëcquid bedec nide?
- ¿Ada chianën nuëcquid bedpec?
- ¿Acte cuidi chedombida nuëcquid icpec?
- ¿Atondan nuëcquid bede?
- Ambi nabantequid dadauate meneban. Adoshon ambi tantienquio icaid nashumban.

Nuëcquidën sauambëta acte cuidi dadaua.



Istanquin dadaua:

Cun cuëmëdaidbëd cumpan cuëmëdaid

Bacuëbo ismequid chido chiaid:

Nabanteno bëyuqui bacuëbo aton DNI bëdambo isadnuc chicshun bëbëta quequin chui.

Cuëdën cuëdënte cun cuëmëdquid quequin cueuacash.

Nëbi anquiadhuna midapadec nuquin cuëmëdaido iqueque.

- ¿Mitsipadec cuëmëde?

Ubi cuëmëdebi.....cumpa chedon cuënondashi, ma adec cuëmëdnu qeshun. Nëbi bëdambo iquebi cun cuëmëdaid iquec.

Bacuëmpibobëta champibo chui:

- ¿Midapaden chiec cuëdënte iquec?
- ¿Abitedi bacuëmpibo champi chedobëd aton cuëmëdquid iquec, abi cuëmëdaid tsibanquidbëdi?
- ¿Tsundan mibi cuënondash?

- ¿Ada tantie midashunquio DNI chichte dadauamepec?

Bacuëmpibo tsësiödapan DNI isme. Adoshon chuiban tsundana nec quequin.

- ¿Tsundana nepec?
- ¿Atoda dadauaid nuqui istuidpo?
- ¿Abiuidquioda DNI icpec?
- ¿Midapad icpatsiash nuquin DNI nibëdnuc?

Paped tsasimboctsëcquidën bacuëbon cuëmëdaid daduabanshun meneban. Adoshon abi bunacpaden bëdambo ictsëcnuc cuidadauabantsëcquin nacnen.

Min shubun icquid ismequin min cuëmëdaid dadaua. Adoshon min sauantsen dadaua.



Istanquin dadaua:

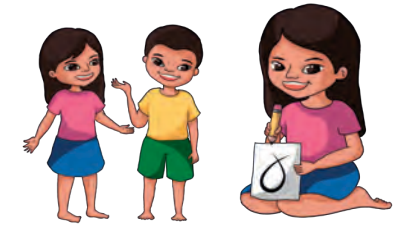

Min cuëmëdaid:.....

Nuëcquidbëta pete codocate

Bacuëbo ismequid chido chiaid:

Bacuëbon tita chome dadauate shubu yacno ma aton bacuëbo nuëcquidbëta pachid codocaquin ismenu.

Adoshon bacuëmpibo naden chuiban:

- ¿Atotsibëta titan ambi codocaid chuisho tantio?
- ¿Mitsipadombuen codocanun titan tantiapec?
- Pete codocaquidquio iquec, ¿mitsipadquio tita chedo icpec?
- ¿Atotsibëta tita chedon codocaid pebededo?
- ¿Atontsin titan codocaush?

Codocaid dadpen icnuc,

- ¿Codocashun ambentsëquida tita chedon pebededpec?

Ambi nabantequid bacuëmpibo dadauate meneban, ma ambi tantiabued sauan abibimbuecnuc dadauashun annoshcanu.

Nuëcquidbëta pachid codocate dadaua.



Istanquin dadaua:

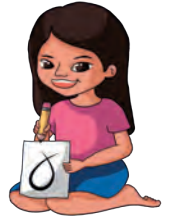

Min cuëmëdaid:.....

Anquiadacsho iste

Bacuëbo ismequid chido chiaid:

Tiquidiuaquin bacuëbo tabëc. Adec tabadquin dadauamequidën chuibanec bacuëbo abi anquiadaid. Ma bëdamboen tantianu qeshun bacuëbo ismequidën naden chuibanec:

- ¿Midacquidtedi nuqui isedpo?
- ¿Tsuda chedo nuqui isedpo? ¿Adembidi tsuda chedon nuqui isedposh?
- ¿Atoda nuqui ismeposh?
- ¿Atoda nuqui tantiacmaid anquiadpo?

Aden tantiaquin bacuëmpibo ismequidën menebanec. Bacuëmpibon ambi nabante utsi-utsien ma sauan nanu qeshun. Adembidi ma annoshcanu qeshun. Adecbidi abi ushë abentsëquën anquiadaid tantiec ma utsi-utsien chiec onquenu qeshun.



Istanquin dadaua:





Tied naid



1

2

3

4

Min cuëmëdaid:.....

Uesnidën matses pete ismebenaid

Bacuëbo ismequid chido chiaid:

Bacuëmpibo dadauate shubu yacno bédambuen tabëc.

Adoshon bacuëmpibo ënden uesnidën menabo pete ismepampid chuiban.

Menabon pete isbenabicquin cute bitsi nidaid cabiunquin shëaidi pepac cadennec. Adec iquequi capuec nidquin tantiac uesnid uinsho tantishun senuen chuuaqui aidi onquiampac cadennec.

Senuen bushcanten cute seshunac “ubu tsitëcanenda” quepac cadennec nidaid yacno ispambuec tsadec.

Adsho tantianec aucbidi badedi choshon ani chuituidac, ambo nidshun mibishë matsesuashun capac cadennec.

Adotamboc matsesash uesnid chopac cadennec. Adec chuash tsadsho “mui” shëaid menepac cedennec.

Aduac bushtequin istanquin nec “peten mëyadtsequien mibi nec menabo” quepac cadennec uesnid.

Adbosh badiadash pete isec nid menabo mibi ismenu quianec, menabo buanec nidpac cadennec. Adec ënapen nidquin tied istuidpac cadennec.

Aid tiedën dadpenquio pete icpac cadennec. Adsho menabon mani bitsi chobi chesho istanquin naden chete nec quequin ismebampac cadennec. Tiedën icquid tedi. Adash pachid tanedapabi bëbëec chochopac cadennec. Ambobi matsesën tiedën icquid pete isbempac cadennec.

Tsiuec bëca icquidën savan nibën T2.

Uesnid chuinëdaid chuiban ënëdacno utsiuatsëcquin.



Istanquin dadaua:

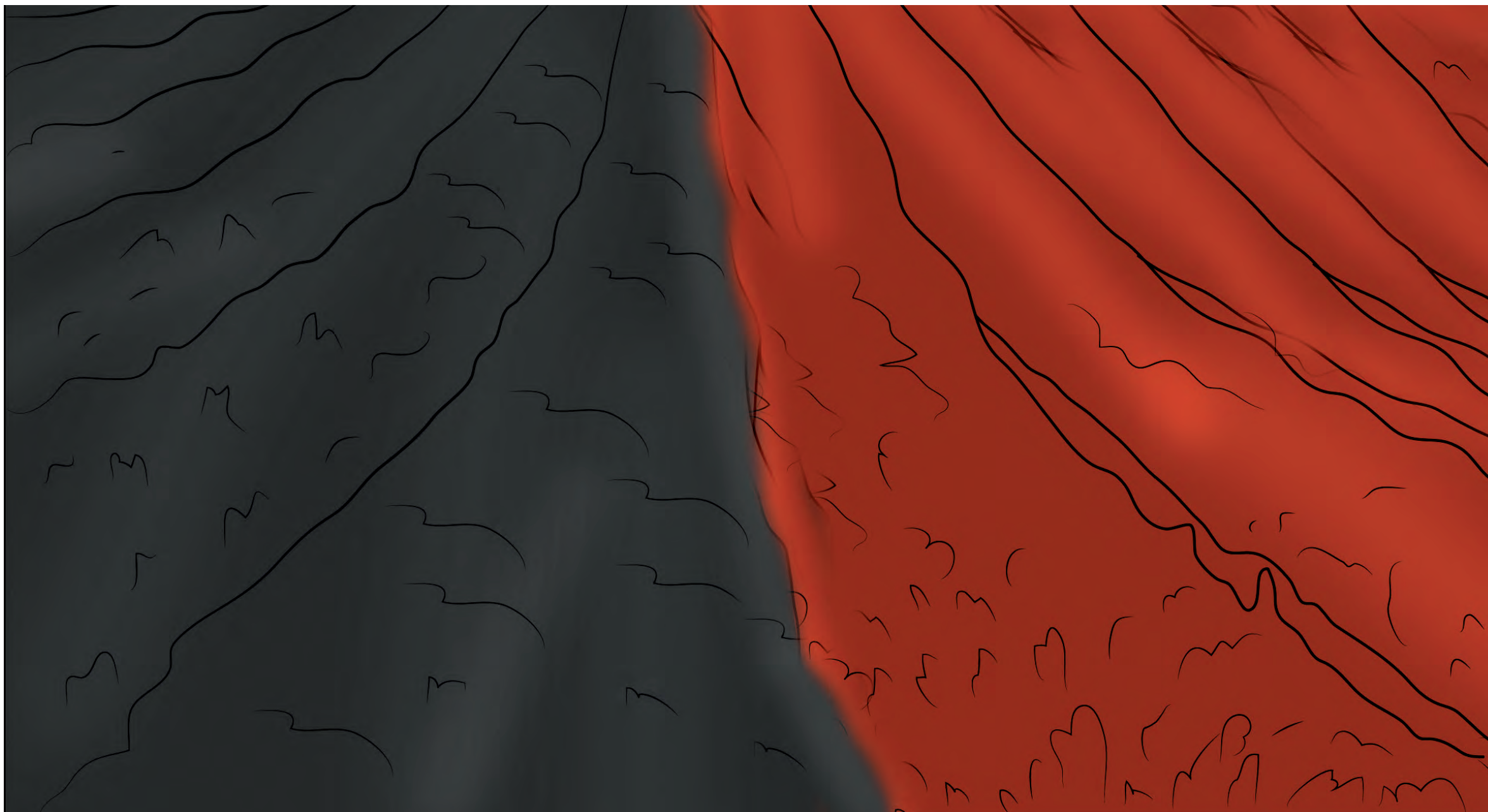

Min cuëmëdaid:

Utsi-utsiec nidaid iquec

Bacuëbo ismequid chido chiaid:

Tsidad tied nëbi yacno nidannenush. Nidaid sandonon baddempi buanec. Tsidad tedi-tedimbuec nidaid bēdambo icquid sandonosh. Auchidi dadauate shubu yacno chochoshon mimbi bēbued nidaid beccho quequin, chuibannun:

- ¿Atondan nidaid utsi-utsiec isadosh?
- ¿Midapaden nidaid bēdambocquid nec quequin tantiapec pete nitsinun?

Chuiban nidaid bēdambo icquid utsi-utsiec isadquid nëid nec quequin.

Nidaid chēshē bēdambo icquid nec piacbo sete, mani nitsinte, quequin.

Nidaid piumbic piabata bēdambo caniquid quequin.

Tiedën caniquidën sauan dadauaban, midacquid nidaidën caniquid neque.



Istanquin dadaua:



1

2

3

4

Min cuëmëdaid:.....

Tied nabedaid

Bacuëbo ismequid chido chiaid:

Bacuëmpibobëtan tied nëbi icquid, yacno nidanneshun istan.

- ¿Ada tantie mitsipaden tied napec?

Bacuëbon tantiec mitsipadombuen tied sëuënec, mitsipaden dëdec, mitsipaden tied abichobi nëdëncaic, mitsipaden tsinduec champichedon tantiec sicaidbëta pete menebanec quequin.

Dadauate shubuno choshon mitsipaden tied napec quiash mamë nec bëchish samëdquid tsidec. Adshun umanuc buanshun pichicaic.

Tsiuec bëca icquidën sauan nibën T3.

Isbanquin nacentanquin bitaccaban, tied naquid sauan icquin.



Istanquin dadaua:



Min cuëmëdaid:.....

Cute dëdquin tanec mamënnuna

Bacuëbo ismequid chido chiaid:

Onque bacuëbobëd mitsipaden papachedon cute dëdshun mëtepec pete nitsinnun quequin chiec.

Dadauate shubu umanucuësh 4ted tsidad 4ted cuate aniambocquid, amëpambocquid mamënte abentsëc pictsëcquid quequin meneban, tsidadash tabadquidtedi.

Meneban bacuëmpibo cuate abitedi ma nidaidën tabëcnu mamëntempin sequin uebudmëbanec mamënnun.

Ambentsëqui bacuëbon tanec uebudmequin.

Adec mamë nec ënëdshun, nuacquid, aniambocquid, aniactsëcquid quequin utsiuaquin sanec.

Icbocpadquiobidi icnuc sanquin.

Tsiuec bëca icquidën sauan nibën F1.

Nacnen 5ted nuacquid tapa bedanquin aniactsëcquid cuëscaquin. Adoshombic aniactsëcquid bedanquin nuacquid tapa cuëscaquin.



Istanquin dadava:

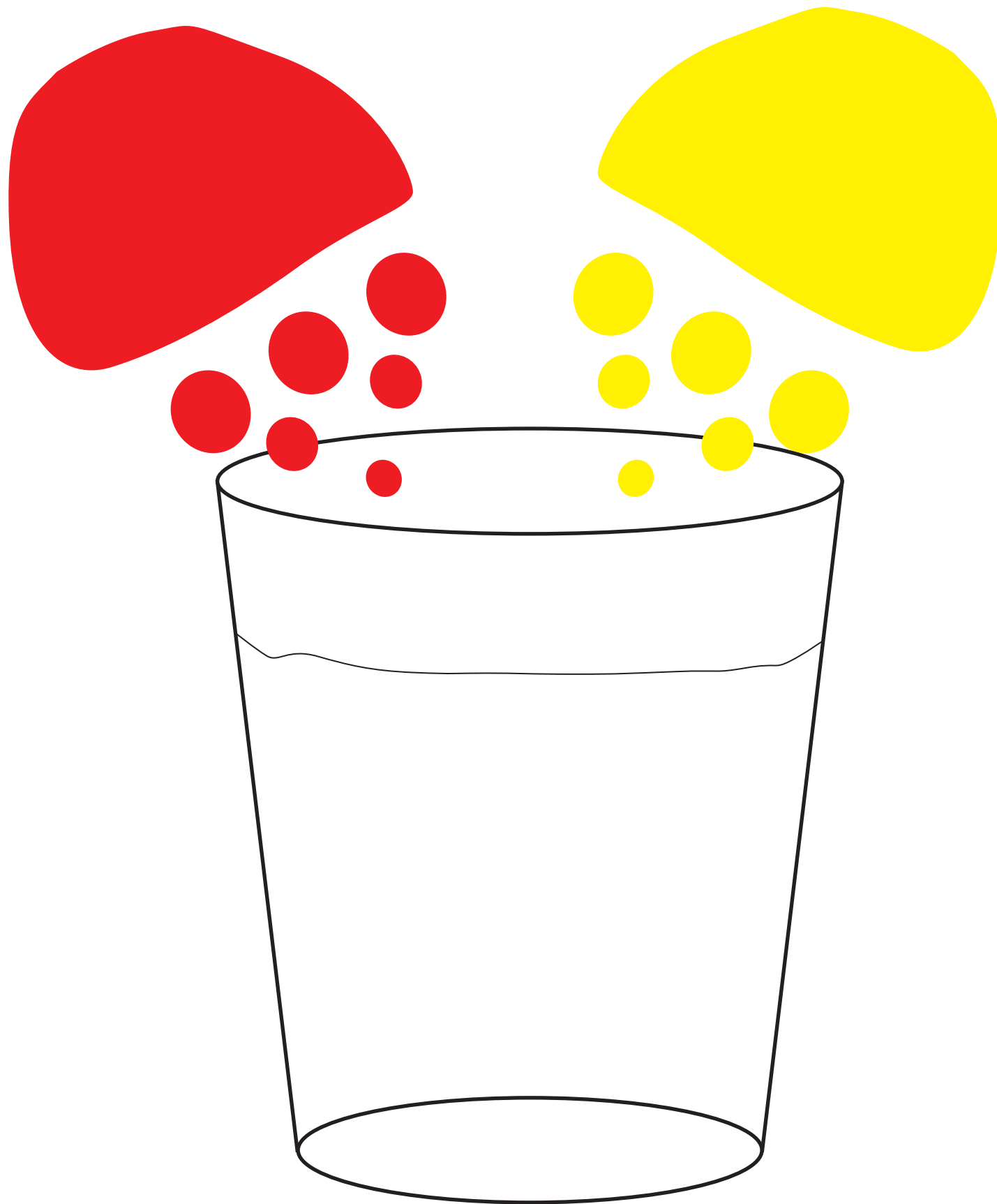

Min cuëmëdaid:

Nidaid masibëta natsusuanuna cadì nitsinnun

Bacuëbo ismequid chido chiaid:

Bacuëbobëtan dadauate shubu dayun nibën nidaid masiuidquio icquid.

Chuiban ma natsusuanu nidaid. Adotanquin chui atoda nac bëdambo icpec quequin.

Dadauate shubuno choshon mene: nidaid, acte, masi, tempeda quequin tsidadshun nabannun.

Natsusua nidaidbëta acte, actebëta tempeda. Adoshon nidaid is midapadeque.

Chui:

- ¿Midapad isadosh nidaid?
- ¿Midapad iccosh actebëd?
- ¿Ada natsusuatanquin cuësh-cuëshac bëdambo icpec?

Annoshcate mitsipad isadpatsiash dëshoten acte icquid cacushac.



Istanquin dadaua:

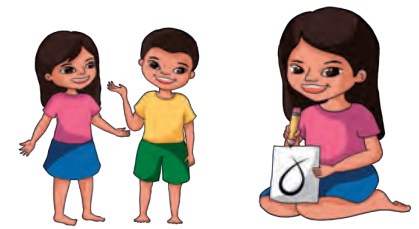

Min cuëmëdaid:.....

Midapadoquin yuca nitsimpec

Bacuëbo ismequid chido chiaid:

Buan utsi utsiec pachid icquid dadauate shubuno. Adshun bacuëbo chui tsidad quequin ma tantiashun nanu.

Chui atodaquiash pachid icsactsëcquio isadpec utsibic bédamboshë, utsibic nuambo quequin. Adoshon chui ma tsitënquin chuibannu:

- ¿Ada tantionda midapaduac pachid bédapambo shucupe?
- ¿Tsundan chuipanëdash pachid nadoquin nitsinte nec quequin?

Pachid tau chiec onquequin tantiame aton papachedon chiacbimbuen, naduac bédambo caniquid quequin.

Bacuëmpibo pachid nitsinaid tantiaquin bédambuen chuiban, ma tantiabannu.

Mimbi tantiac padembi pachid chuiquin dadaua.



Istanquin dadaua:

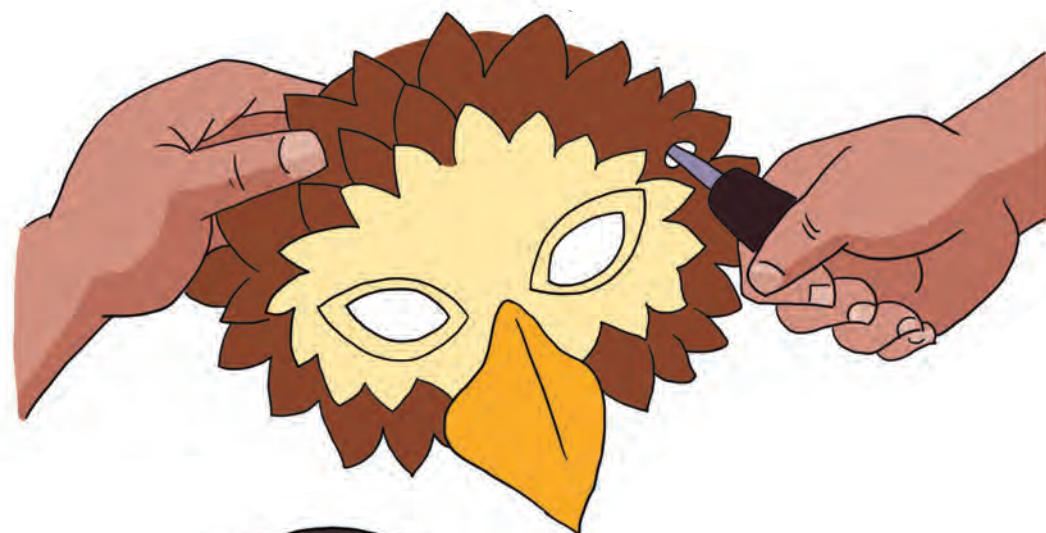
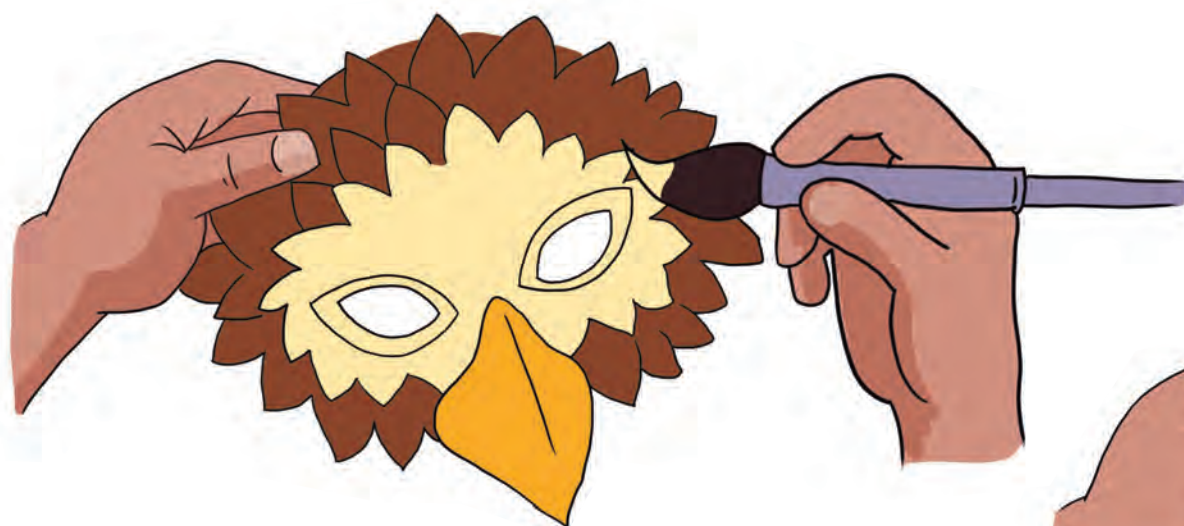

Min cuëmëdaid:.....

Tsistsis bēdambocquidbēdi icsambocquid chuiquid nec

Bacuēbo ismequid chido chiaid:

Bacuēbo chuiban nuqui icacno capuquin nuqui yacno icquid tedi isbannuna, quequin.

Adshun bēchicqueshun abuc isquin tantia atoda chedo cuēdeque.

Otacquio yacno nibēnash bacuēbobēd tiquidiuash tabad.

Adotanquin bēchicque ca.

Daduate shubu yacno choshon ambi tantiabued chuimeban.

Tsistsisbiecnuc nacnenaid isec onquequin tantiame bēdambo icquid, isacsambo icquidbēta chuiquid nec quequin.

CUĒDĒNTE

Ti ti tie,ti ti tie bēdambocquid icquid chuiquid nec.

Chi cua chi cua icsambo icquid chuiquid nec.

Tsiuec bēca icquidēn sauan nibēn F2.

Tsistsisbimbuecnuc min mapucudte nanenash cuēdēncueded bēdambocquidbētabi icsambo icquid chiec.



Istanquin dadaua:



Min cuëmëdaid:.....

Piacbon cuidaid

Bacuëbo ismequid chido chiaid:

Daduate shubu dayun shëcuë, shëcuë icnuc tiquidiuashun piacbo bacuëmpibo meneban. Adotanquin piacbo ansecaquin tamban. Adotanquin ada adec mamëntiadquio ique ca. Adoshon tedtsi piacbo ëshë ansecapec shëcuën quequin chui.

Mamënquin bedan: Bacuëbon tanec piacbo sec iccuededquin, cuesten sebansho 3 ted piacbo shëcuën ansecaic badedquio.

Tanec ënëdshun isbannuna piacbo umanuc paëdaid icnushe. Adembidi ada 3 tedquio shëcuën ansamëdeque isban.

Adotanquin shëcuë yacno penquio ansecaquid naden piacbon cuidec quequin bacuëbo tatiame.

Tsiuec bëca icquidën sauan nibën A4.

Piacbo ansamëdquid shëcuë annoshcaban. Adoshombic sauan dadauatanquin annoshcaban, piacbo midacquid shëcuen ansecatequid neque.



Istanquin dadaua:



Min cuëmëdaid:.....

Anquiadacsho iste

Bacuëbo ismequid chido chiaid:

Tiquidiuaic bacuëbo tabadec. Adec tabadquin dadauamequidën chuibanec bacuëbo abi anquiadaid. Ma bédamboen tantianu qeshun bacuëbo ismequidën naden chuibanec:

- ¿Midacquidtedi nuqui isedpo?
- ¿Tsuda chedo nuqui isedpo? ¿Adembidi tsuda chedon nuqui isedposh?
- ¿Atoda nuqui ismeposh?
- ¿Atoda nuqui tantiacmaid anquiadpo?

Aden tantiaquin bacuëmpibo ismequidën menebanec. Bacuëmpibon ambi nabante utsi-utsien ma sauan nanu qeshun. Adembidi ma annoshcanu qeshun. Adecbidi abi ushë abentsëquën anquiadaid tantiec ma utsi-utsien chiec onquenu qeshun.



Istanquin dadaua:





Tsidadash iccuededaid



Min cuëmëdaid:



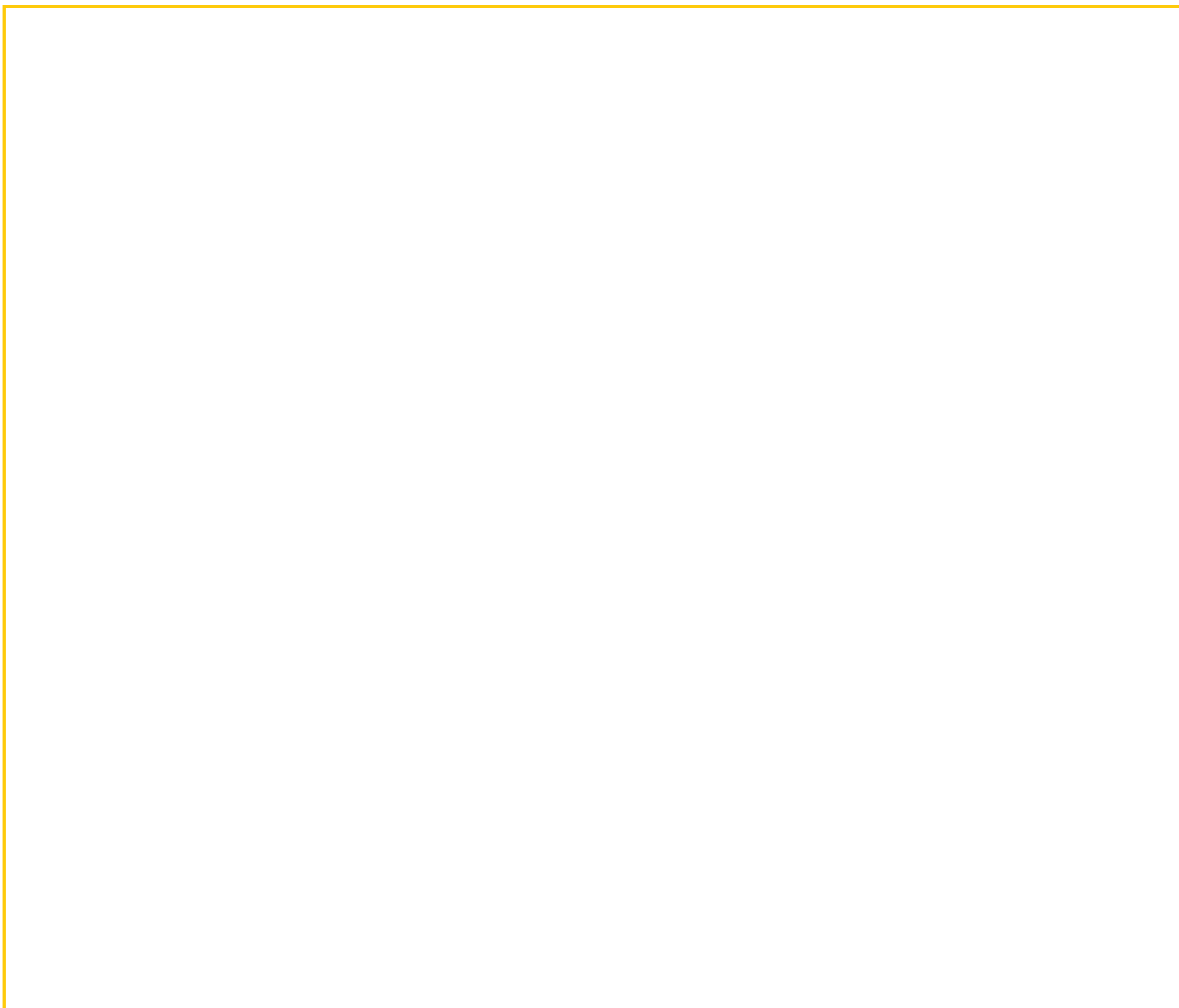

Min cuëmëdaid:.....

Matses abitedimbo iccuededec cuishonquecuededec

Bacuëbo ismequid chido chiaid:

Matses tsidadash tabadquin naid dadauaid icquid ismequin naden chuiban:

- ¿Atoda tsidadashun matsesën napec?
- ¿Midapad abi dasiuidcuededaid iquec?
- ¿Mitsipad abi tansiadaid iquec?

- ¿Midacquid tsësiodapa ëndenquio icnëdaid nec?
- ¿Tedta bacuëbo iccuededec?
- ¿Tedtsi champichedo iccudedacno iquec?

Tsiuec bëca icquidën sauan nibën 89.

**Bëdambuen isquin sauan dadauaid icquid sëdëquënquio buanquin tasban.
Adoshon adquiobidicnuc utsi bëcan bitaccaban.**



Istanquin dadaua:



Min cuëmëdaid:

Tsidadadash iccuededec nuqui dasiuidte nacenunna

Bacuëbo ismequid chido chiaid:

Bacuëmpibobëd onqeshun tsidadash iccuedec dasiuidte nacenaid icacno nidshun istan.

Adoshon shubu icbo chui ma bacuëmpibo chuibannu. Midapaden tsidadash iccuededec, dasiuidte nacenmpec, matsesëna quequin.

Adash dadauate shubu yacno choshon sedquid mene di dachinaid icshobic aidi mene ma dasiuidtequid nanu.

Adoshombic tsidadmeshun meneban, ma tsidadshun abi bunacpadembi dasiuidtequid nabedednu.

Adoshon bacuëmpibon naid isbanquimbi dasiuidquin tan ca. Ma tsidadash iccuededquin nanuc badedi dasiuidtequid icnuc tannu.

Tsiuec bëca icquidën sauan nibën A4.

Matsesëmpi nacenaid pisin sintsaid dasiuin. Adoshon mauete masiuintanquin tansetsëc matsesëmpibimbuec isadnuc.



Istanquin dadaua:

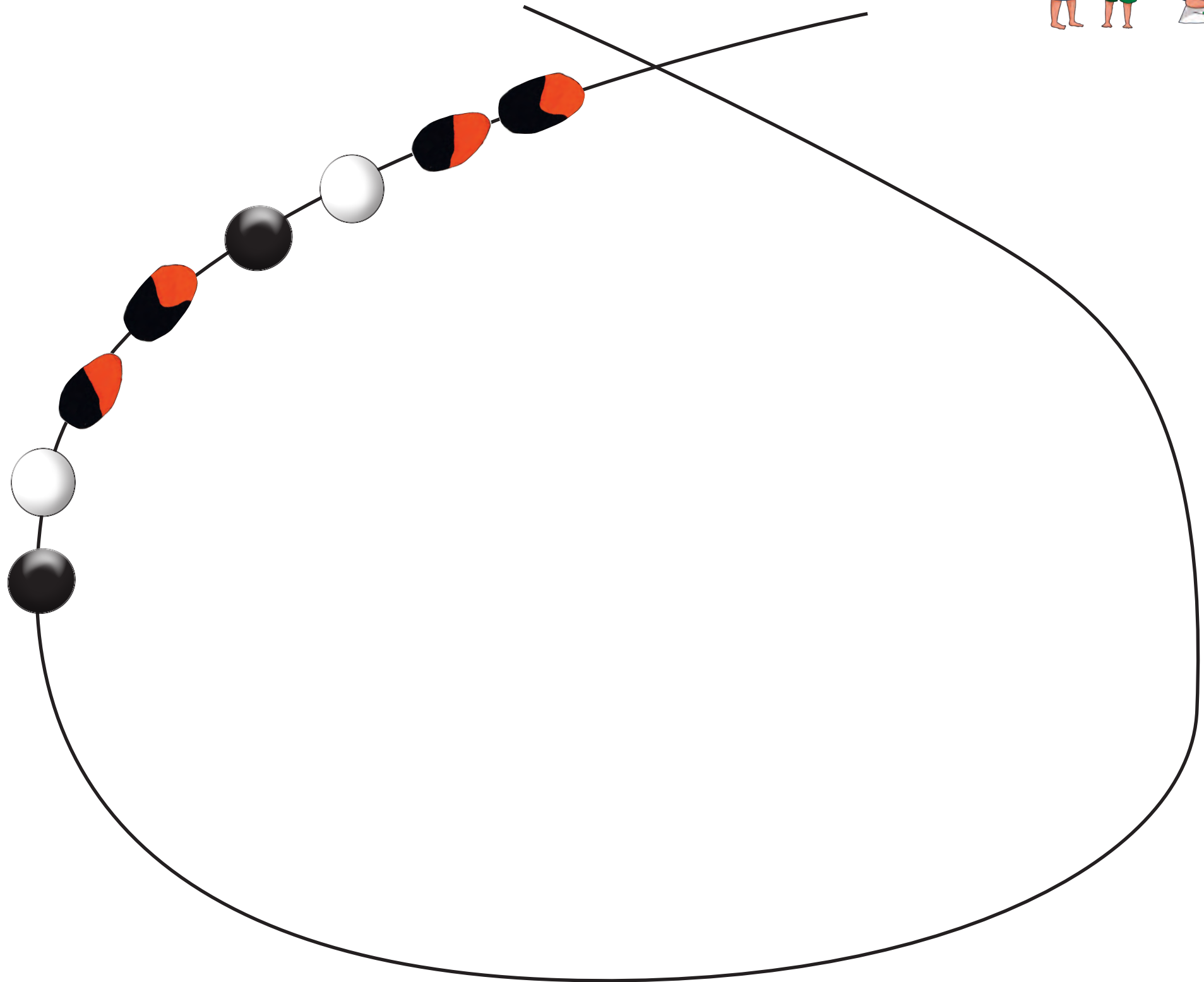

Min cuëmëdaid:

Payute nacnenaïd

Bacuëbo ismequid chido chiaïd:

Bacuëmbon tita ubi mocodibëta di bidicaïd bëshunta quequin chui. Adshumbic mocodi payutequid ancun.

Adoshombic tsidadmëban bacuëmpibouïdquïo, chidompibouïdquïo quenuc.

Adoshombic cute ëshëmpi menëban tedi-tëdïmbuen.

Adoshombic bëdambuen ancunme.

Bëyuc bedanquin tatau ëshë, aïd tsibanquimbic mocodi quequin ënapen icnuc buanquin. Payute tionquïo icnuc ënquin.

Adoshombi di bidicaïd champichëdo menëban ma abi mësiuidte ancumbannu. Aduac ancumbanec tatau ëshë, mocodi quequin bëdambo isadnuc.

Mësiuidte dënain.



Istanquin dadaua:



Min cuëmëdaid:

Midapadec piuten bëtiadtiad iccuededacno icnush

Bacuëbo ismequid chido chiaid:

Tsinac bacuëmpibouidquio champiuidquio quequin.

Adoshon papedote nuacquid nënantan nan, aid dadauatebëtabëbi.

Bacuëmpi abentsëc papedoten nanshun antan, aton dada abichobi buenacquin.

Adoshombic tsidadshun aton ëshë chedo nacnen aton dëbiate, ëcbid utsitedi.

Adembidi aton dada abichobi piuten tan-tanca tsidadash icnush piuten nocoshquete paden.

¿Midapadno tsidadash icacno icnush danoshquepec?

Adoshon bacuëbo bëisanmequin tabëc. Aden tabëctanquin mibëd bëisanec nidquid aton dada yacno mishbanquin aid nec quequin chuiban ca.

Bëtanteten sauan dadauashun mibi iccuededacnouësh piuten bëtiadte paden annoshca.



Istanquin dadaua:



Min cuëmëdaid:.....

Matsesën nëish cuesec iccuededquin penun

Bacuëbo ismequid chido chiaid:

Bacuëmpibo chui naden:

- ¿Tsundan papa nëish cuesquidquio iccosh?
- ¿Atoda pambid bëosh tsidadash iccuededacnoshon pebedednun?
- ¿Midapaden bëosh?
- ¿Tsuda pambid nuëmbo icquid menepec?
- ¿Tedta ushqin nëish cuesquidën pambid cuespatsiash?
- ¿Tsundan pete codocapec?

Bacuëbobëd mamëncueded naden chiad nabanec: Beyuc nid daëden tincaic.

Adash bidiaid shëcuë sadauc.

Adash udictsëc nid 5 teden tincaic dadauate shubun puduedacno cuësquec.

Adoshon papedote mene tsidadmeshun. Adoshombic dadauame podquied buanquin abi dadauate shubu yacno puduedec chobocpaden ma nabannu.

Podquied buanquin dadauaban nëish cuesquidën codocacno buantiadquio icac paden, midapadec nidquin buantiad iqueque.



Istanquin dadaua:



Min cuëmëdaid:

Chidobon sicaic iccuededacnoshon accuedednun

Bacuëbo ismequid chido chiaid:

Pachid buan dadauate shubu yacno.

Adoshon bacuëmpibo chui atoda napec pachidën tsidadash iccuededacnoshon nanun quequin:

- ¿Tedta pachid chicpatsiash sicaid natequid abitedi tsidadshun acte?
- ¿Tedta chidobonshon sicapatsiash?

Puduen bacuëmpibobëd umanuc.

Adoshon chui cacho daëd - cachodaëdquiec, casenanash tabad quequin.

Adoshon mibëtan daduaquidëmpibo dedobeded min cachonshon quequin.
Adoshon naden chui: ¿Tsuda ëuëmbo iquec?

Adash pudued dadauate shubun.

Adoshombic iuë tante chicshun utsi-utsien tanme. Adoshon midacquidën iuë udipactsëc iquec, midacquidën iuë tsidiontsëc iquec quequin chui. Adoshon midapad iuë tante iccosh tambanac quequintsen chui.

Tsiuec bëca icquidën sauan nibën A5.

Iuë tanten chiactedquio pachid samban.



Istanquin dadaua:

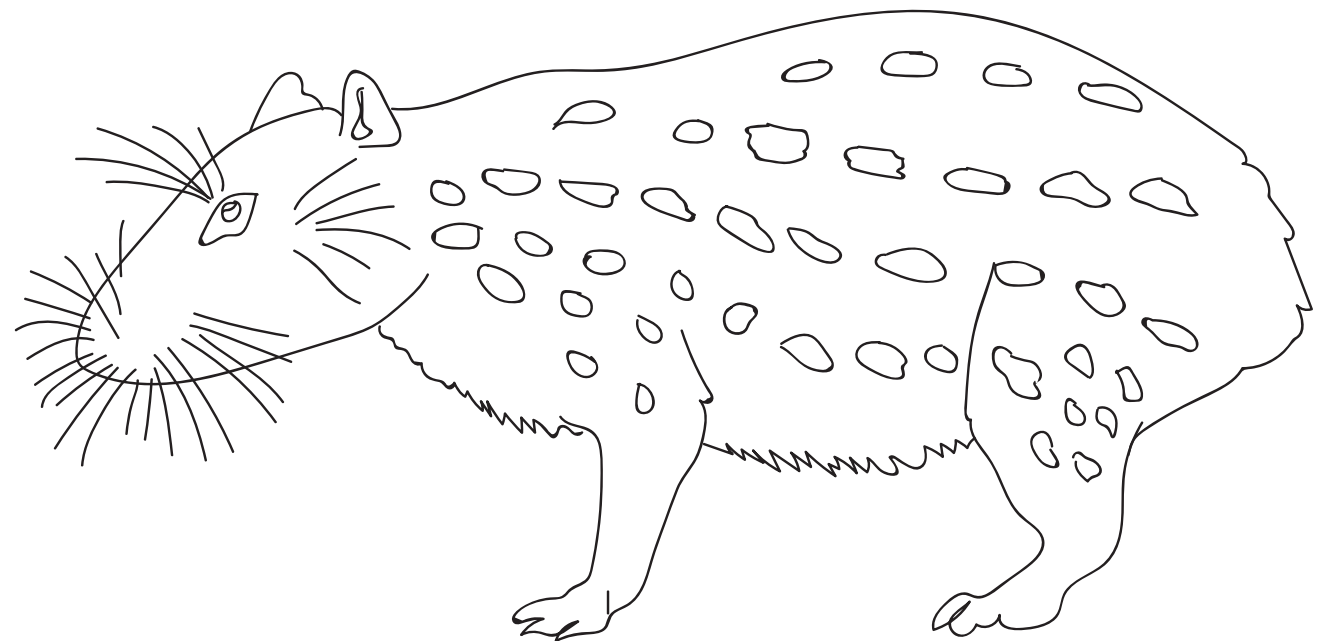
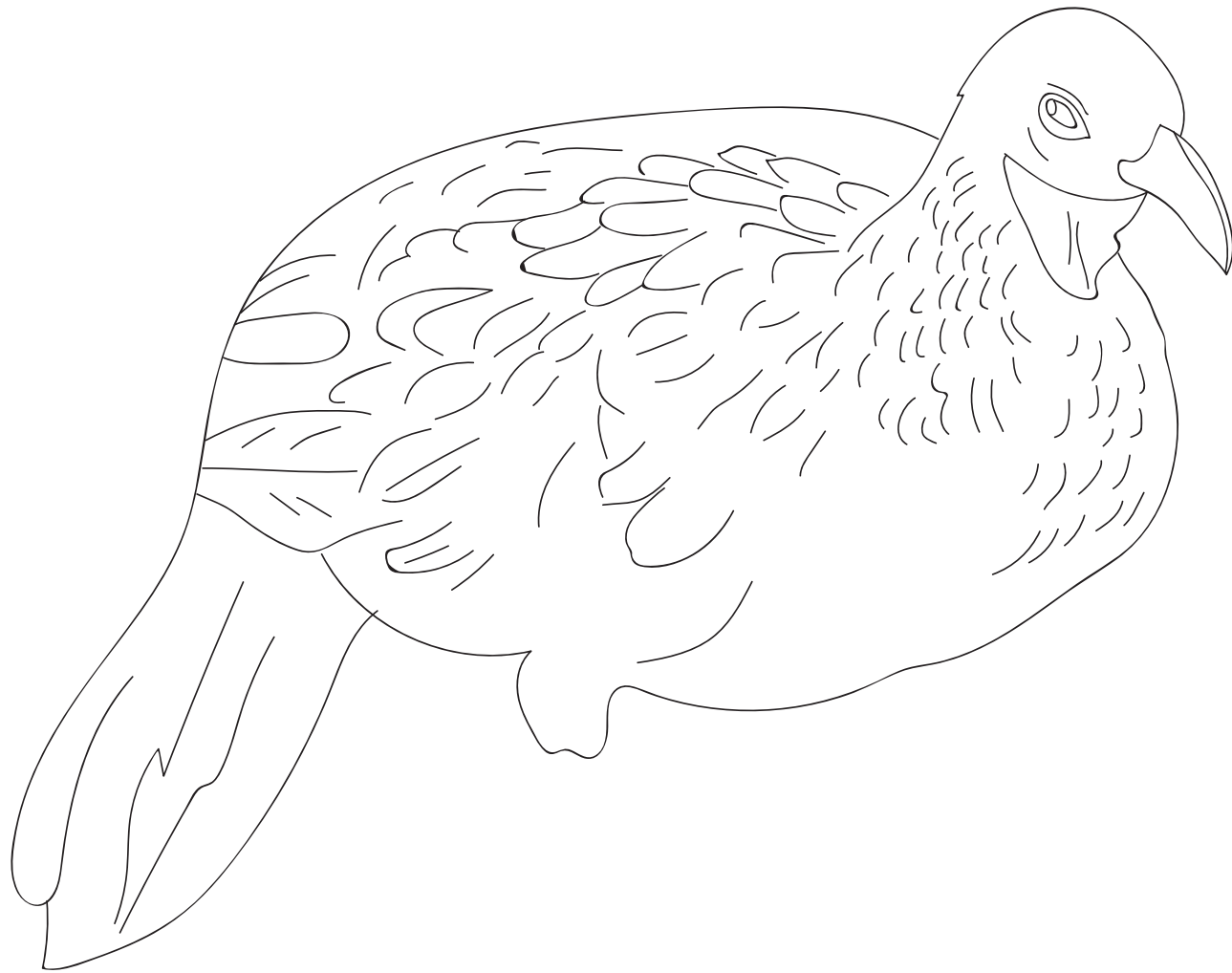

Min cuëmëdaid:

Nuquin buchido chedo bédambuen isnuna

Bacuëbo ismequid chido chiaid:

Bacuëmpibo chuiban aton buchido icquidobida neque.

Onquete bunquid icsho issun chuime. Aton cuëmëdaid, aton seta, aton buchidon naid chedo chiec.

- ¿Ada buchido nidpec, tsidadash matses iccuededacno?
- ¿Atoda pemepec?
- ¿Tsundan cuessumpec pambid chuca buchidon pete?
- ¿Midapadno pambid tëshshun buchido menepec ma penu qeshun?
- ¿Atoda acpec buchidon tsidadacnoshon?

Tambisën sauambëta cuëbun sauan dadauaid bacuëbo isme.

Adoshombic bacuëmpibo chui midapadquid aid nëish chedo neque.

Adoshombic chuime midapadno nuquin buchido menepec tsidadash tabadacnoshon ma penu qeshun quequin.

Daëd taë icquid anoshca. Adoshombic taë 4 ted icquid dënainquin dadaua.



Istanquin dadaua:



--	--	--	--	--



--	--	--	--	--

Min cuëmëdaid:

Mamënnuna mamënten

Bacuëbo ismequid chido chiaid:

Bacuëbobëd mamënnun mamënte nauedte daëd tabëc. Adoshon cute ëshë sandoshon tabëc.

Adoshon bacuëmpibo, chui naden nata quequin.

Mamënte nauedquin nauedquinqien cute ëshë abentsëc bedbanquinn dayunuaban quequin chui.

Adoshon daëd icnuc dëccuëscamianshun mamënte nemequid nauedme. Daëden nameban.

Aden naquin nainmetanquin mibi nauedquin bedbambued cute ëshë sanambeded tedta mimbi nauedaque isnu quequin chuiquimbi nadentsen chui:

- ¿Tsundan abentsëqui nauedosh?
- ¿Tsunda dëd nauedosh?
- ¿Tsundan nauedambo iccosh?

Adoshon padidembuen cute ëshë sandotanquin padpiden bedbanec mamëncueded quequin chui.

Bacuëmpibon nauedbued tantiaquin ambi nauedboctedquio tambanquin tëshquënëmpi annoshcameban.



Istanquin dadava:

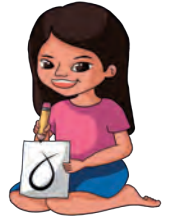

Min cuëmëdaid:

Anquiadacsho iste

Bacuëbo ismequid chido chiaid:

Tiquidiuaquin bacuëbo tabëc. Adec tabadquin dadauamequidën chuibanec bacuëbo abi anquiadaid. Ma bëdamboen tantianu qeshun bacuëbo ismequidën naden chuibanec:

- ¿Midacquidtedi nuqui isedpo?
- ¿Tsuda chedo nuqui isedpo? ¿Adembidi tsuda chedon nuqui isedposh?
- ¿Atoda nuqui ismeposh?
- ¿Atoda nuqui tantiacmaid anquiadpo?

Aden tantiaquin bacuëmpibo ismequidën menebanec. Bacuëmpibon ambi nabante utsi-utsien ma sauan nanu qeshun. Adembidi ma annoshcanu qeshun. Adecbidi abi ushë abentsëquën anquiadaid tantiec ma utsi-utsien chiec onquenu qeshun.



Istanquin dadaua:





Chetequid cuësaid

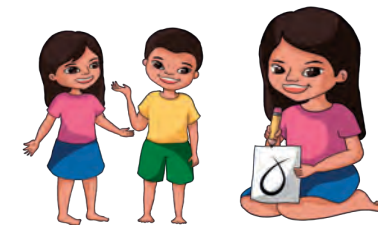

Min cuëmëdaid:

Cana bata pequid nec

Bacuëbo ismequid chido chiaid:

Chetequid utsi-utsien buan dadauate shubu yacno.

Bacuëbo chuime chetequid cuëmëdaid, atoda uicchun aid chetequid bumpec.

Bata meneban bacuëmpibo abitedi champichedobëtabi dadauate shubu yacnoshon.

Chuiban:

- ¿Midapad chiadec?
- ¿Atoda quiash cana aid bunquiopec?
- ¿Midapad bata sinash isadpec?



- ¿Tsuntsin min shubun icquidën bata cuësquin tantiapec?
- ¿Tsutsi bata mëtete bumpec bata sinacsho isash?
- ¿Dadpenquioda bata icpec, daëdpactsëcta icpec?

Sauan icquid midambo utsiecbidi iqueque istuidshun bëtiquidiua. Adembidi samëdadquidtsen.

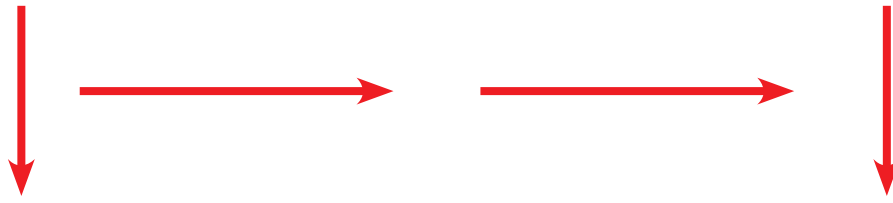

Istanquin dadaua:



Min cuëmëdaid:.....

Podquied istuidnuna bata cuësec nidnun

Bacuëbo ismequid chido chiaid:

Dadpen pia nacnen madin shubu teteshun.

Adshumbic nidaidëmbi shubu dayun
podquiedëmpi naban.

Bacuëmpibo chui mitsipad podquied iquec min
shubu yacnoësh dadauate shubu yacno nidec.

Chuisho tantiash mamënte yacno nidanne.
Ashunquio chui ma bédambuec nidannenu,
aton shubu yacno nidec, dadauate shubu
yacno chobocpadquiec ma nidannenu.

Bacuëmpibo abitedi chomeshun chui, madin
shubu daëd tsadunshun nëmbo min shubu
tsadec, nëmbobic min dadauate shubu
quequin.

Adshun isme cuestempin
podquiedbimbuecnuc simban min shubu
yacnoshon bedanquin dadauate shubu yacno
cuëscaquin.

Dadauate shubu yacnoshon chuime,

- ¿Mitsipad podqued iccosh?
- ¿Ada utsiec isadosh podquied daëd
icquid quequin?

Chome ma abitedishun aton podquied aton
shubu yacnoësh nidacbimbuecnuc simbannu
aton dadauate shubu yacno buanquin.

Adoshon dectanme shubumpi aton nidaid
cuësquiacnobimbuecnuc nashun.

Adembidi dadauate shubu
cuësquiacnobimbuecnuc nashun mene madin
shubu piabimbuecnuc tetiaid bacuëmpibo ma
aidën podquied aton dadauate shubu yacno
nidacbimbuecnuc nanu.

Bacuëmpibo chui.

Podquied bata cuësec nidaid umboda iquec.
Min shubu yacnouësh dadauate shubu yacno
chued podquiedbëta isac.

Matsesëmpi podquiedën buan, aton shubu yacno yacnombo nidquin piampin mëdmebanquin.



Istanquin dadaua:



Min cuëmëdaid:.....

Mëcuesten bata pec

Bacuëbo ismequid chido chiaid:

Nidaidën papedote nuacquid dectan.

Nidaid cacush acten “baddempin” cushtoquin.
Actebëta tempeda cabiun ma utsi-utsiec
isadnu.

Bacuëbo tsinac daëd icnuc.

Adshun chui, ma aton taë chucuuvaquin
badde antincanu nidaidbëta acte cacushshun
nitsinaid.

Adshumbic mishmequin. Adshumbic
papedotentsen capumequin.

Aden capumeshun ambi tincaid ismequin.

Chuime:

- ¿Atotsi papedoten iccosh?
- ¿Mitsipad papedoten tincaid iccosh?
- ¿Atondan tincaid nec?
- ¿Mitsimbo tincaid istuidtiad?
- ¿Atotsi nuqui nape chetequid
dadpenquio icnuc?
- ¿Tsundan chepec aid?
- ¿Midapaden nëish aid nec quequin
tantiapec?

Chuiban mimbi nëishën taën tincaid isaidtedi.

Tsiuec bëca icquidën savan nibën T4.

Nëishën taëc ictsëcquido bédambuen issun, midambo icquid neque abi yacnombo bitaccaban.



Istanquin dadava:

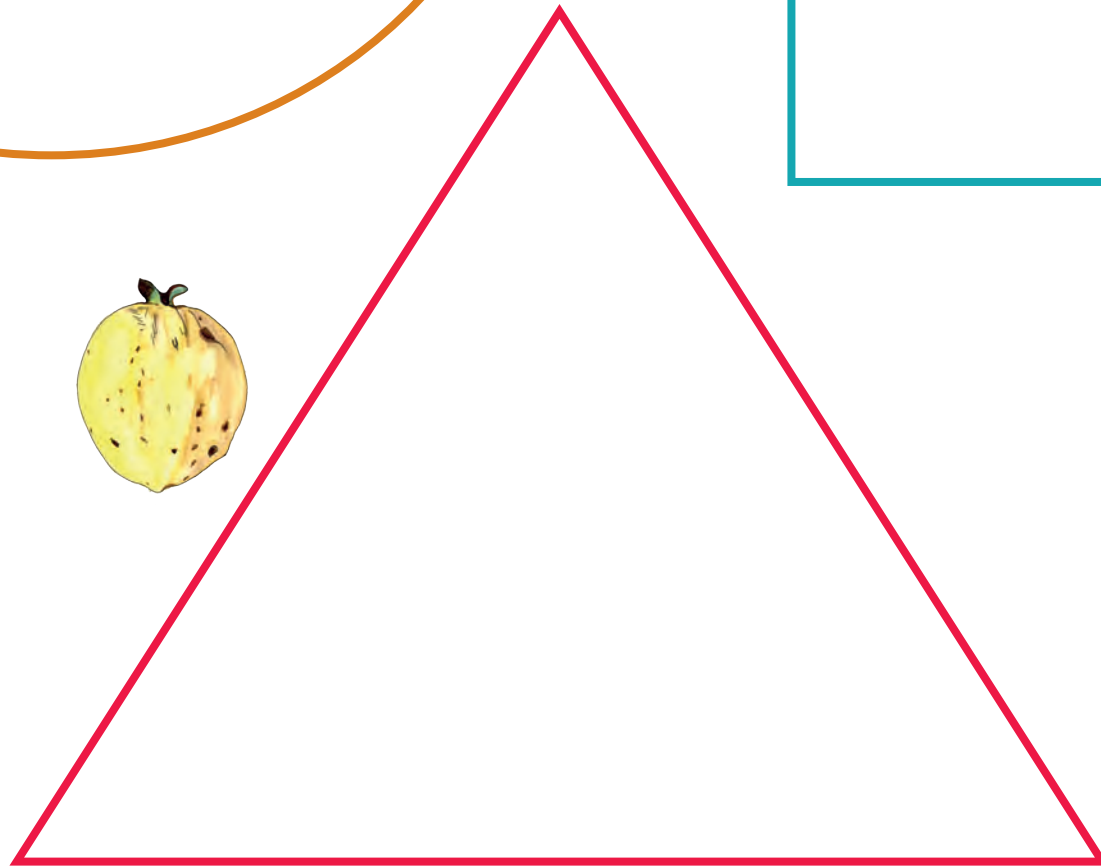
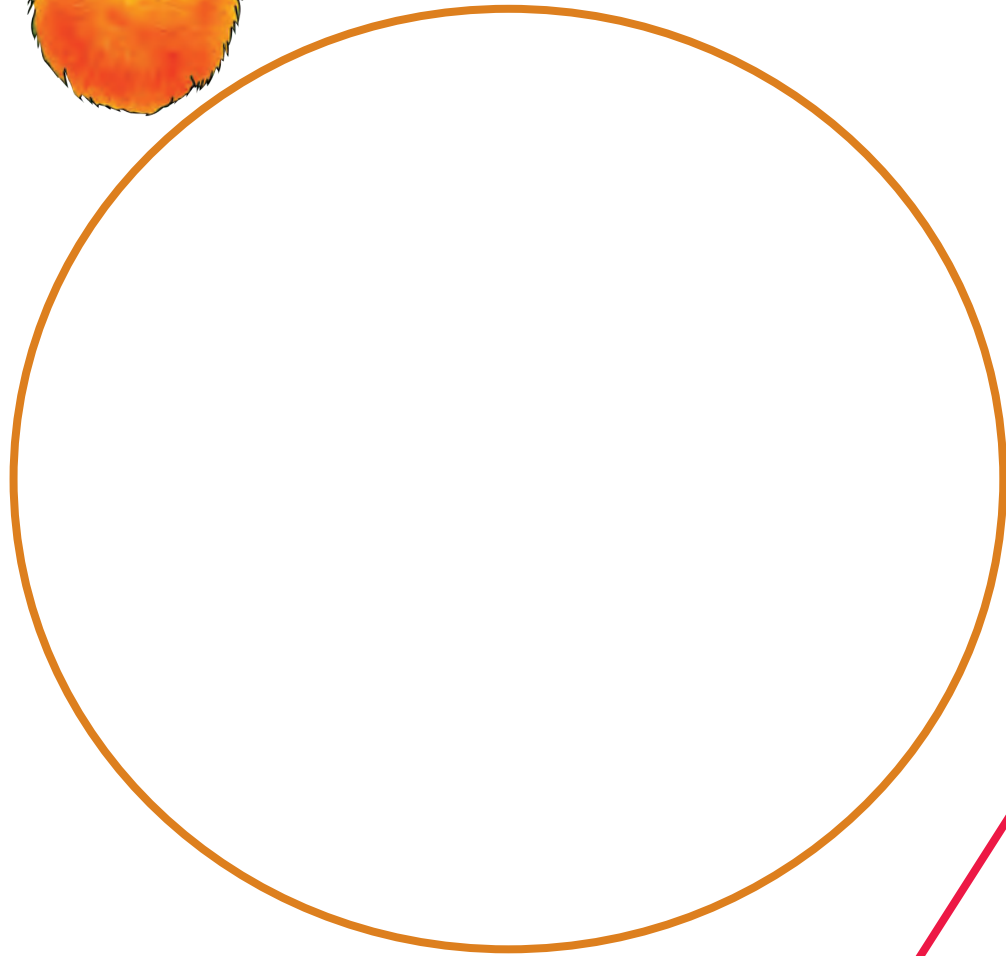

Min cuëmëdaid:.....

Chetequid utsi-utsien cuësnuna

Bacuëbo ismequid chido chiaid:

Dadauate shubu yacno nëidted chete bëec:
mamuin, chështe, bata, caimito, moste.

Adshumbic mibi yacnocquid cute utsitedi.

Chuiban bacuëbobëta champibo:

- ¿Midapad isadquid nec?
- ¿Midambo cuëstiad?
- Bacuëbo chochomequin chemequin tanmebannun.

Chui ma tsinacnu utsiaquin sanquin: Utsi-
utsiec isadquid, abiuidquio tamëdquid, abi
tenquiocquiduidquio.

Tsiuec bëca icquidën sauan nibën A5.

Bato daëdpactsëc bitacca, caimitobic dadpenquio, mamuin nibëdec.



Istanquin dadaua:

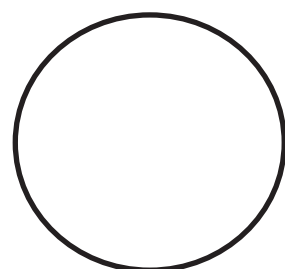
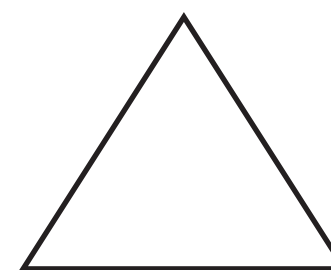
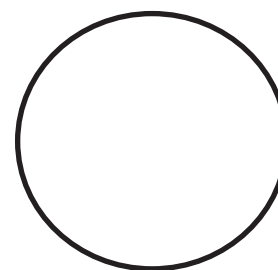
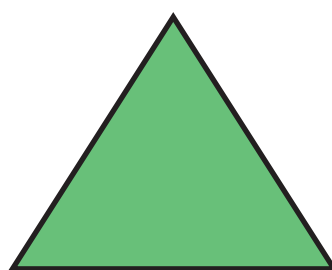
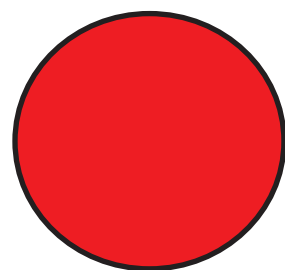
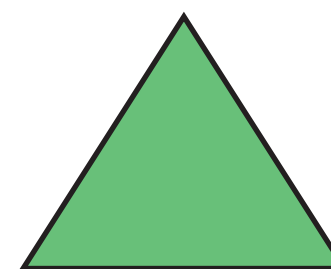
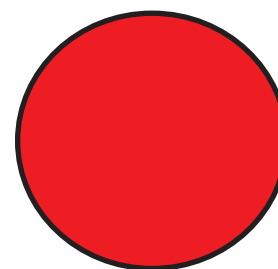
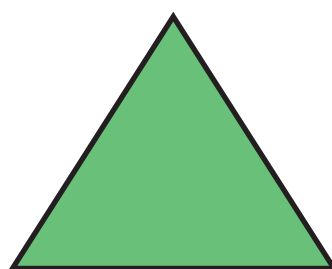
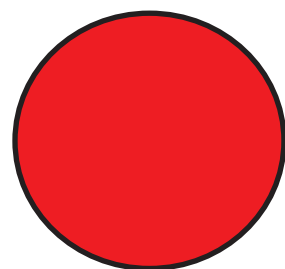

Min cuëmëdaid:

Bata cuëstequid tedi

Bacuëbo ismequid chido chiaid:

Bata cuësquin nate tedi buan dadauate shudu yacno: (chështe, nëshaid, chodompi quequin).

Chui:

- ¿Atoda nate nëido nec?
- ¿Atoda chedo itia bedec nidquin buampec?
- ¿Bacuëbo isme bata cuësquin nate tedi?

Adshun nacnen aidobëtambi chështe cuembo dectanquin, nëshaid, chodompi, quenuc.

Ma ubi udictsëc nate bunnuc atoda chodo tsibanec icpatsiash. ¿chështe, nëshaid, chodo?

Shubu dëchimbiec utsi-utsiectsëcquido bacuëbo meneban. Adoshombic chështe padquid nec quequin tiquidicquid bed, nëshaid padquidic podquënacniaid, chodo padquidic shubu dëchimbiecquid.



Utsi-utsiec isadquid bedmetanquin tsiban-tsibanquiec samëdnidnuc nameban.

Sauan dadauatanquin midacquid udictsëc iqueque annoshca.

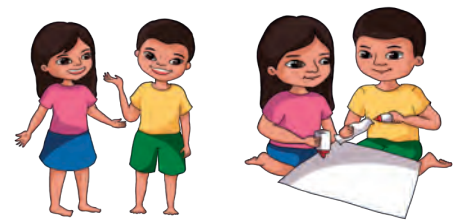
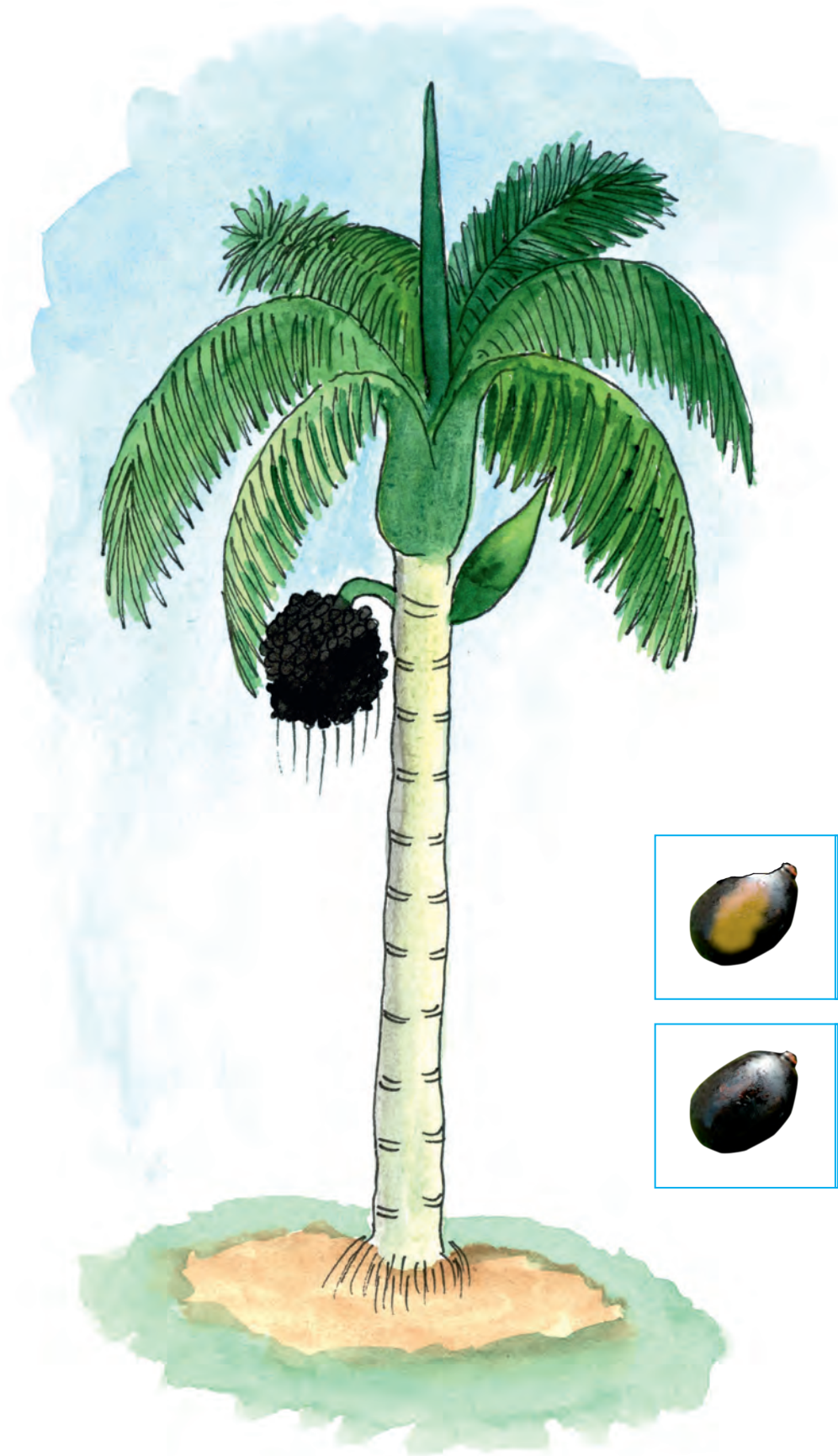

Istanquin dadaua:



Min cuëmëdaid:.....

Isanën nabannuna

Bacuëbo ismequid chido chiaid:

Onquecueded titachedoböd ma mibi isan musuc menenu.

Daduate shubu nuntan tiquidiec tabadquin isan isban, mishquin, shödquin midapad iqueque.

Bacuëmpibo chochomeshun tsidadme daöd icnuc.

Tsidadaid 1 isan uisaido, tsidadaid 2 isan shubo.

Mamëquin bedan utsi-utsien naic, naden caimbi:

Isan uisaido dayunnanec, isan shubobic mëdimnanec, isan uisaido tebdidi shëcquecuededec, isan shubo tebdidi pudundotanec.

Isan chodquiaido quenuc utsi yacno manniadcuededec.

Mamëncueded quequin bacuëbo chui: sedunte bëchudanten 4, 7, 10 ted cuëscaqquin icsambocquid.

Tsiuec bëca icquidën sauan nibën A5.

Bitacca 5 ted isan uisaid 8 ted Isan pisenaidbëta abi yacnombo istanquin. Tëshquënën icquid icactedquio annoshcaban.



Istanquin dadaua:



Min cuëmëdaid:.....

Itia uisacsho tantiaben chuuashun chenun

Bacuëbo ismequid chido chiaid:

Chomequin aton tita abetsëc itia uisacsho ismenuen.

Daduate shubu yacno tita chomeshun, bacuëbo chuiban midapaden isan uisac quequin tantiapec.

Aton tita oncamequin chuime bacuëmpibo bunsho issun midapaden itia badedquio chuuapec quequin.

Bacuëbo isme tenda acte cacushpec, acte chupenquio icnuc. Adshun cainec ma chodquenu qeshun.

Chui bacuëmpibo ada itia chequin tantieque.

- ¿Midapad itia icquid chete bune?
- ¿Ada itia sinuaquin tantie?

Nuqui chedo itia chuuquin ismec chobued nuquinta bëdambo iquec canuna, nuqui ismianec nidsho.

Tsiuec bëca icquidën sauan nibën T4.

Sinambo yacnouësh bedanec itia sinacno cuëscaquin dadaua. Adoshon mimbi tantiacpadembi dadaua.



Istanquin dadaua:

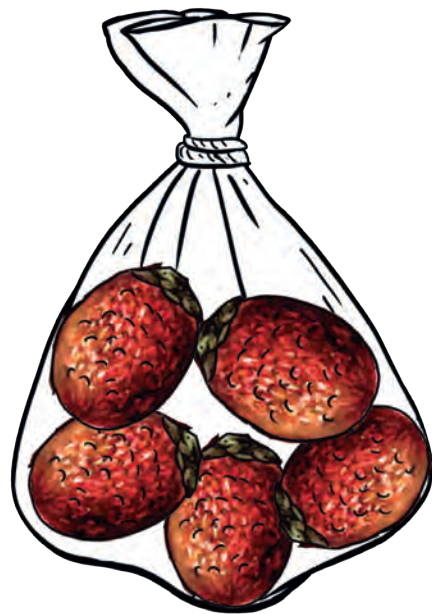

Min cuëmëdaid:

Itia bedshun bendeuanuna

Bacuëbo ismequid chido chiaid:

Buan itia uisaid icsactsëcquidëmpibëta dadauate shubu yacnoshon ismenun bacuëmpibobëtan champichedon ma isbedednu.

Chuiban itia dëdaid chuiquin utsi-utsiec itia icaid midacquid chetequid nec. Utsi piucquid bedquin menete nec. Chui utsiuaquin bëdambo uisaid san icsactsëcquidic utsiuaquin quequin.

Chuiban:

- ¿Ada itia utsiec isadquid isonda?

- ¿Atoda quiash utsi-utsiec isadpec?
- ¿Midapadquid itia piucquid bedquin menepec?
- ¿Mitsipaden itia piucquid bedquin menepec?
- ¿Tedtsi piucquid icpec?
- ¿Tedta piucquid nuqui bumpe itia bednun?

Itia menenanshun chebedednuna.

Champibëtan bacuëmpin itia bedquin piucquid menete tedquio un sod icquid annoshcaban.



Istanquin dadaua:



Min cuëmëdaid:.....

Anquiadacsho iste

Bacuëbo ismequid chido chiaid:

Tiquiduaquin bacuëbo tabëc. Adec tabadquin dadauamequidën chuibanec bacuëbo abi anquiadaid. Ma bëdamboen tantianu qeshun bacuëbo ismequidën naden chuibanec:

- ¿Midacquidtedi nuqui isedpo?
- ¿Tsuda chedo nuqui isedpo? ¿Adembidi tsuda chedon nuqui isedposh?
- ¿Atoda nuqui ismeposh?
- ¿Atoda nuqui tantiacmaid anquiadpo?

Aden tantiaquin bacuëmpibo ismequidën menebanec. Bacuëmpibon ambi nabante utsi-utsien ma sauan nanu qeshun. Adembidi ma annoshcanu qeshun. Adecbidi abi ushë abentsëquën anquiadaid tantiec ma utsi-utsien chiec onquenu qeshun.



Istanquin dadaua:





Nëish bedaid

Bata shubuuaid



Dunu aton utsibëd nidquimbi
bata shubu uashun  sequin
cainnëdaid  istuidosh.

Aden istuidshun  Dunún
shubunaush.

 Adoshon cainquin shonquid
dadpen siosh.

Nëish icnëdaid chiaid

Bacuëbo ismequid chido chiaid:

Bacuëmpibo chome chuibanquin tantiamenun.

Adshun chuiban bédambuen, tiquidiuatsëcquin cuenadmetsëcquin tabëcshun ma tantiec tabadnu.

Adshun bëdiactsëc bedantsëcquin chui, tambanquiotsëcquin ma bacuëmpibon bunquioquin tantianu.

Dunu aton papa, aton buchi chedobëd shonquid senu quec nidanniosh.

Adec nidquin bata shubuuashun shonquid sequin cainnëdaid shubu shënimpi istuidosh.

Aden istuidshun bata natiacquin shonquidën chiacsho issun chucauaquin shubu naush Dunun aton papa chedobëtan.

Adoshon cainquin shonquid dadpen siosh.

Aden sianec cuishonquequiec chosh aton shubuno.

Dunun aton tita chiosh ambi shonquid senun shubu uaquin tatiabembued midacquido matses shonquid shubuuacno iccoshe chuiban shonquid sebued chedobi chiec onquecueded.

Adshun ënden chuinënaid isbannuna quequin chui. Adoshon ambi natequid dadauate meneban.

Ënden chuibanaid isquin chuibanshun aidën chuibanaidën icquid matses chedo chuibanaidën cuëmëdaid dadaua.



Istanquin dadaua:

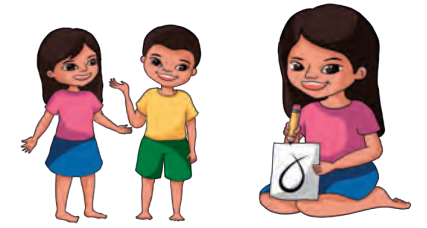

Min cuëmëdaid:

Podo choquid matsesën cuesaid

Bacuëbo ismequid chido chiaid:

Bacuëmpibo chui ma aton papan o aton buchidon podo choquid cuesaidën sauan dadauanu.

Adoshombic nidaidën dectan mimbi sauan dadauaid.

Adoshon tsinac abiuidquio isadquid.

Adshun chuiban midacquidquio podo choquid cuesaidquio icpec.

- ¿Midacquid podo choquid daëdquiobi cuesaid icpec?

Adoshon ambi nabantequid dadauate meneban. Ambi tantienquio icaid icsho nashumban.

Bëdambuen sauan istanquin utsiecbidicquid istuitanquin bëtiquidiua.



Istanquin dadaua:

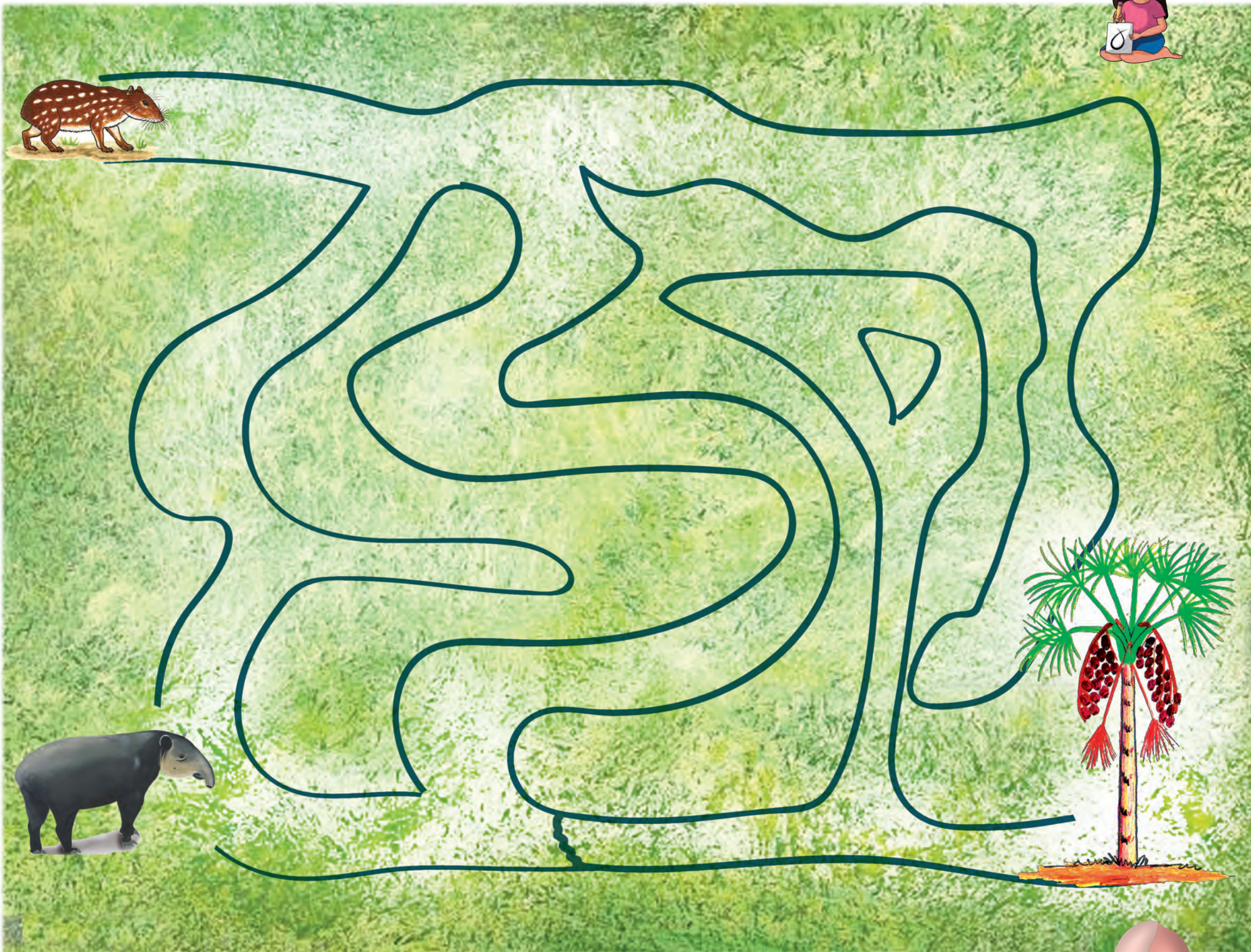

Min cuëmëdaid:

Mitsimbo capupec nëish abitedi aton pete istuidnuec

Bacuëbo ismequid chido chiaid:

Bacuëmpibo umanuc buan mamëncuedednun.

Bacuëmpibo daëd icnuc tsinac tsidadaid cuëmëdec “nëishamë” utsi tsidadaidic “tambis” quequin.

Madin shubu tsadun daëd. Madin shubun nëishamën sauan dadauaid annan, utsimbi tambisën sauan dadauaid.

Adshun itia abi maisi samban. Adotanquin mamënquin bedanme 1, 2, 3 puduan!!

Aduac mënchiquidenquio cadinnanacchobi niqianquin ambi itia uanno-uanoen sambued bëyucquidën bedbanshun aton madin shubu tsadunaidën sandobanec. Adshun tambanec tsidadaid nëishamën tedta bedac, ma tambisën quequin.

Adoshon chuiban naden:

- ¿Midambo icquido nëish nepec?
- ¿Atotsi aton pete icpec?
- ¿Atoda nuqui istuidpo nidaidën samëdquid itia pequid?

Adec mamë nec ënëdshun bacuëmpibo buan mëpamëdmenun, choshon ambi nacbocpadquid dadauabannun.

Nëishamën tincaidbëta tambisën tincaid sauan dadaua abi itia pec nidaid.



Istanquin dadaua:

*Cun taë iquec
Cun podo iquec
cun iquec
¿Tsutsibi ne?*

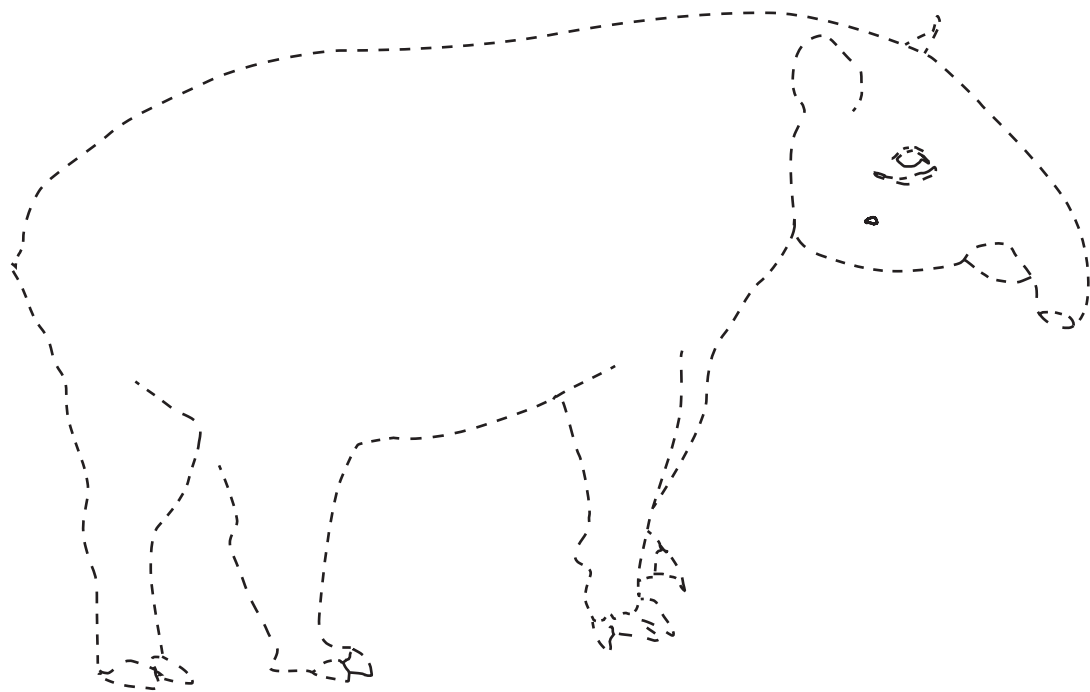

*Badiadën usquid
nebi inchëshën
capuquid nebi.
¿Tsutsibi ne?*



Atoda nëish neque chui

Bacuëbo ismequid chido chiaid:

Ompoquin chiaid daëd dadauatanquin pisanan dectan.

Adoshombic nëishamën sauambëta tambisën sauan nashun pisanan dectan. Dectanshun paped utsin bëpuc bacuëbon badedi isnushe.

Adoshon bacuëmpibobëtan bëdiactsëc isban.

“Cun taë daëd iquec,
cun mëdante daëd iquec,
cun mapi abentsëc iquec,
cun cacho chëshëmbo iquec”.

¿Atodaibi ne?

Badiadën ushebi, inchëshën pëmbi,
itia bunquidquio nebi..

¿Tsudaibi ne?

Padpiden anisquin chuitanquin bacuëmpibo naden chui:

- ¿Atoda nëish nec?
- ¿Tsundan ompoquin chiaid chuipec?

Ambi nabantequid dauate mënëban. Adoshon abëtambi naban.

Mimbi dadauaid ompoquin chiaid isbanquin chuiban. Adoshon ompoquin chiaid yacnombo nëishën sauan bitaccaban.



Istanquin dadaua:



Min cuëmëdaid:

Uicchunën shubu bédambuen isnuna

Bacuëbo ismequid chido chiaid:

Bacuëmpibobëd umanuc puduenshun mimbi cuëdsho tantiaid tedi chuiban quequin chui.

Nibënquin cuicchunën shubu istuidtanquin naden chuiban:

- ¿Tsundan aid shubu napash?
- ¿Atoda uicchunën ani nec?
- ¿Atoda nuqui istuidpo uicchunën shubu ëquëduc?
- ¿Atoda quepatsiash nuqui mishac?
- ¿Midapaden aido dayunuatiad?

Aucbidi dadauate shubu yacno chuash uicchunën shubun mamënnuna.

Bacuëmpibo mëdinnanme . Adoshon abëd icquid utsimpibo mëdinnanaid nënantan puduedme uicchunëmpi aton shubun puduedacimbuec.

Ambi nabantequid dadauate menebanshun abëtambi naban.

Sauan dadaua tedtsi oshpodcon tishoshe, ma 5 ted uicchunëmpi aton shubun icnuc daëd icsapaboc.



Istanquin dadaua:

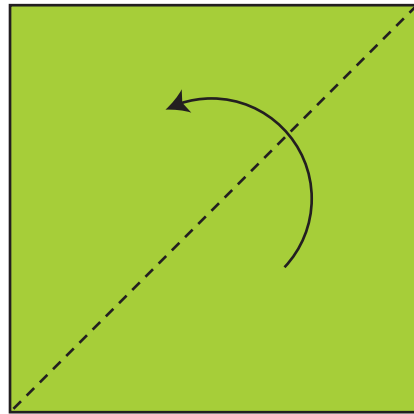
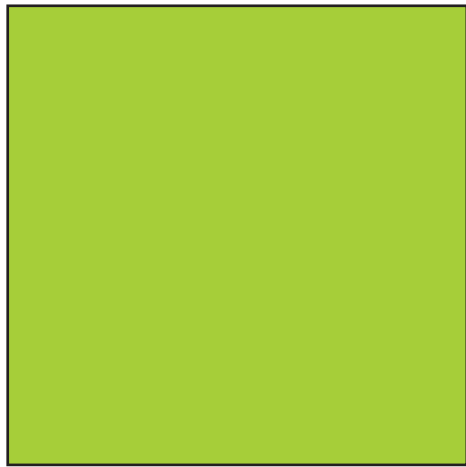

1

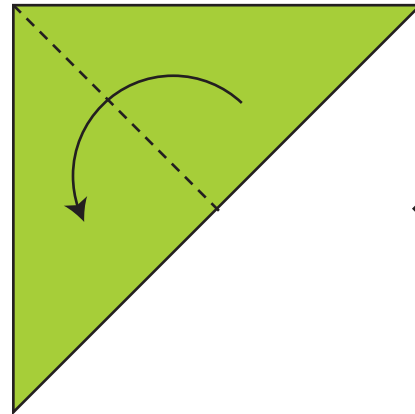

2

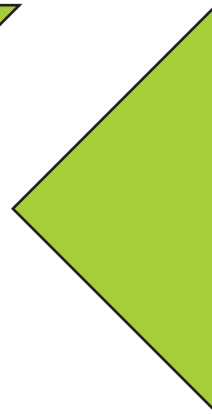

3

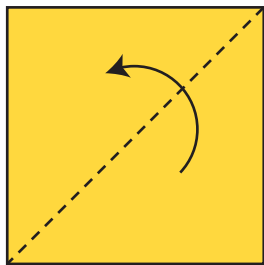
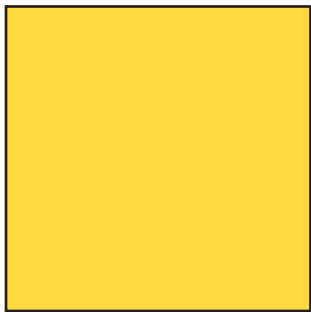

4

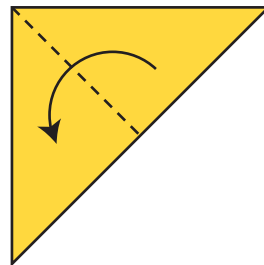

5

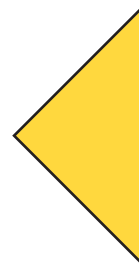

6

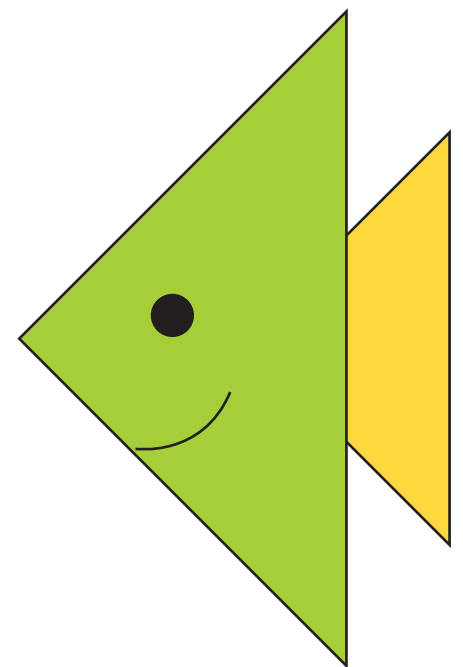

Min cuëmëdaid:





Min cuëmëdaid:

Papedën uicchunëmpi nacnennuna

Bacuëbo ismequid chido chiaid:

Bacuëmpibo ambi uicchun isnëdaid chuiban.

Adoshon min dadauatedapan icquid abentsëc bëca umucquid chedo icquid mibi bunaidi tështaanquin chuibanac paden naban ca.

1. Abentsëc tëshquëmbimbuecnuc naquin.
2. Bëtashquin podquënacquin.
3. Uicchunën podobimbuecnuc podquënactsëcquin.
4. Uicchunën ëshëbëta dëbiate natsëcquin.

Ambi nabantequid paped meneshun uicchun naquin nashumban cutempi tabadnuc sauan dadauacno bitaccanun.

Mimbi nabued podo choquido cute tabadnuc sauan dadauaid yacno bitacca.



Istanquin dadaua:

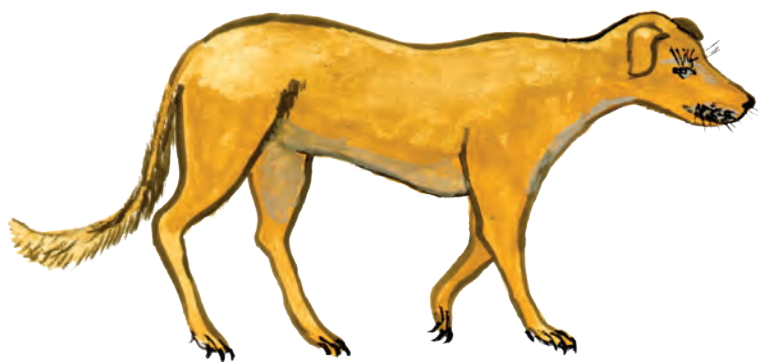
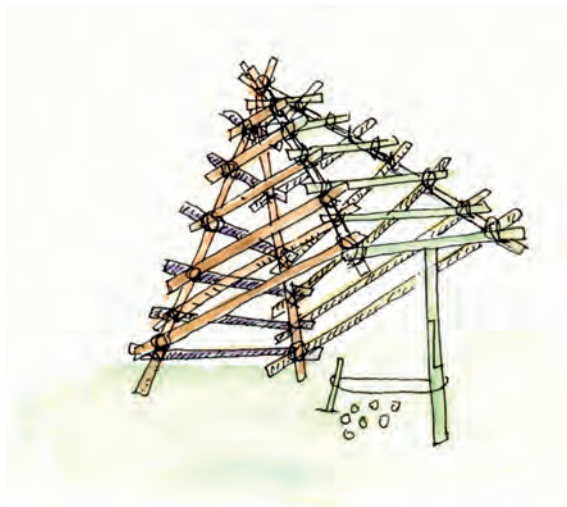

Min cuëmëdaid:

Opan nëish bedaid

Bacuëbo ismequid chido chiaid:

Opan sauan icquid bacuëbo isme.

Adoshon bacuëmpibo chui midapaden opan nëish bedquin nuqui nashumpec quequin.

Adoshombic opa dëchinquin tantiaquid yacno nidshun tantiabeded. Midapaden opa nëish bedquidquio icmenuen napec quequin. Ma ënenquio icquin nedquidquio icnu qeshun atoda napec quequin chedo chuiquin.

Adembidi nuqui chiec:

- ¿Atoda nëish opan nedpec?

Adoshon ambi nabantequid dadauate mene.

Abimbo yacno semequin simban midacquid nëish opan nedaid neque.



Istanquin dadaua:

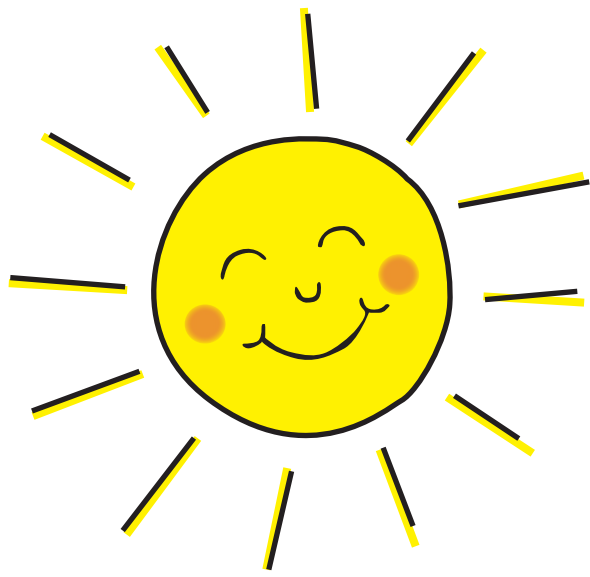

Min cuëmëdaid:.....

Badiadën nëish bedaidbëd inchëshën nëish bedaid

Bacuëbo ismequid chido chiaid:

Nëishëmpibo utsi-utsien nacnenaid nidaidën sambud: shëcten, senad, shonquid, bëchun, omon, dide, tambisëmpi chedo.

Adoshon bacuëmpibo, chui nëish badiadën capuquidbëta inchëshën sanac quequin.

Umanuc puduenash bacuëbobëd mamën.

Aduac bacuëbon ubi nëid nëish icte bunebi quequin chuibanec.

Adoshombic ushëtsen ismequin chuiban badiadën icquidta nec, inchëshën icquidta nec, quequin chuimeban.

Adoshon nëish inchëshën icquid istuidmeban.

Adoshombic mamënmequin ënshun abitedi puded-puduedme dadauate shubu ëquëduc.

Adoshon chuiban atoda quiash nëishamë inchëshën capuequi, badiadën ushpec. Adecbidi shëctentsen badiadën capuec, inchëshën ushec quec onquequin chuiban.

Ambi nabantequid dadauate meneban.

Tsiuec bëca icquidën sauan nibën T5.

Bitaccaban midacquid nëish badiadën neque capuquid, midacquid inchëshën capuquid neque abimbo yacno istanquin.



Istanquin dadaua:



Min cuëmëdaid: _____

Anquiadacsho iste

Bacuëbo ismequid chido chiaid:

Tiquidiuaquin bacuëbo tabëc. Adec tabadquin dadauamequidën chuibanec bacuëbo abi anquiadaid. Ma bëdamboen tantianu qeshun bacuëbo ismequidën naden chuibanec:

- ¿Midacquidtedi nuqui isedpo?
- ¿Tsuda chedo nuqui isedpo? ¿Adembidi tsuda chedon nuqui isedposh?
- ¿Atoda nuqui ismeposh?
- ¿Atoda nuqui tantiacmaid anquiadpo?

Aden tantiaquin bacuëmpibo ismequidën menebanec. Bacuëmpibon ambi nabante utsi-utsien ma sauan nanu qeshun. Adembidi ma annoshcanu qeshun. Adecbidi abi ushë abentsëquën anquiadaid tantiec ma utsi-utsien chiec onquenu qeshun.



Istanquin dadaua:





**¿Midapaden neste bedquin
tantiabentiad?**



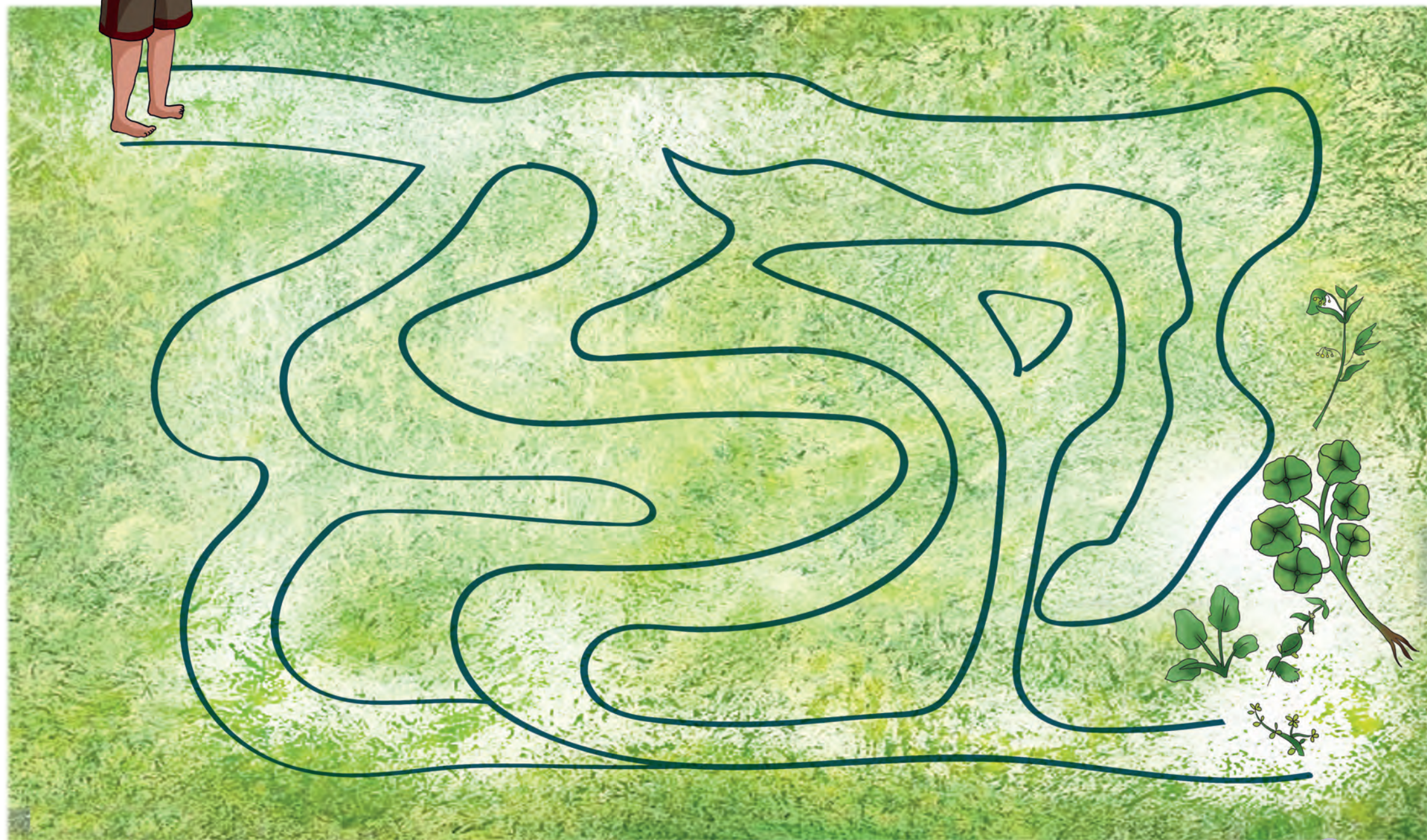

Min cuëmëdaid:.....

Midambo neste icpec, nuqui bēdanmequid

Bacuēbo ismequid chido chiaid:

Nesten sauan dadauame uanno icquid:
(Chishpan dauē, usudquid dauē, pucu dauē,
dannēsh dauē, quequin).

Bacuēmpibo chui:

- ¿Midacquid bacuēmpi min dayun iquec?

Adoshon bacuēmpi mēdinshun, aton
cuēmēdquid chui.

Midacquid champi o dadampi tsadte utsin
iquec.

- ¿Ada mēdintsia?
- ¿Mibibi nitoash nid aid icacno?
- Adshun naden chui: ¿Midambo nēbi
papa icpec?
- ¿Ma tita?
- Mibi ēcbedsho tantiatanquin naden chui:
¿Uannomboda icpec o nēbictsēqui?

Neste uanno icquidēn sauan naid ismequin
naden chui:

- ¿Midambo icquid nēid neste chedo
nepec?
- ¿Atoda bēdanmepec aidēn?
- ¿Aden bēdanmequin tantiaquid uannoda
icpec o dadauate shubu dayuntsēqui?
- ¿Tionda neste bedquin tantiaquid
nidpec?

Aden chuibanaid ēcbedbansho tantiatanquin
ambi nabantequid dadauate menebanshun
abētambi nashumban.

**Bacuēmpi neste ēnapen yacno nidmequin nashuntanquin, aidēn dayun shubu tsadnuc
sauan dadaua.**



Istanquin dadaua:



Min cuëmëdaid:.....

Cute bëpin chiuë dauën nuqui bëdanmec

Bacuëbo ismequid chido chiaid:

Bacuëmpibo chui ënden chuinëdaid daëdpactsëc.

Timoteobëd Dina Iquitos yacno icquid nec. Aido mamënten mamënte bunquidombo nec.

Adecbidi Benito Uasabëd actiamë yacno icquido nec. Aido adecbidi mamënte bunquidombo nec. Adecbidi mamënte bunquidquio nec.

Adquido iquec mamënten mamënec uebudec dambiucudosh.

Adacsho aton titan Benito chotaquën chiuë dauën ambiunshunosh.

Aden aidën nanubi Uasan titan chiuë dauë cute bëpinën ambiunosh.

Adotanquin bacuëmpibo chuiban naden:

- ¿Tsuda ënden chiadën icacpadece dambiucudondash?
- ¿Atoda quiash dambiucudaidënuësh intac chopec?
- ¿Midapaden aid bëdanmepec?
- ¿Tedta ushash dambiucudaid cute bëpin ambiunac bëdampec?

Bacuëmpibo chotaquën dauë isme, aid nibëdsho dadauaten icquidi isme.

Bëdambuen sauan istanquin annoshca. Adoshon madadauaid tsadun, sauan yacnombo.



Istanquin dadaua:



Dauë choquido

Dadampibobëd chidompibo dadauaquido nebi, mibi cun dadauate shubu yacno chomenu, ma ubi chedo bédambuen mucuquequin ismebannu.

Nëid ushën _____ ushë _____ icnuc.

Min cuëmëdaid:

Nuquin shëta dayunuanuna

Bacuëbo ismequid chido chiaid:

Bacuëmpibobëd onquenuna dauë choquid chomenun dadauaic.

Ma nuqui bédambuec mucuquiaid ismequin chuibannu. Adoshon naden chui:

- ¿Midapadec dauëchoquid chido o dada cuëmëdec?

Aden bacuëmpibon chuinubi mimbi dada uaic papedoten o pisadan.

Dadauaid bëdiactsëc chuiquin isban. Adshun mimbitsen isquin chuiban quequin bacuëmpibo chui.

Bacuëmpibo chui utsiembidi mitsipaden nuquin shëta dayunuac bédambo icpec, quequin.

Adshun chuiban nimëduc shëcpis dauë iquec, aidën nuquin shëta bédambo icmec ushumbo icnuc quequin.

Dauë choquidën cuëmëdaidbëta aid ushën mibi chomenu caid badiad dadaua.



Istanquin dadaua:

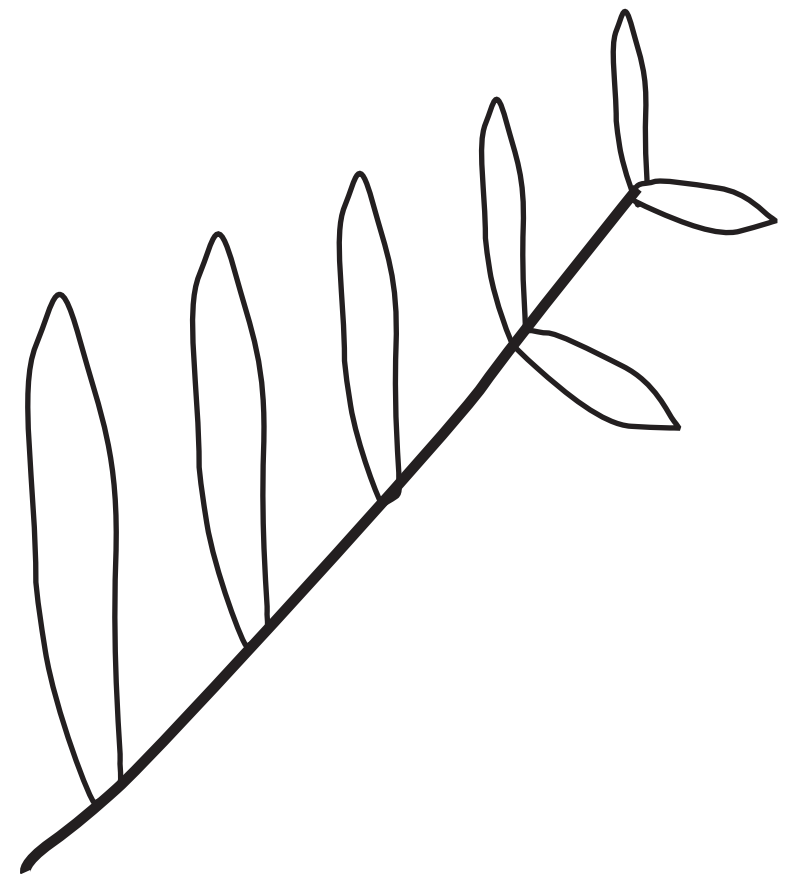
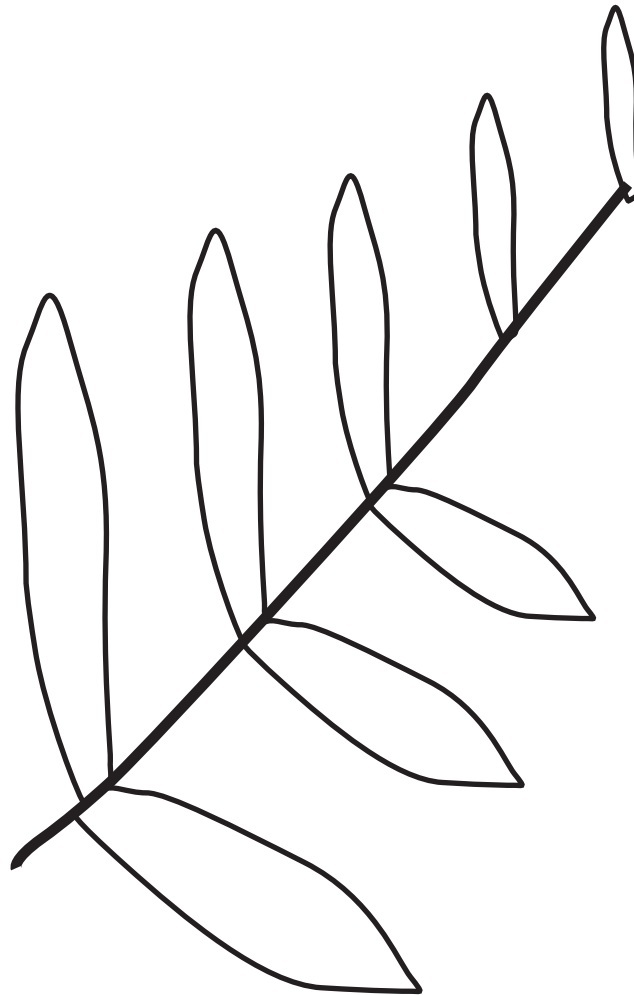
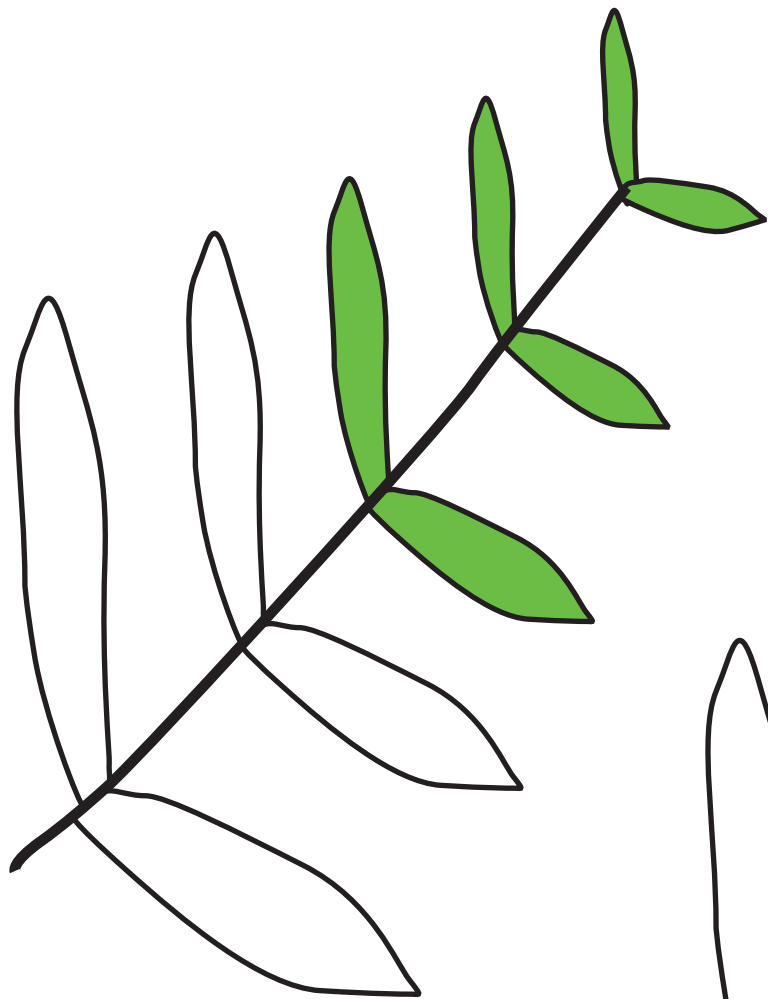
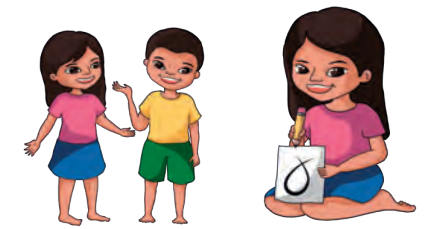

Min cuëmëdaid:.....

Mitsipaden dëunquin bëdanmetiad

Bacuëbo ismequid chido chiaid:

Bacuëmpibo tantiame ¿Mitsipad ique toshoquec?

- ¿Mitsipaden titan mibi bëdanmepec?
- ¿Atoda nesten tosho bëdampec?
- ¿Atoda nesten nënaid utsi bëdampec?

Aden chiac bacuëmpibon chuibansho pisadan dadauabanshun, tosho taëshun nabannun dadauabannuna.

Tantiaquidën neste bedaid shocoshëmpin bëdambuen tsuctoquin. Adotanquin bëdiambo chuuatanquin manesmequin, shicmishquin. Daëden o udictsëqui nesmequin.

Adotanquin bacuëbo nate bunquidën tanec cho ca. Titan nënquid icsho neste nacnenshun nesmiacbimbuen tambeded.

Adotanquin bacuëmpibo chui:

- ¿Atoda neste nëbi nuqui anquiadpo?
- ¿Min matsesën atotsi neste bedpec nënaid icsho?

Ambi dadauatequid menebantanquin aden na quequin chui.

Neste podo istanquin 10 ted yadmequin sauan dadauaban.



Istanquin dadaua:







Min cuëmëdaid:.....

Neste bēdanmianquidēn nesnuna

Bacuēbo ismequid chido chiaid:

Bacuēmpibo tsidadme daēd-daēdquieci icnuc.

Adshun papedote meneban abi
dadauatebētabi.

Adshun chuiban ma abi bacuēmpi iquec
icnēdaid dadauanu.

Aden nacsho papedote bedshun dectan ma
abitedishun isnu.

Adoshon chui:

- ¿Atoda utsi tantiadquieci iquec mibi
bacuēmpi icnēdaid?
- ¿Atoda pionda?
- ¿Midapaden nesmiondash?
- ¿Atoda mibi caundash?

Bacuēmpibobēd pisid daēdcaidēn
tabadbudshun ēnden chuinedaid chuiban.

Ema estidon yacnocquid champi nec. Aid
tishac chuca ictsēcnuc aton buchidobēd
aton chi nimēduc nidanniondash, machinte
chiquec.

Aden machinte chictanec choshon champi
tishac chucactsēcshobi machinēdaid
nēnenquio iquec.

Nēbi aton seta 8 ted yanac. Dadauaquidquio
iquec bēdamboshē nēbi Ema iquec.

Emabēta isaquēn sauan icquid annoshca. Adoshon abi ēnden icnēdaido chuiquin mimbi tantiacpadembi dadauaban.



Istanquin dadaua:



Min cuëmëdaid:.....

Bacuëmpi icshobi bedanquin nuqui nesmec

Bacuëbo ismequid chido chiaid:

Bacuëmpibo chuiquin tantiameban. Mibi chedo tishac chucampibo ictsec natia shubiondac, acquiec camidbudnenuc min nicchun piumbo iquec tsadcuenondash.

Adsho isash papa ënden isucunash niud dauë bedec nidondash. Aden bedtanacsho titan bédambuen tsuctotsëcshun chuuatannequin mibi nicmishac bédanondac.

Bacuëmpibo chui:

- ¿Midapaden bédanmepec pucu nëncuenacsho, toshoquesho, utsibi nënsho? ¿Midambo buamepec?
- ¿Tsutsi chuipec mibi nëncuenan?

- ¿Atoda neste isonda?
- ¿Tsundan nuqui bédanmepec nëncuenacsho?

Ambi nabantequid dadauate meneban. Adshun ambi tantienquio icaid nashun.

Abimbo yacno semequin simban atodactequid neste neque.



Istanquin dadaua:

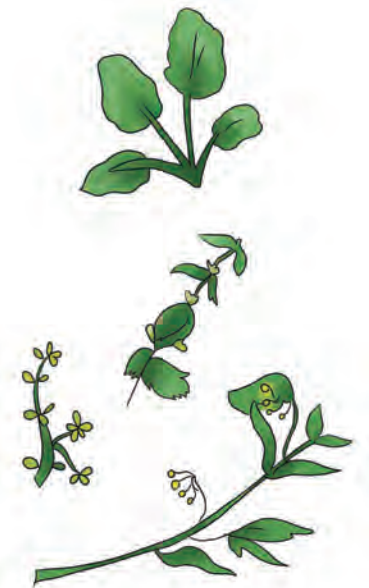
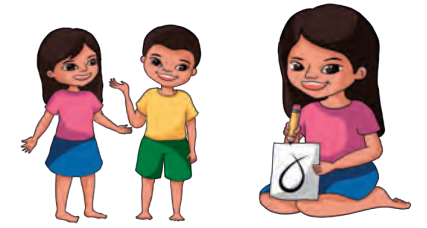

Min cuëmëdaid:.....

Mitsipaden matsesën nesmepec

Bacuëbo ismequid chido chiaid:

Umanuc puduenshun neste tabadacno istan.
Adoshon chui ada ambi isaid neste iqueque.
Aden isbanquimbi matsesën neste aden
tantiabempac cadennec quequin chuiban.

Ënden matses chidobëdi dada unësbudnepak
cadennec, nënaidën. Shëta nënec, cuidaidën,
utsi nënaid chedombi. Ad icnubic. Taëmiuësh
aton chidobëd choquidën chuipac cadennec.

- ¿Atoda quiash matses unësbudnec,
aton neste dadpen icnubi nënaid
bëdanquido?

Adotanquin nimëduc neste ismequin buampac
cadennec. Aden neste bedshun nesten
nesmequin ismepac cadennec.

Dadauate shubu yacno choshon chuiban,
midapad ënden chiaid tantiadec quequin.
Adoshon chuibanme ada nesten nënquid
bëdanmesho isnëdaque.

**Neste tantiaquidën natequid yacnobëta dauë choquidën natequid istanquin abimbo
yacno semequin simban.**



Istanquin dadaua:



Min cuëmëdaid:.....

Bëdambo yacno neste nannuna

Bacuëbo ismequid chido chiaid:

Bëdambuen tëshquën nacnenambobi nidanneme.

Adshun padpidec pudued-puduedsho naden chui:

- ¿Atoda quiaid nëmbo nec?
- ¿Atoda quiaish icsapamboshë iquec?

Bacuëbon ëcbedbansho tantiatanquin, cuëdënte cuëdënme. Ma abitedishun dadauate shubu nuntan bëdambuen nacnenannenu, abi yacnobi sambanquin.

Abitedi nacnenacsho chui:

- ¿Mitsipad iccuedede?
- ¿Mitsipad isadec nëbi?

Aduac chuibasho tantiashun mibi bëdamboshë iquec tëshquën nacnenec quequin chui.

Adshun ada tsësio neste tantiquidën shubu isonda, midapad aton neste tabadondash quequin chuiban.

- ¿Midapad aton cute podo neste iccosh?
- ¿Midashunquio aid dayunuaush quequin chuime?

Adshun ambi nabantequid dadauate meneshun, tsësiodapa neste tantiaquid aton neste bëdambuen sanquin nacnenshun quequin chui.

Tsiuec bëca icquidën sauan nibën A6.

Neste tantiaquid tsësio aton neste bëdambuen dectanquin nashun. Adoshon midacquidën pucu bëdantsiashe istanquin bëtiquidua.



Istanquin dadaua:

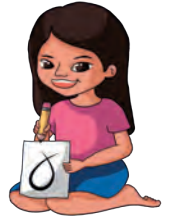

Min cuëmëdaid:.....

Anquiadacsho iste

Bacuëbo ismequid chido chiaid:

Tiquiduaquin bacuëbo tabëc. Adec tabadquin dadauamequidën chuibanec bacuëbo abi anquiadaid. Ma bëdamboen tantianu qeshun bacuëbo ismequidën naden chuibanec:

- ¿Midacquidtedi nuqui isedpo?
- ¿Tsuda chedo nuqui isedpo? ¿Adembidi tsuda chedon nuqui isedposh?
- ¿Atoda nuqui ismeposh?
- ¿Atoda nuqui tantiacmaid anquiadpo?

Aden tantiaquin bacuëmpibo ismequidën menebanec. Bacuëmpibon ambi nabante utsi-utsien ma sauan nanu qeshun. Adembidi ma annoshcanu qeshun. Adecbidi abi ushë abentsëquën anquiadaid tantiec ma utsi-utsien chieconquenu qeshun.



Istanquin dadaua:

Aton dadauaten dadauame, abi bēdambuec tabadaid tantiaquin
“Bēdambuec iccuededobi”







Bedanembi badiad chuiquin



Dunes

Madtes

Miedcodes

Uebes

Biednes

Min cuëmëdaid:.....

**Bitacca mēdantempi abentsēc dadauatsaid aid badiadēn mimbi mibētan
dadauaquidēmpibo, mibi ismequidbēta mēdinnēdacpaden.
Adembidi bitaccaban matses min daduate shubu yacno mibi isec chosho mimbi
mēdinnēdacpaden.**



Istanquin dadaua:



Bëdambuen ubëtan dadauaquidëmpibo isembi

Dunes

Madtes

Miedcodes

Uebes

Biednes

Min cuëmëdaid:.....

**Annoshca nëid quënëuaid min annoshcate utsi utsiequidën, badiadquidën-
badiadquidënquien bédambuen mimbi mibëtan dadauaquidëmpibo isaid.**



Istanquin dadaua:

Three horizontal dashed blue lines for writing.



Nianembi dayunuaid bëdambuen nacnenshun

Dunes

Madtes

Miedcodes

Uebes

Biednes

Min cuëmëdaid:.....

Badiadën bescaquin ushë dadauabanaid bitacca nashunac paden. Daduate shubu uquëduc mimbi nashunac paden.



Istanquin dadaua:

Three horizontal dashed blue lines for writing.

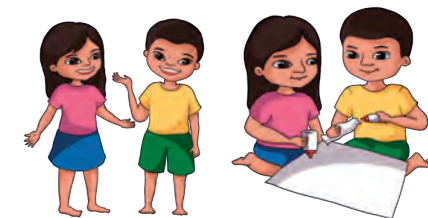

Menenanebi ubëd icquidëmpibobëd

Dunes

Madtes

Miedcodes

Uebes

Biednes

Min cuëmëdaid:.....

Sauan dadaua bētantete abentsēc mamēnquiecnuc, mibi mamēntequidbēd utsitedi nacnenaid naic iccuededbocpadquiocnoc.

Istanquin dadaua:





Pembi cun pete abitedi

Dunes

Madtes

Miedcodes

Uebes

Biednes

Min cuëmëdaid:.....

Bitacca chiun abentsēc bēdamboshē isadnuc, nashun badiaquidēn-badiadquidēnquien mimbi pebued.



Istanquin dadaua:

Three horizontal dashed lines for writing, located to the right of the girl's illustration within the rounded rectangular frame.



Adquid nebi cun
utsibobëd cun shubu
yacnocquidobëdtsen.



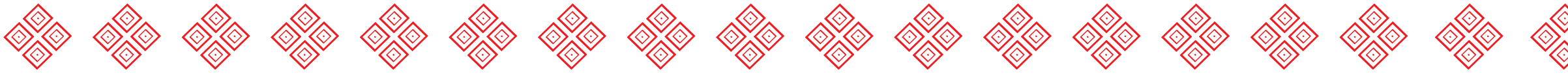

Nëid ubi nec



Cun cuëmëdaid nec _____

Nadquid icsho cuënaid _____

Cun seta _____ *iquebi.*

Ubi yacho nadeç cuëmëdec _____

Min cuëmëdaid: _____

Bacuëbon papa ani chedobëta chiaid.

Umbi buanaid cuntabëd cumpa chedo.

Dadauaid min champibëtan o min madobëtan isec onque.

✓ ¿Midacquid bacuëmpibimbuec isadec?

Min madobëta min champi chuiban abi tishnëdacno, midambo icquid neque. Tsuda chedo aid tishnëdacno icnëdashe chuibanquin.

Midapaden tantiondash aid cuënnu quequin. Adoshon chuiban adquid icsho mibi aden cuënondambi quequin.

Cuëmëdaid chuitequid icsho naden chiaid mibi cuëmëdaid nec, buchidobi cuënnu qeshun mibi cuënondambi quequin chedo chuiban.

Bacuëbon papa ani chedobëta chiaid.

Umbi buanaid cuntabëd cumpa chedo.

Onque min champi, min bacuëmpi chedobëd DNI icac bëdambo icaid chiec.

Aidi cuëmëdaid dadauaid abitedishun istequid nec quequin chui.

Abitedimbo Perú yacno tabadquido icaid nec. Bacuëbona bëshpiu-bëshpiucquid nec.

Aton cuëmëdaid abitedi dadauaid nec.

Abi tishaid dadauaid. Abi bedcaid iquec aid nec quequin istequid. Aidëmbi abi dadauaic puduedte bëdambo icmec,

Abi dauë shubu yacnoshon nashuntetsen iquec. Pete nashunaid ictequid, dayunuaid icte, bëdambo

Dadaua min DNI numedo tëshquënëmpi ëquëduc.



Cun pete ubi bunaidquio



Min cuëmëdaid:.....

Bacuëbon papa ani chedobëta chiaid.

Umbi buanaid cuntabëd cumpa chedo.

Min mado, min champi quec tabadquin sauan isec onquequin tantiaméban.

Min pete mibi bunaidquio. Chui:

✓ ¿Midacquid pete mibi bunquiaid nec?

Chui midapaden codocapec, quequin.

Adotanquin min bacuëmpi nashun sauan bitaccaquin, adembidi sauan nashun annoshcame aton pete abi bunaidquio.



Ubi mamönte bunaidquio nec

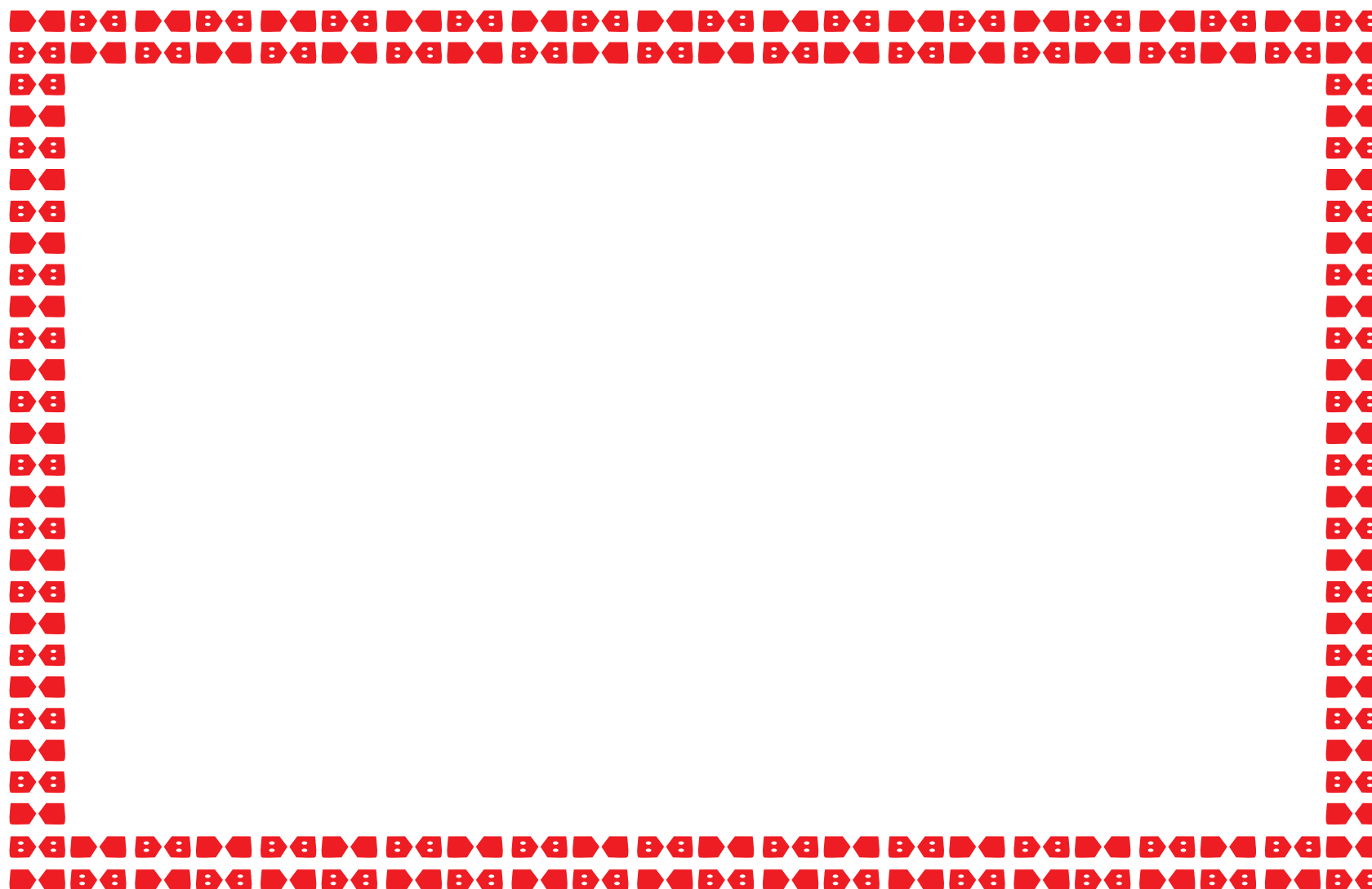

Min cuëmëdaid:.....

Bacuëbon papa ani chedobëta chiaid.

Umbi buanaid cuntabëd cumpa chedo.

Dadauaid min champibëtan o min madobëtan isec onque.

Abi mamënte bunaidquio chiec. Adshun naden chui:

- ✓ ¿Mitsipadquid mamënten mamënte bune?
- ✓ ¿Mitsipad ique mibi mamënte bunaidënquio mamënec?

Min bacuëmpi chedobëd daëdpactsëc mamën ma bëdambo icnu.

Adoshon mibi bacuë iquec mamënte bunquionëdaid chui. Aden chuitanquin min bacuëmpi o min champi bitaccabanquin nashun. Abi mamënte bunaidën sauan dadauaid annoshcabanquin chedo.

Cunta nadquid nec

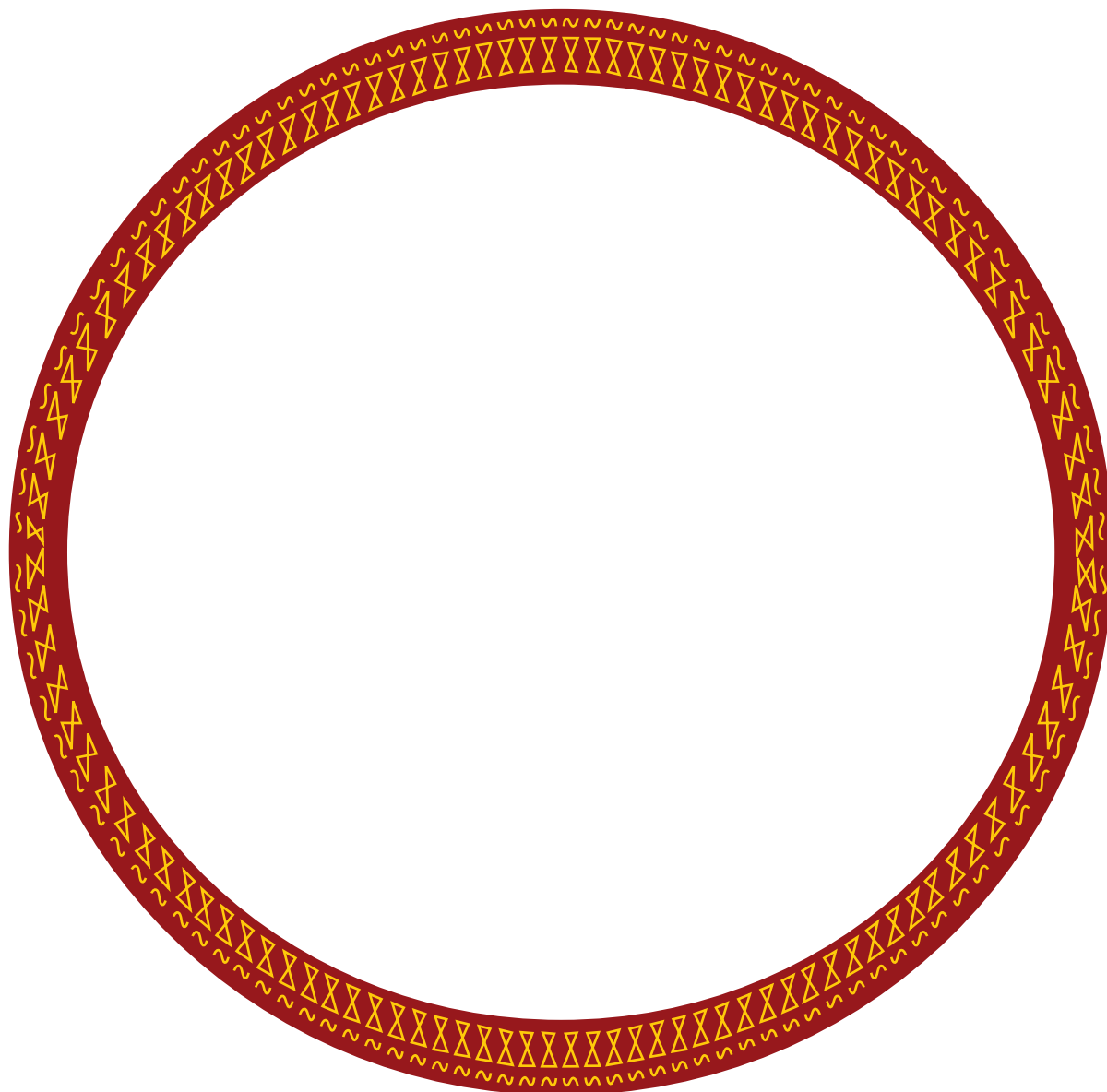

Cuntan pete abi bunaudquio.

Tita tishte ushëc icnuc menequin
cuishoncamete.

Cuntan cuëmëdquid

Cunta icacno

Cunta icacno

Cuntan seta

Min cuëmëdaid:

Bacuëbon papa ani chedobëta chiaid.

Umbi buanaid cuntabëd cumpa chedo.

Dadauaid min champibëtan o min madobëtan isec onque.

Onque mimbi pete bunaidquio chiec. Adecbidi aid codocanun nate chiec.

Adoshon naden chui atodambo bëdaidquio meniadte buntsia mibi tishaid ushë icnuc.

Adotanquin min bacuëmpi o min champi sauanëmpi bitaccabannuna quequin chui.

Sauan dadauaquin, abi pete bunaidquio annoshcaquin, abi cuishocamete chedo naban.

Bacuëbon papa ani chedobëta chiaid.

Umbi buanaid cuntabëd cumpa chedo.

Dadauaid min champibëtan o min madobëtan isec onque.

Adoshon naden chui atodambo bëdaidquio meniadte buntsia mibi tishaid tantiaquin.

Adotanquin name min bacuëmpi o min champi sauanëmpi bitaccabannuna quequin chui.

Sauan dadauaquin, abi pete bunaidquio annoshcaquin, abi cuishocamete chedo naban.

Cun chu chedoböd cun buchiado



Cun chu chedo

Cun buchibo

Min cuëmedaid:

Bacuëbon papa ani chedobëta chiaid.

Umbi buanaid cuntabëd cumpa chedo.

Dadauaid min champibëtan o min madobëtan isec onque.

Chuchun sauanbëta buchina na quequin chui. Adshumbic aton cuëmëdaid abi bunacpadembi dadauame sinsinacno tsiuec.

Nëidën nesmiondashi



Bacuëmpi ischo nëidën nesmiondashi

Nadshun nesmiondashi

Aidën

Min cuëmëdaid:

Bacuëbon papa ani chedobëta chiaid.

Umbi buanaid cuntabëd cumpa chedo.

Dadauaid min champibëtan o min madobëtan isec onque.

Min madobëta, min champi chui midapaden tantiaquin nesten nesmiashe.

Adembidi a toda nesten nesmiashe.

Naimëdacno sauan dadaua. Adoshon annoshca neste.



**Ubi yacno icquid
nëish tedi**

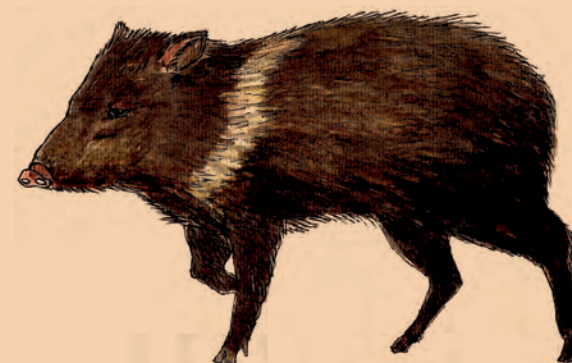
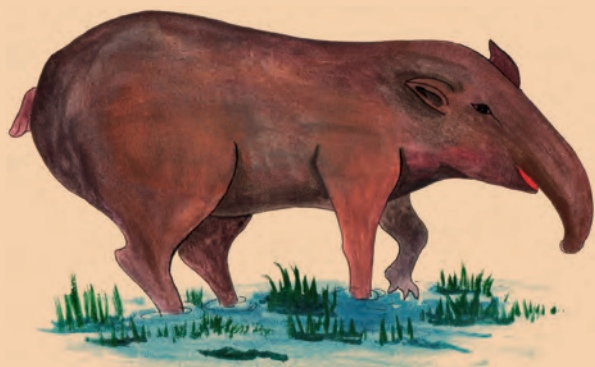



Poshto



Tsistsis



Piush



Tsaues



Tambis

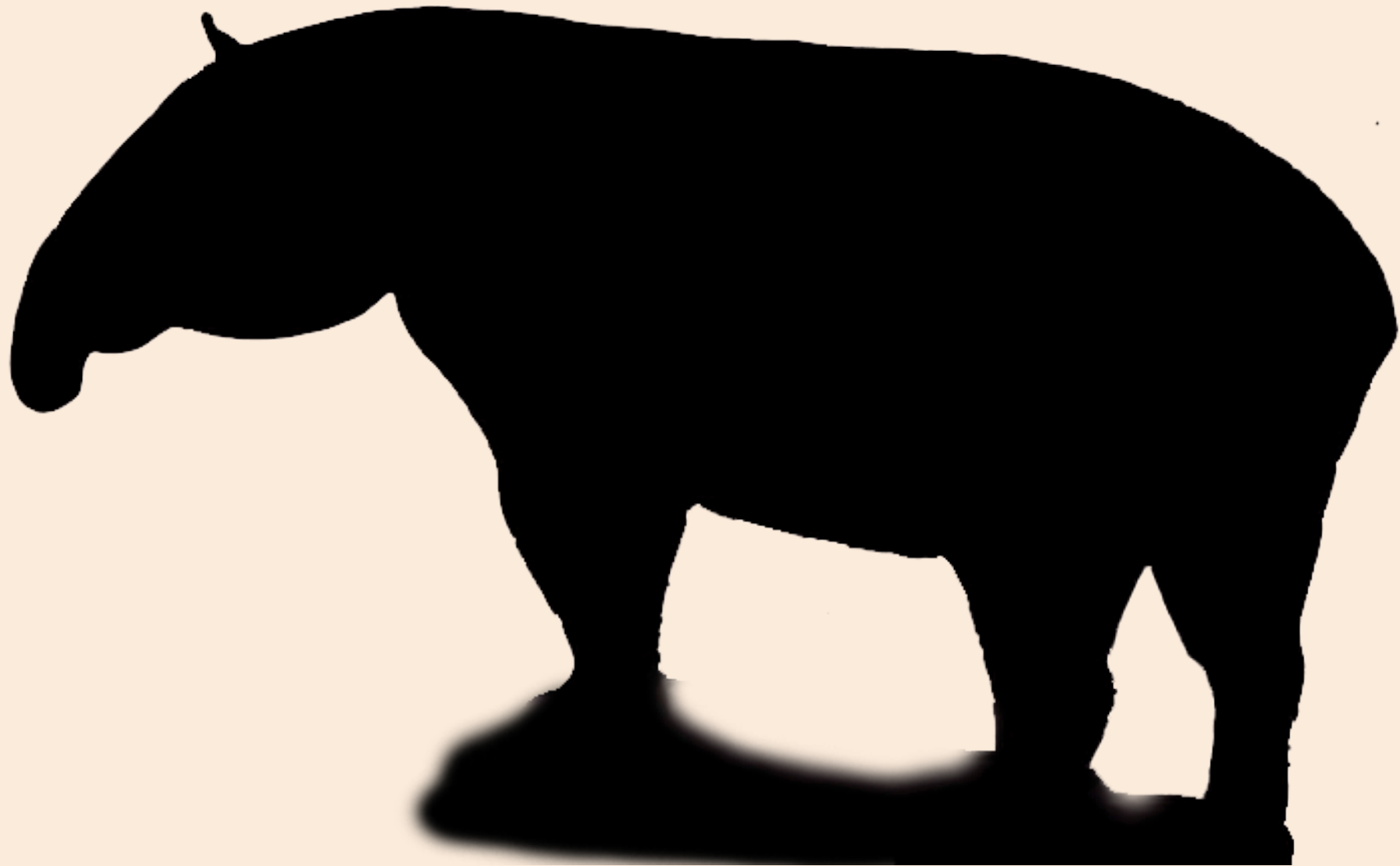

Näishamë



Cana



Min cuëmëdaid:.....



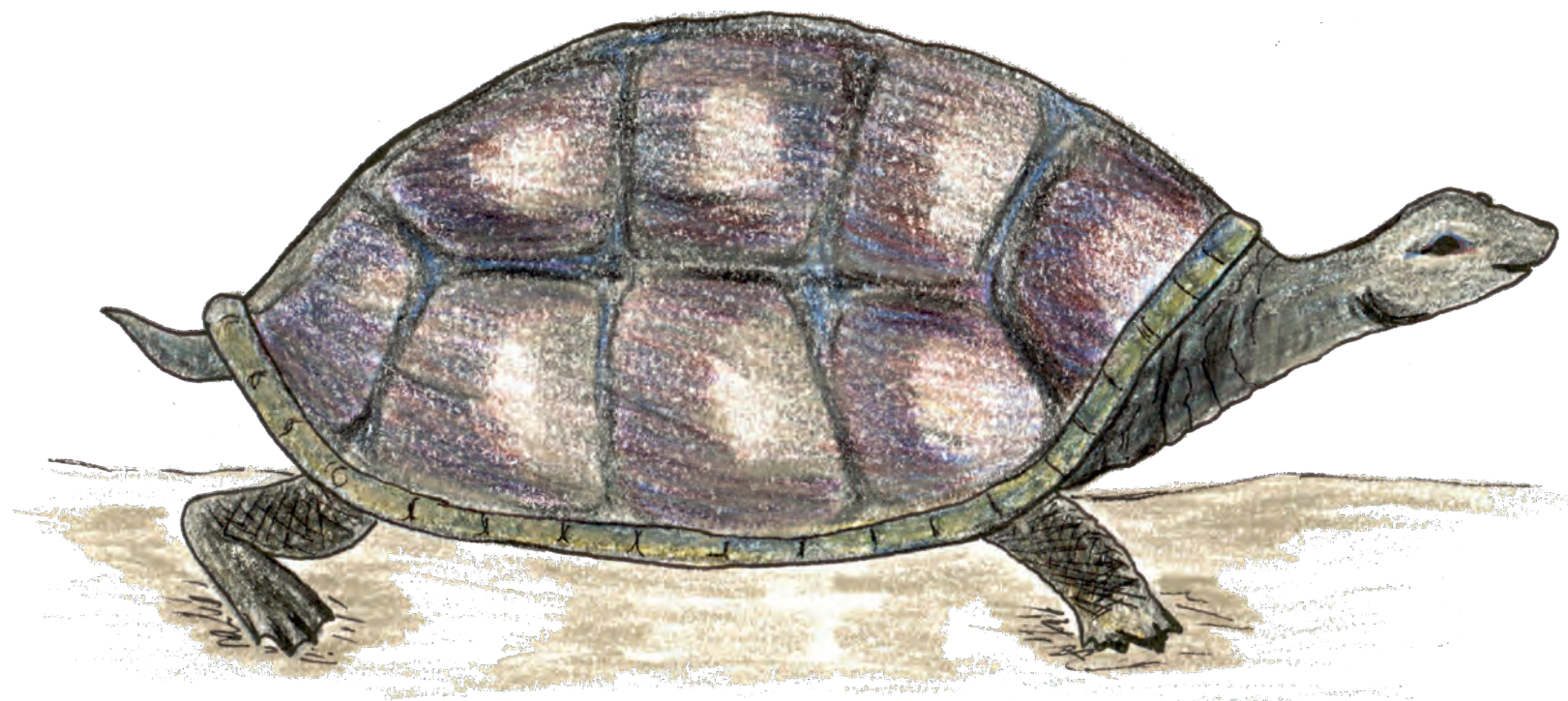

Min cuëmëdaid:.....



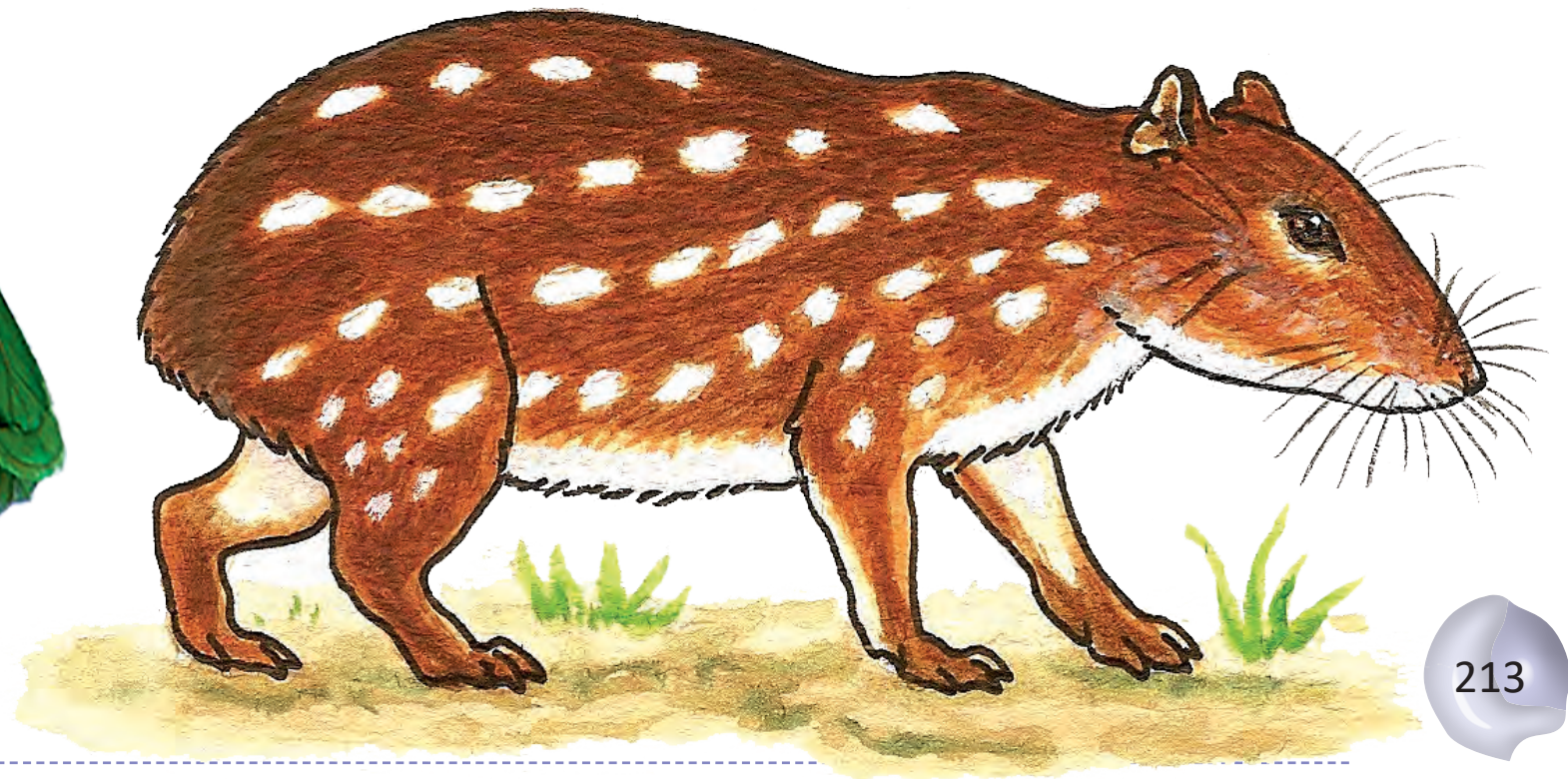

Min cuëmëdaid:.....



Onquec chuinnuna







Min cuëmëdaid:.....

Dadauamequid chido onquiaiad chuiquido onquiaidtsen

Mimbi tantiac paden chui tedefono adquid nec quequin.

Bacuëbo ismequid chidobëta chuiquido chiaid.

Matses ambo ista caid onquenu quequin chui. Ma tedefono besecainquiocquin bédambuen bacuëbon dayunuanu, cudasnanenquiocquin.

Nadec onquete nec quequin bacuëbo isme.

Mibi icacnocquid numedo chuime, adoshombic matses icacno nëbictsëcqui yacnocquid numedotsen chuimeua.

Mibi yacnocquid onquete "tedefono" numedo istuid. Numedo chedo annoshcaban. Adoshon sinaidën numedo dadaua.



Istanquin dadaua:

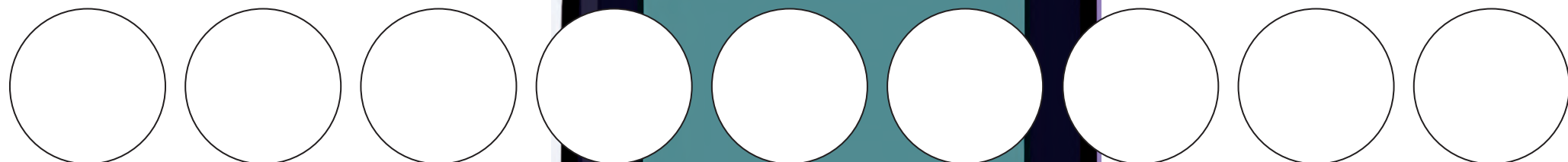

Min cuëmëdaid:.....

Mibi ismequidën “sedudad numedo” istuid, chuiquidëna o min papana. Adshun numedo mamishte yacnocquid annoshca.



Istanquin dadaua:

Three horizontal dashed lines for writing, located to the right of the girl's illustration within the rounded rectangular box.













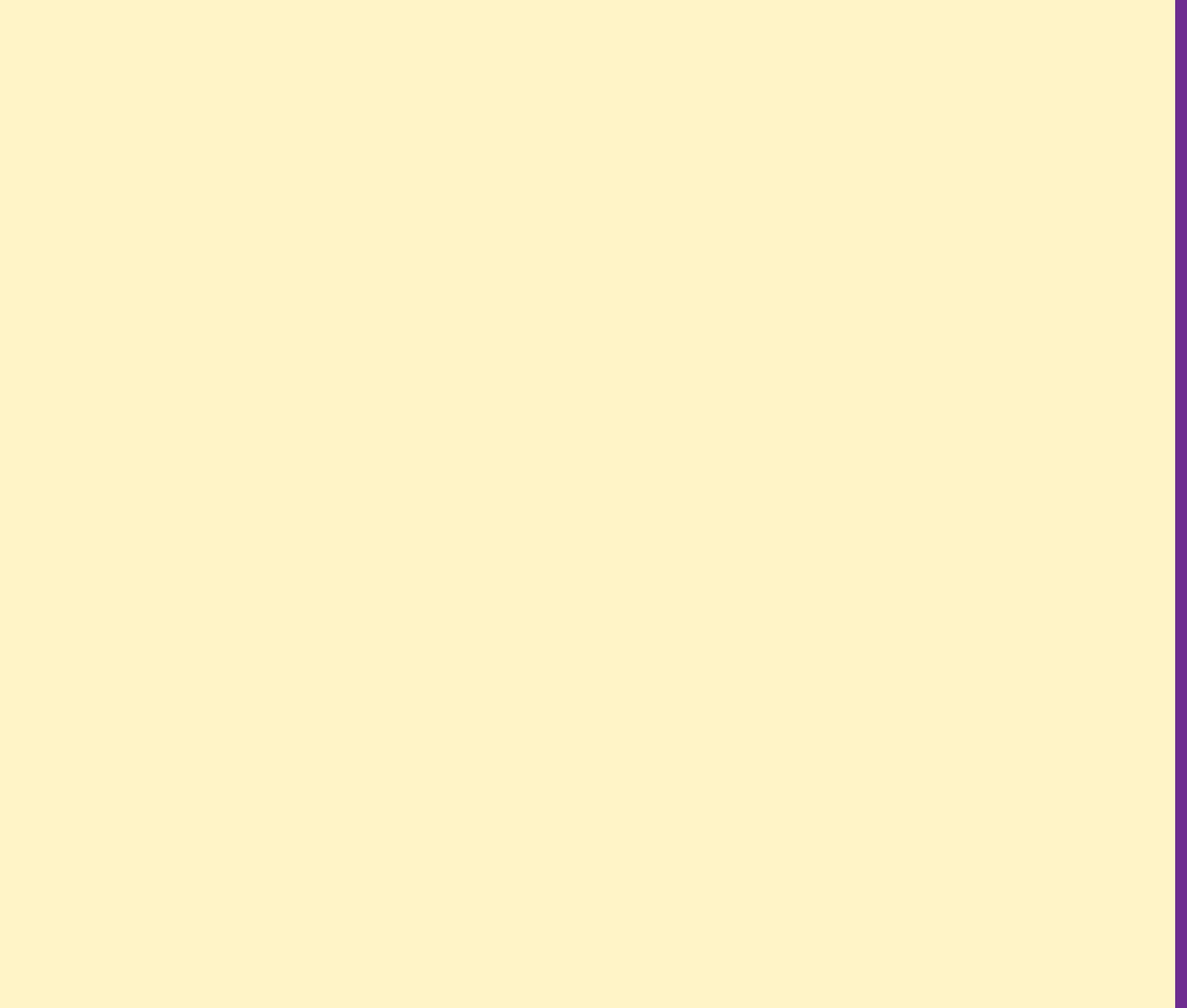













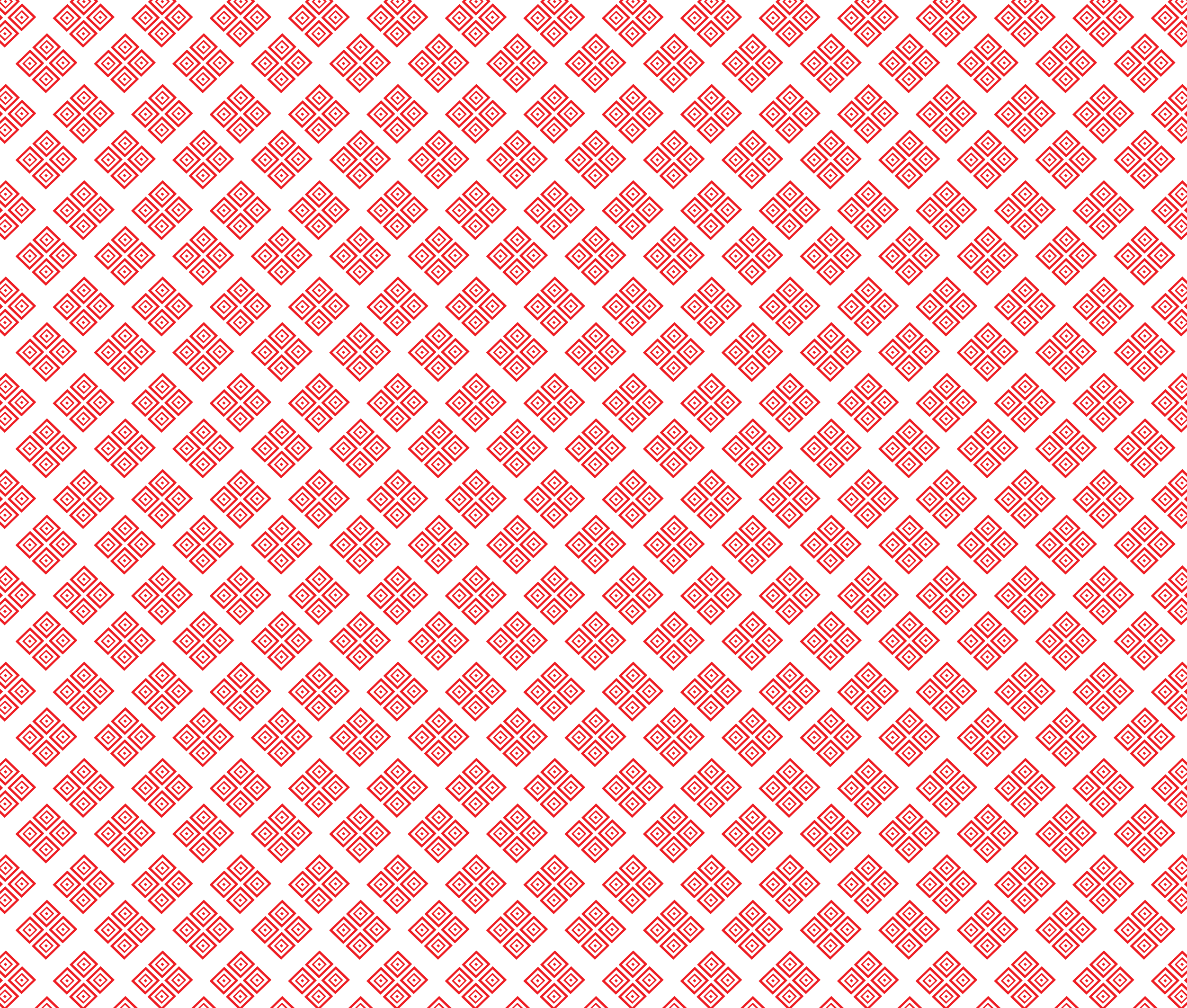

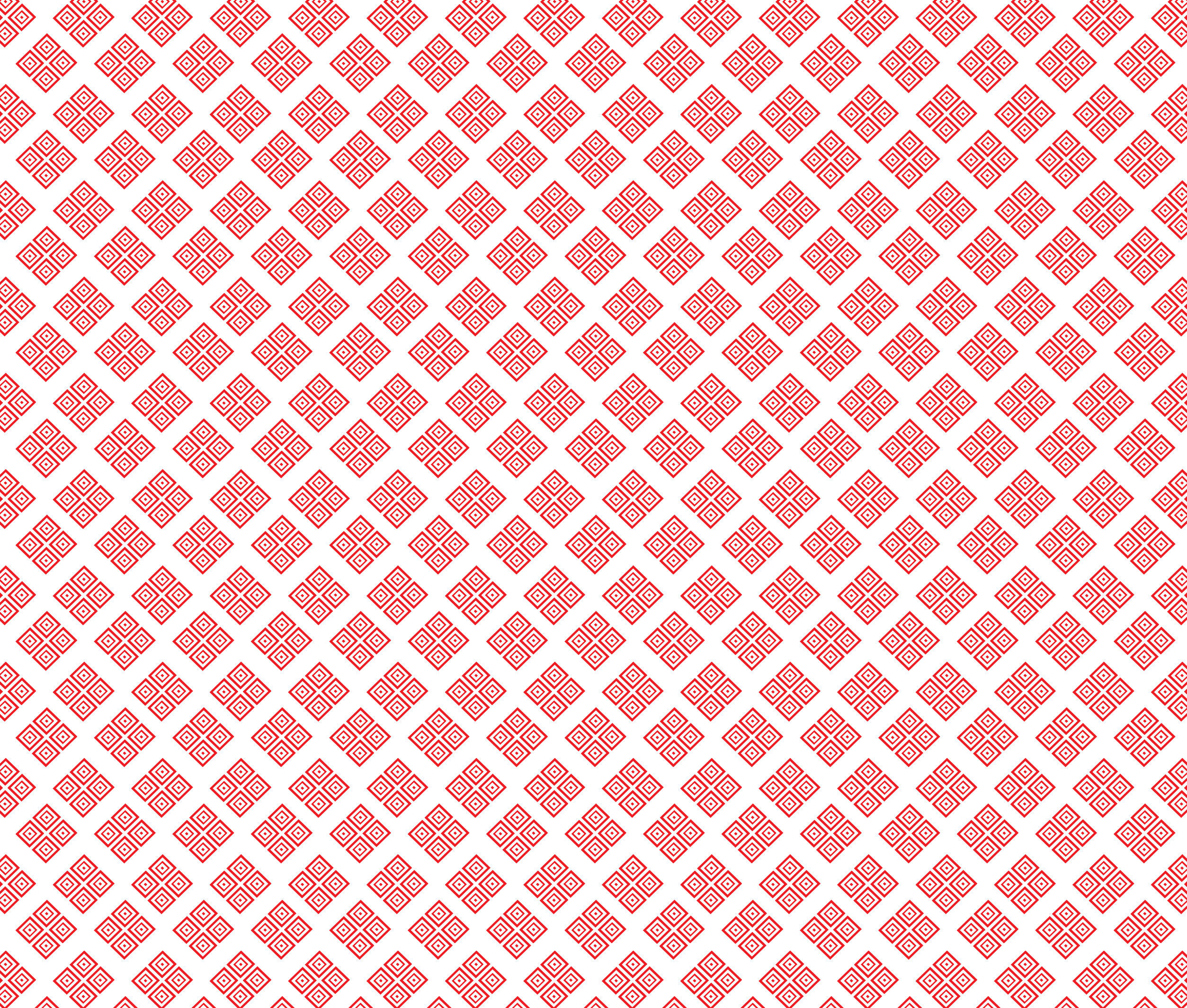

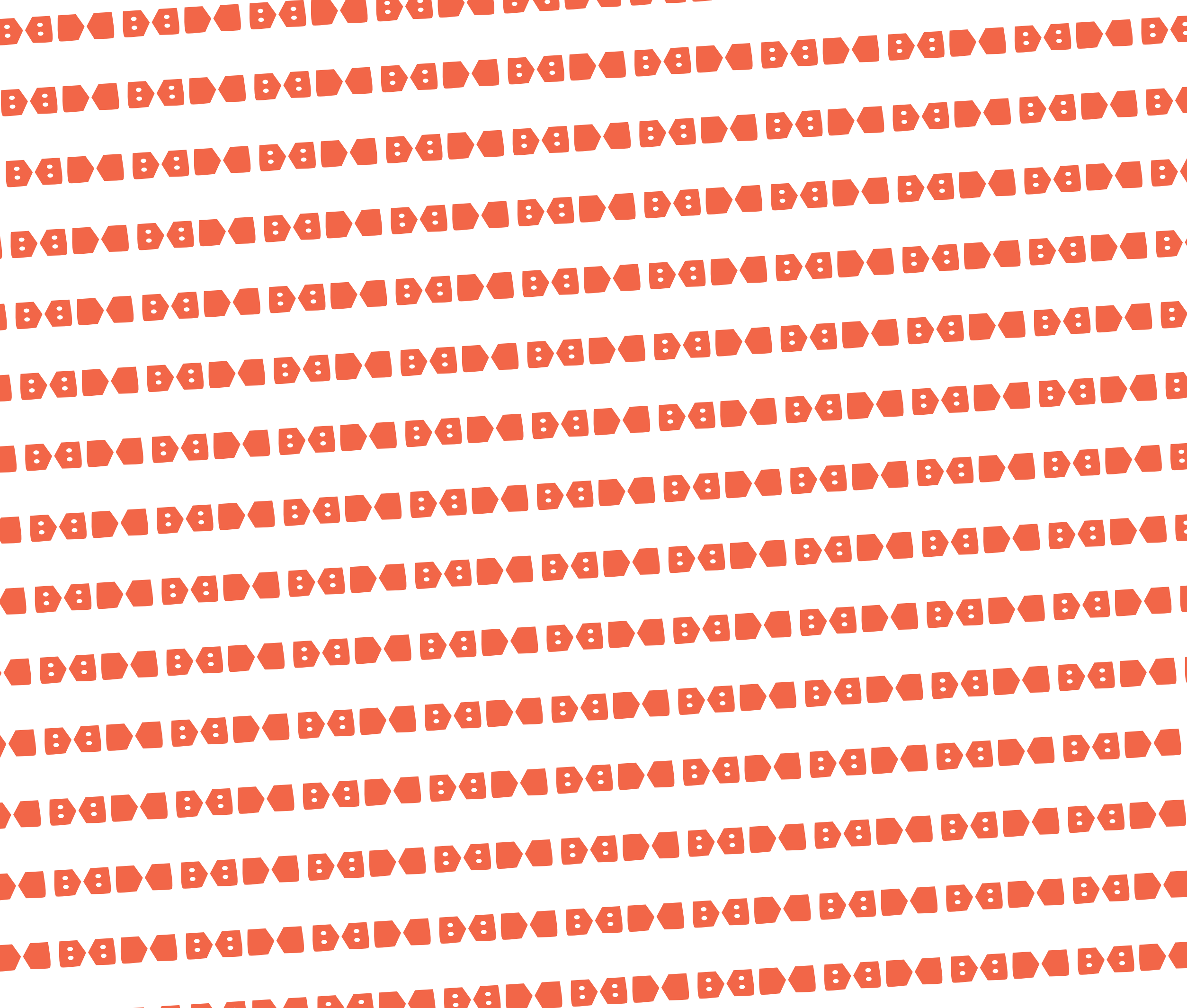

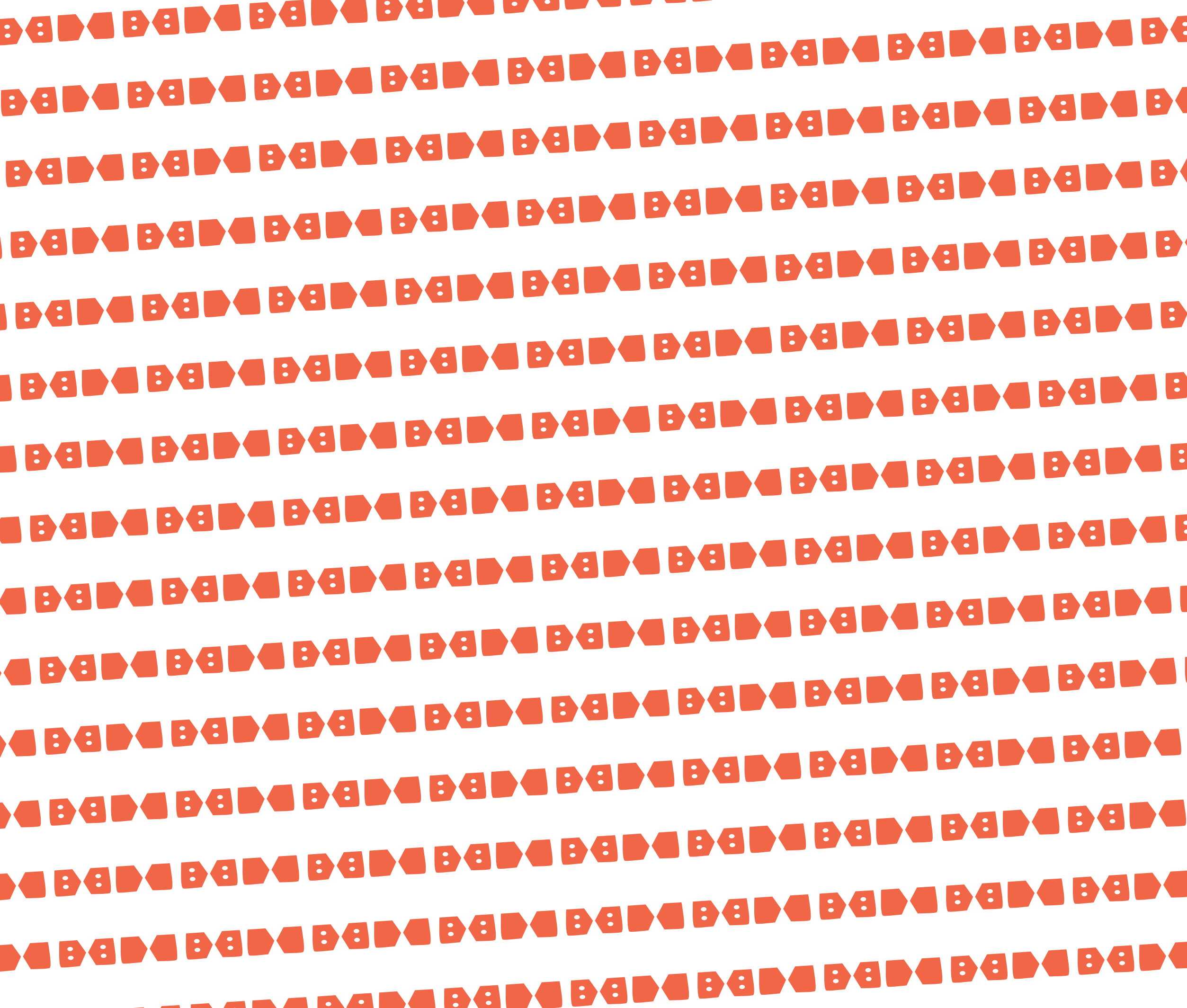

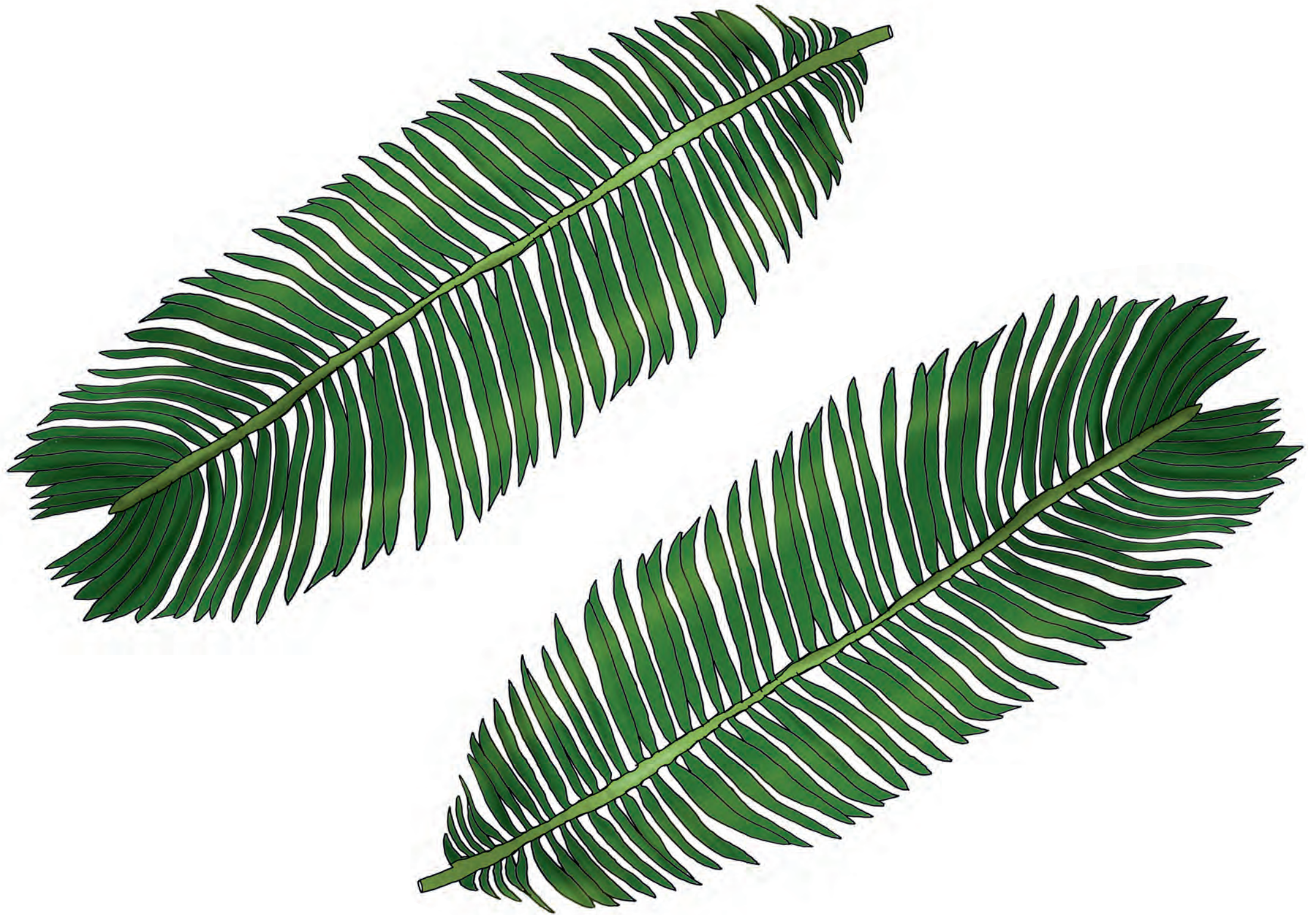

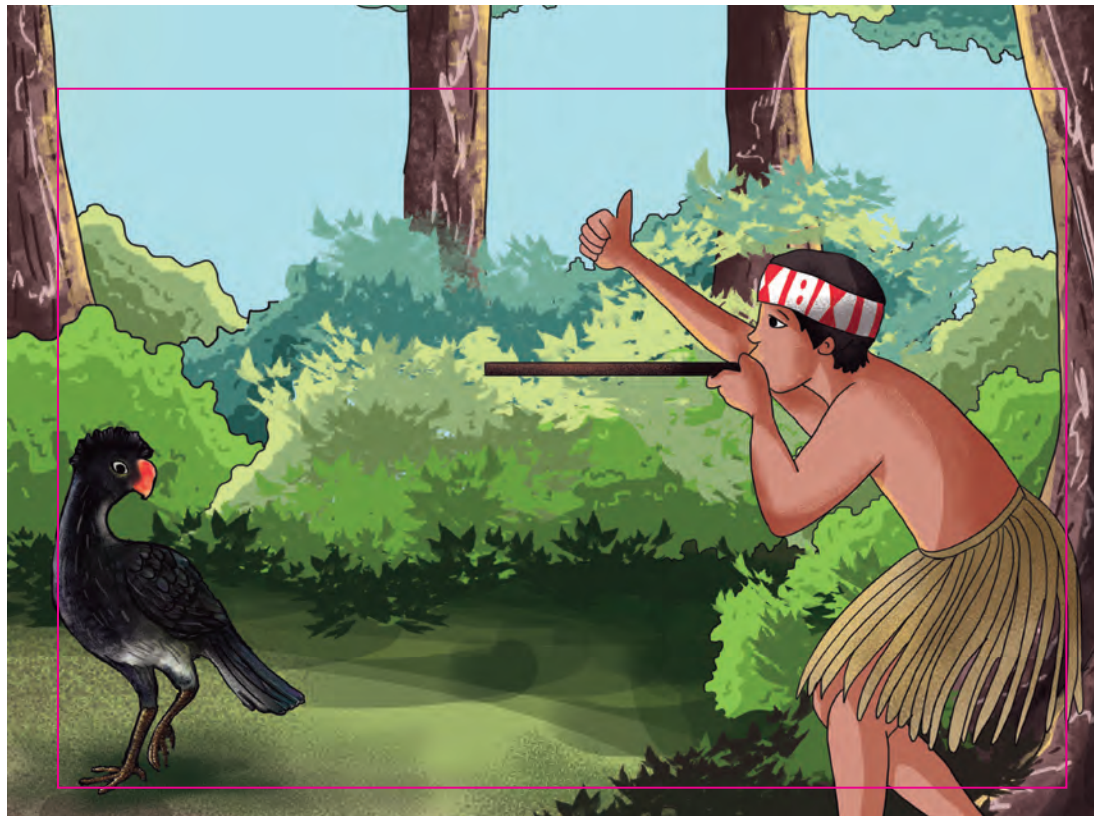



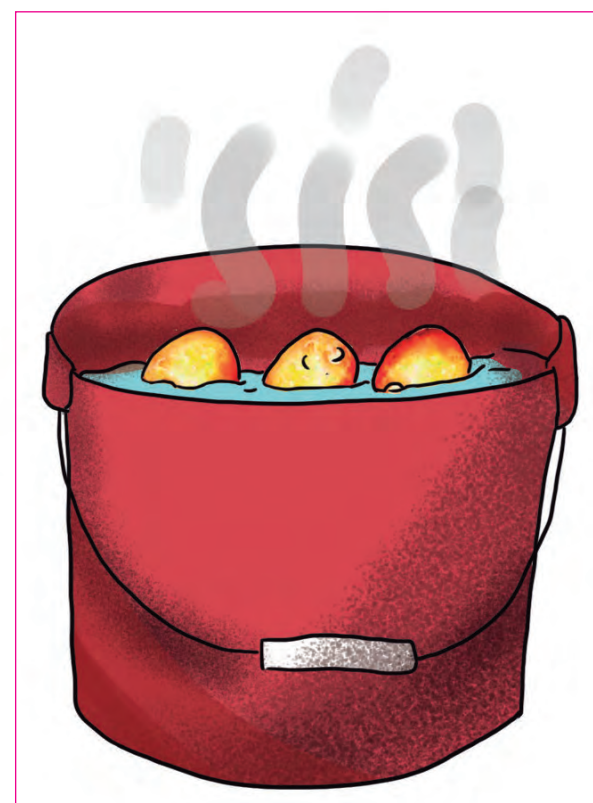
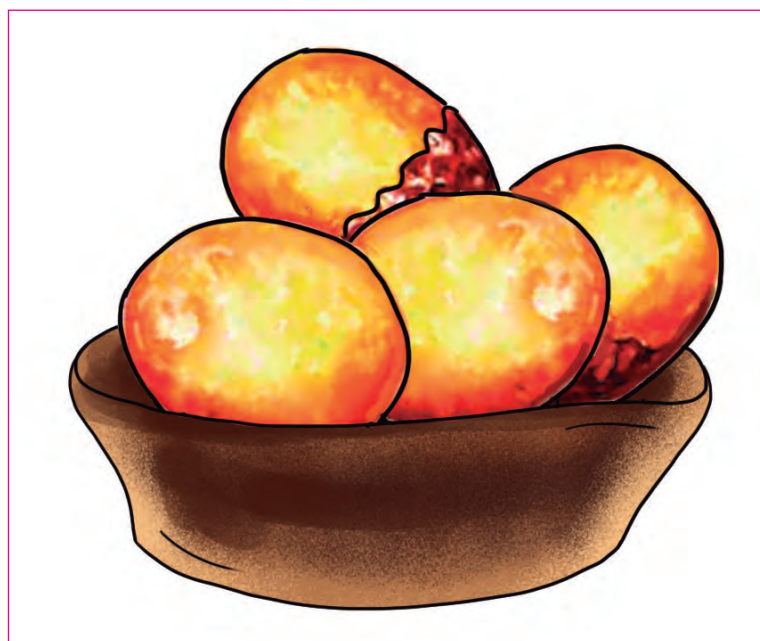
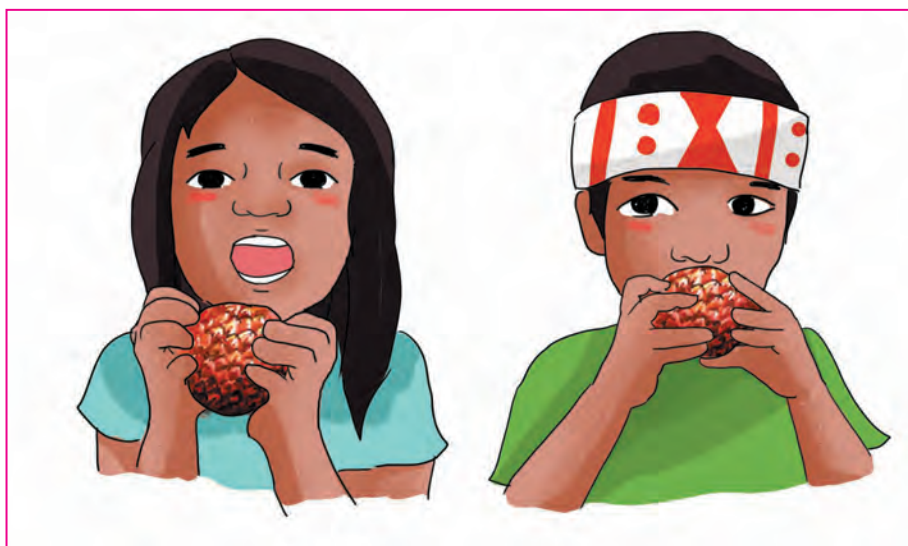
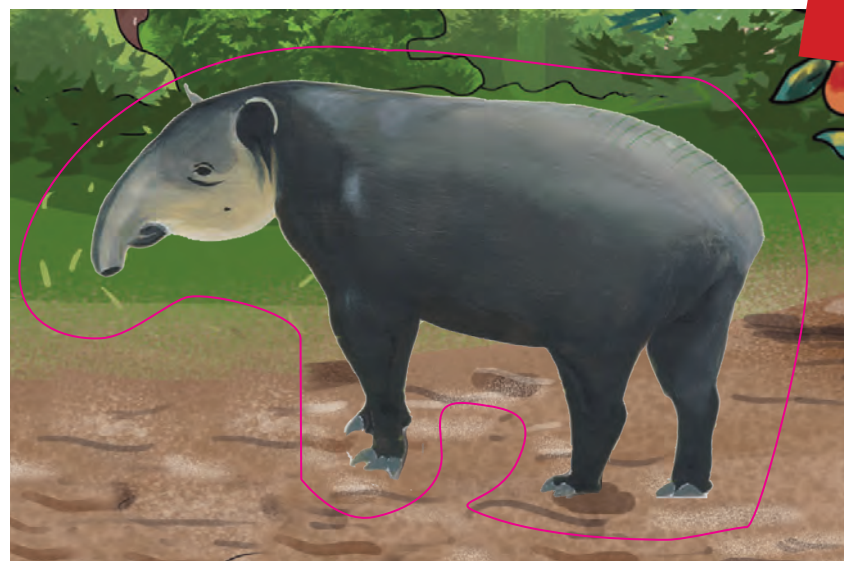
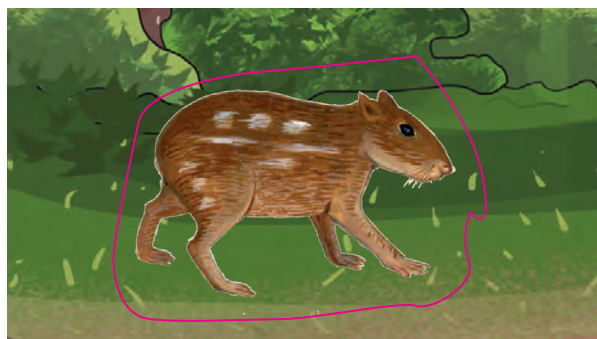

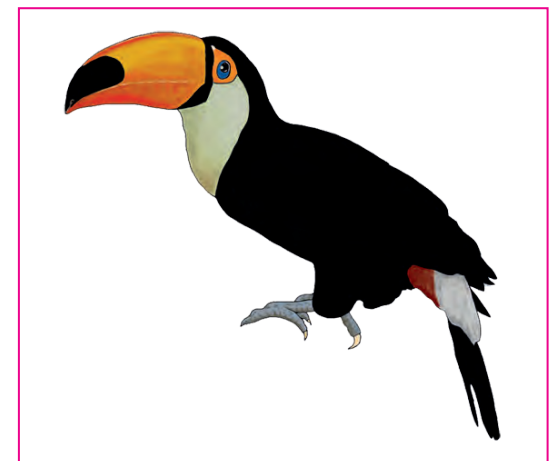
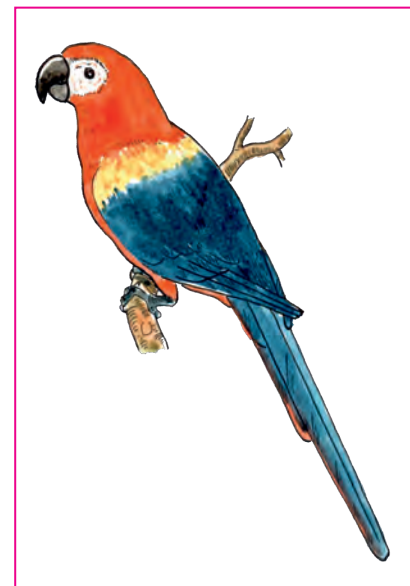
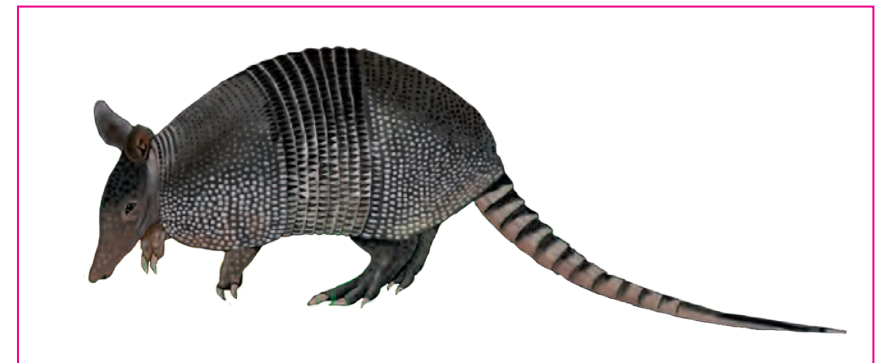
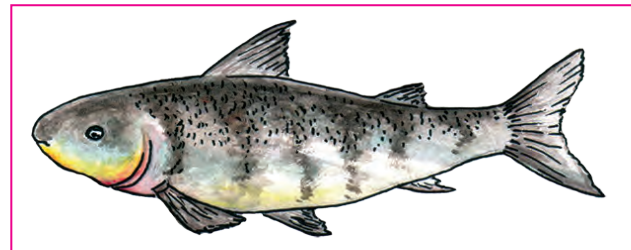
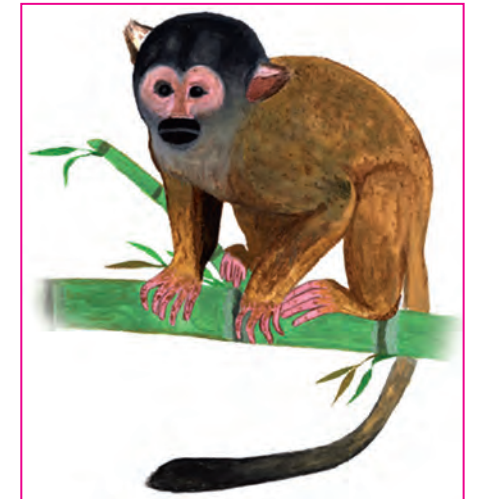

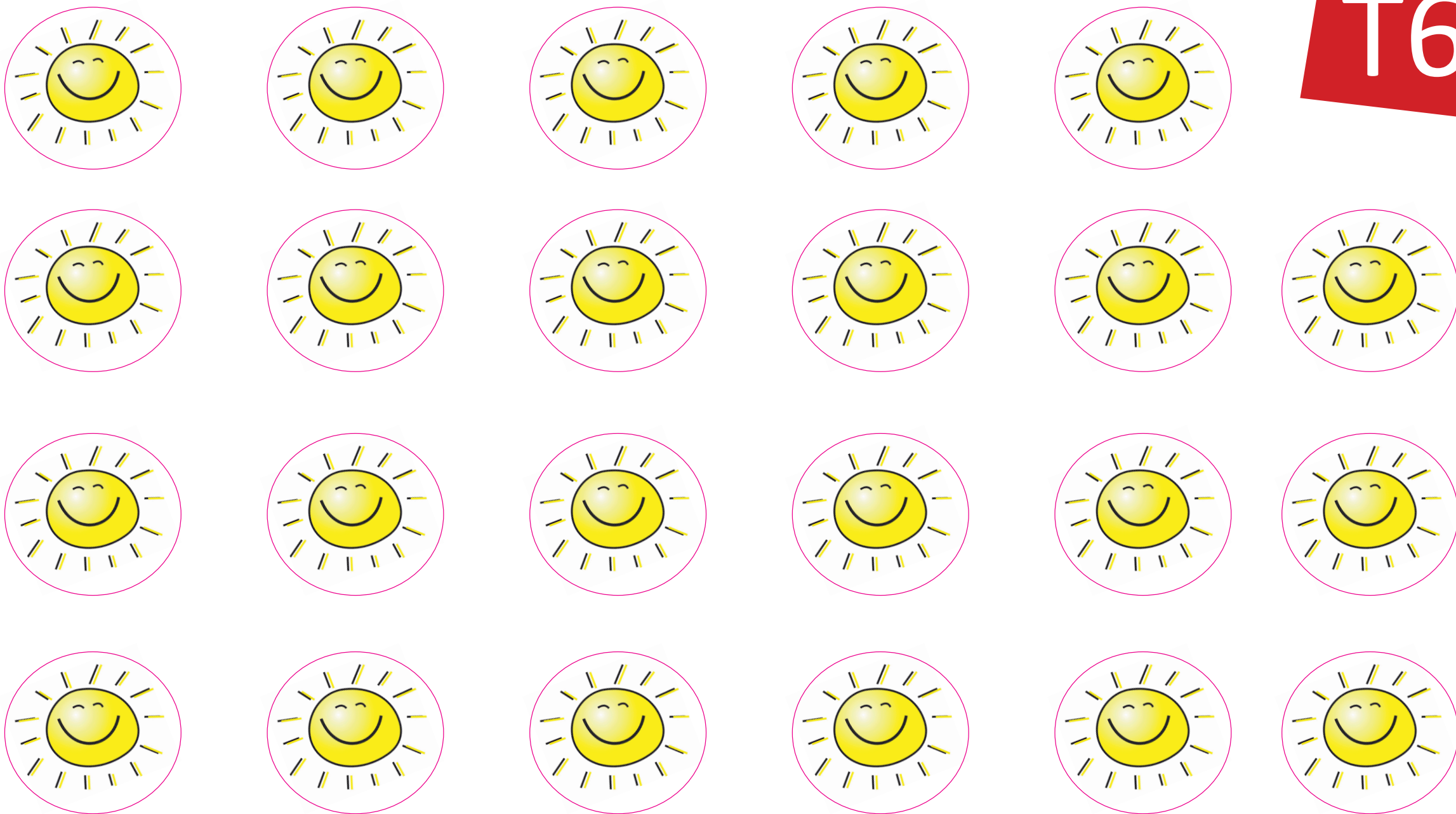

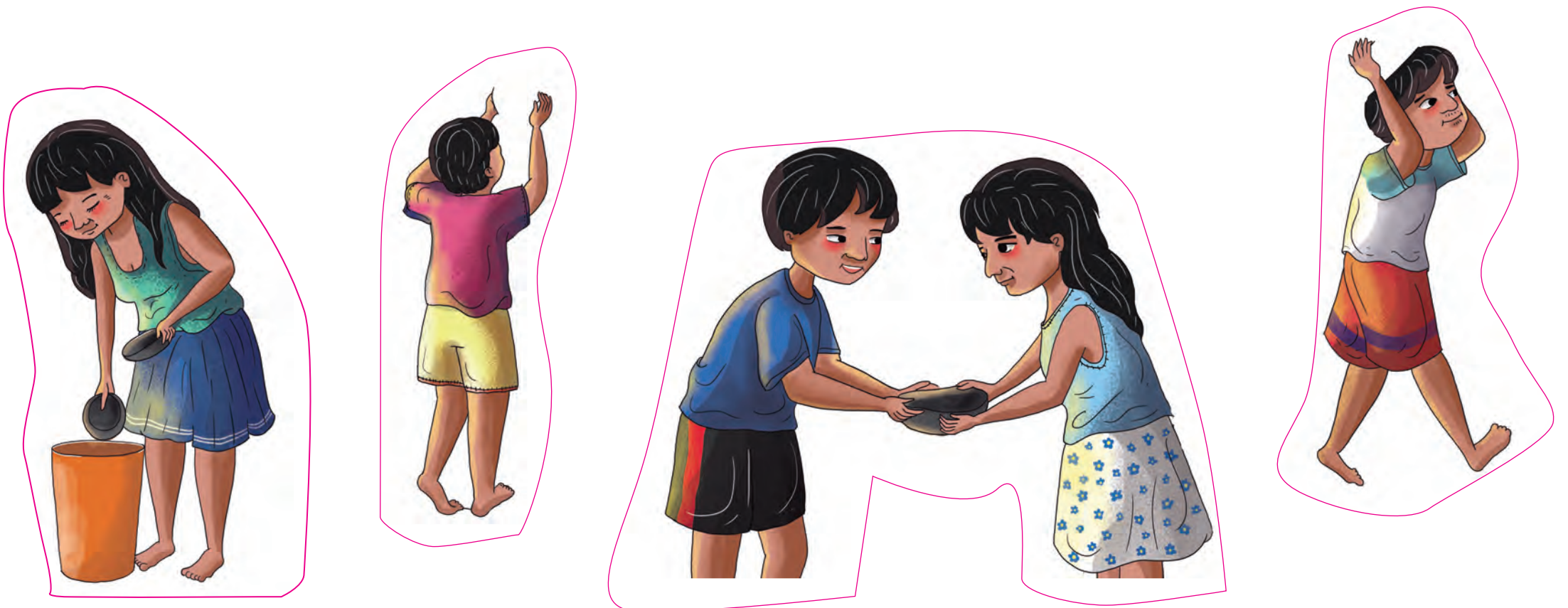
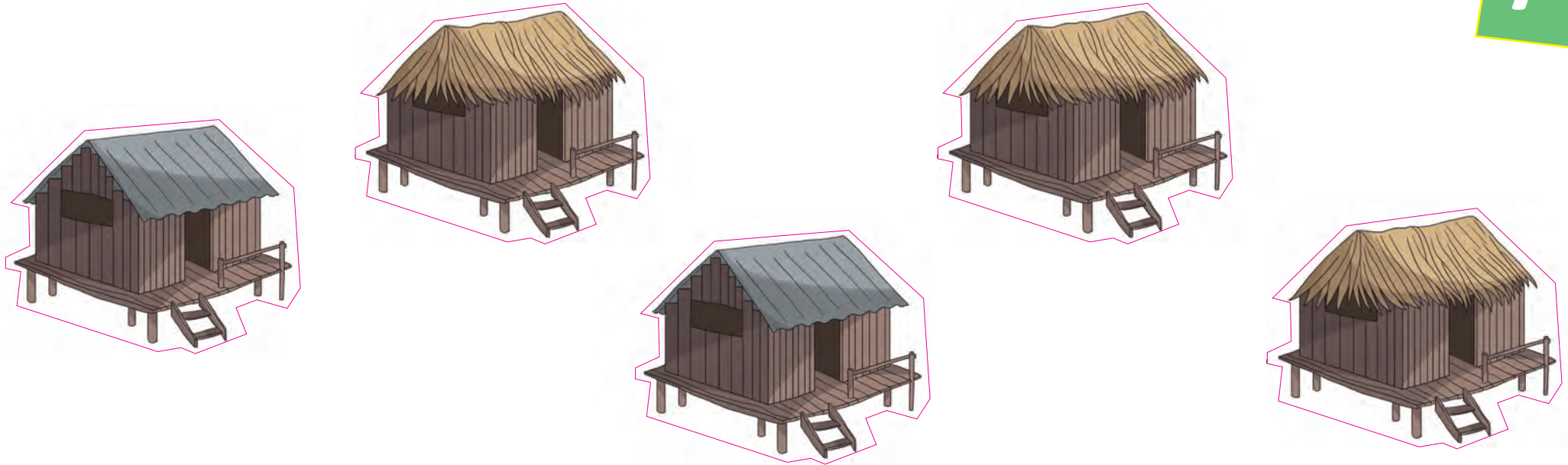

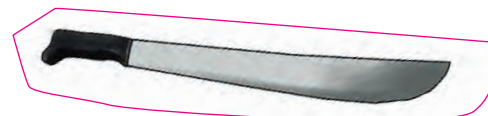
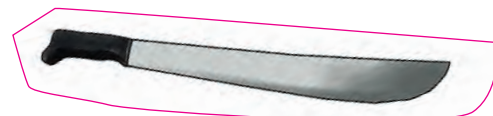
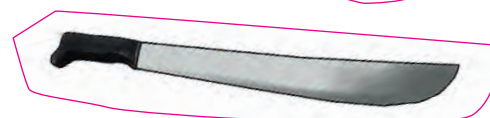
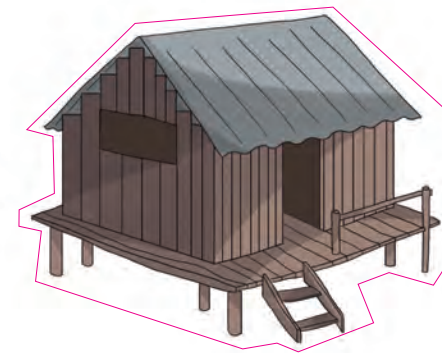
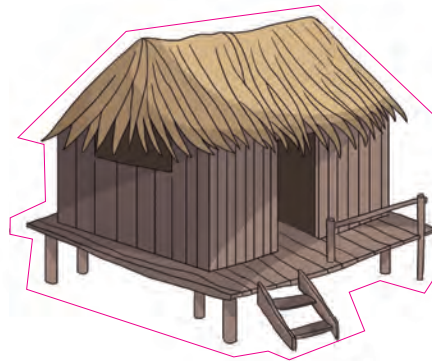
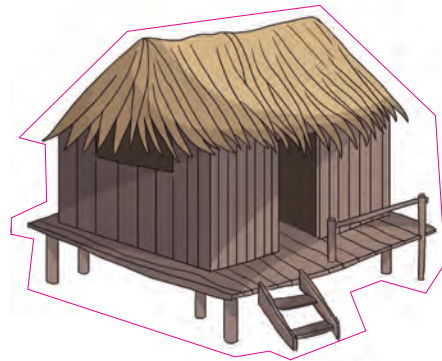
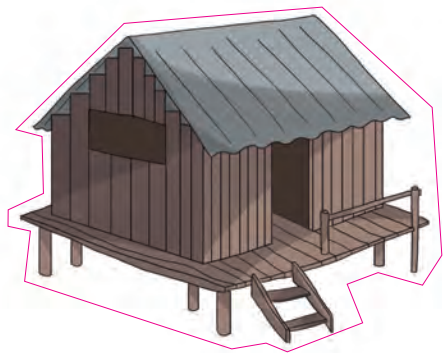

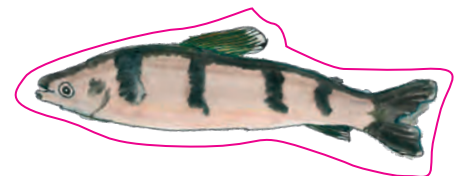
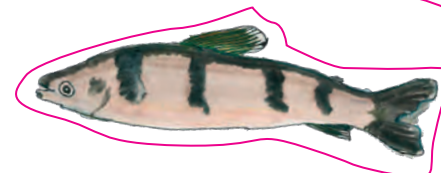
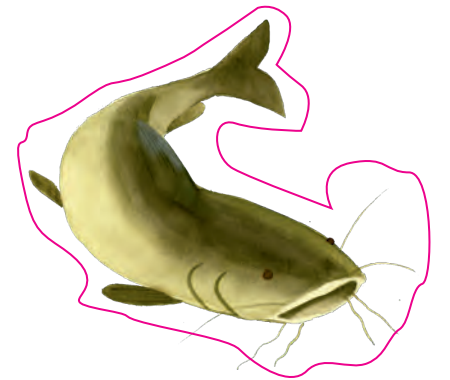
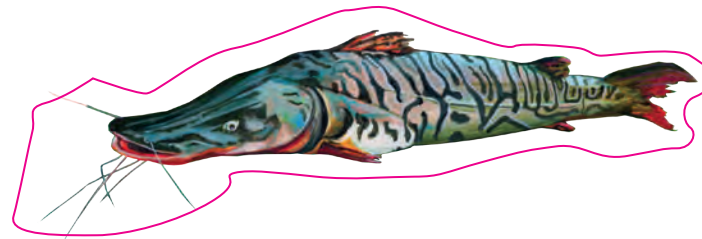
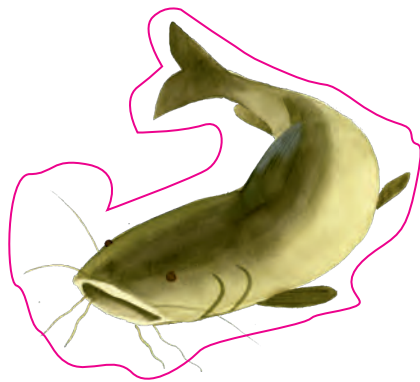
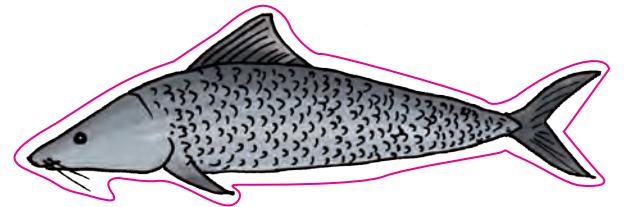
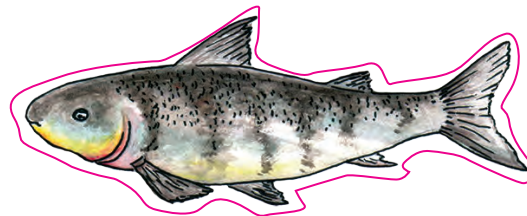
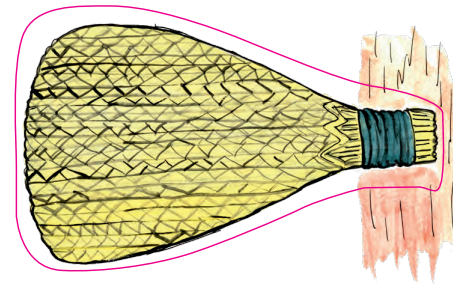
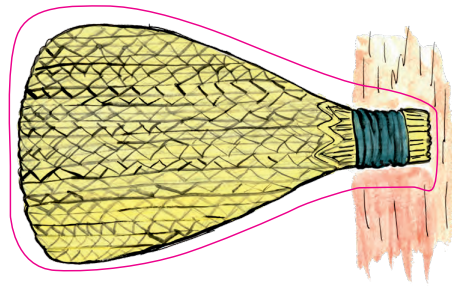
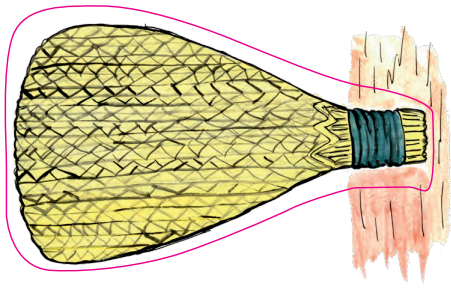

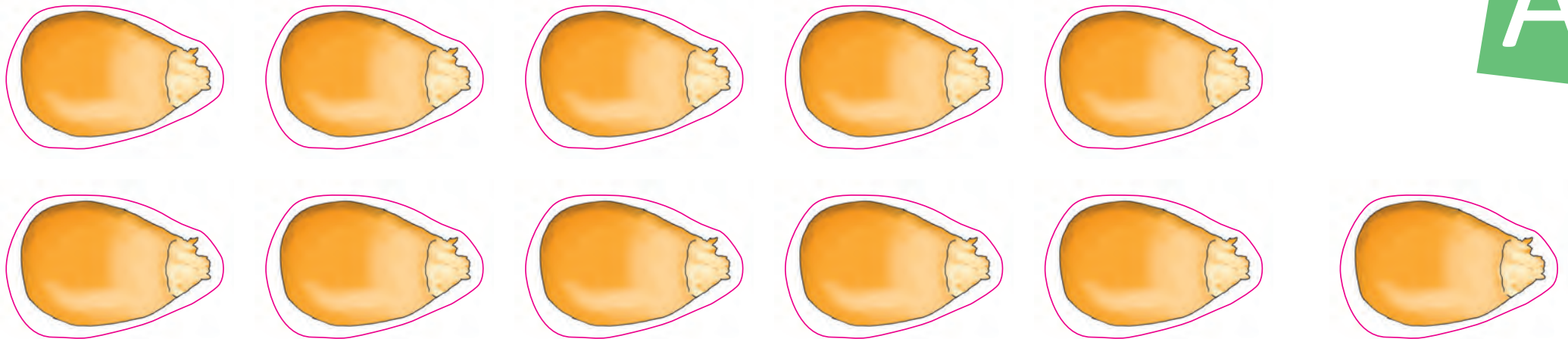

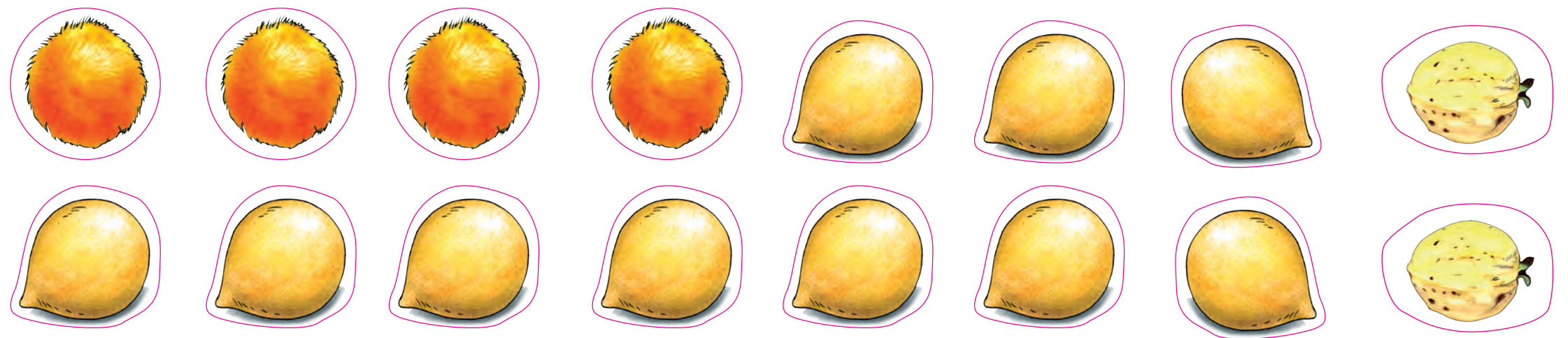
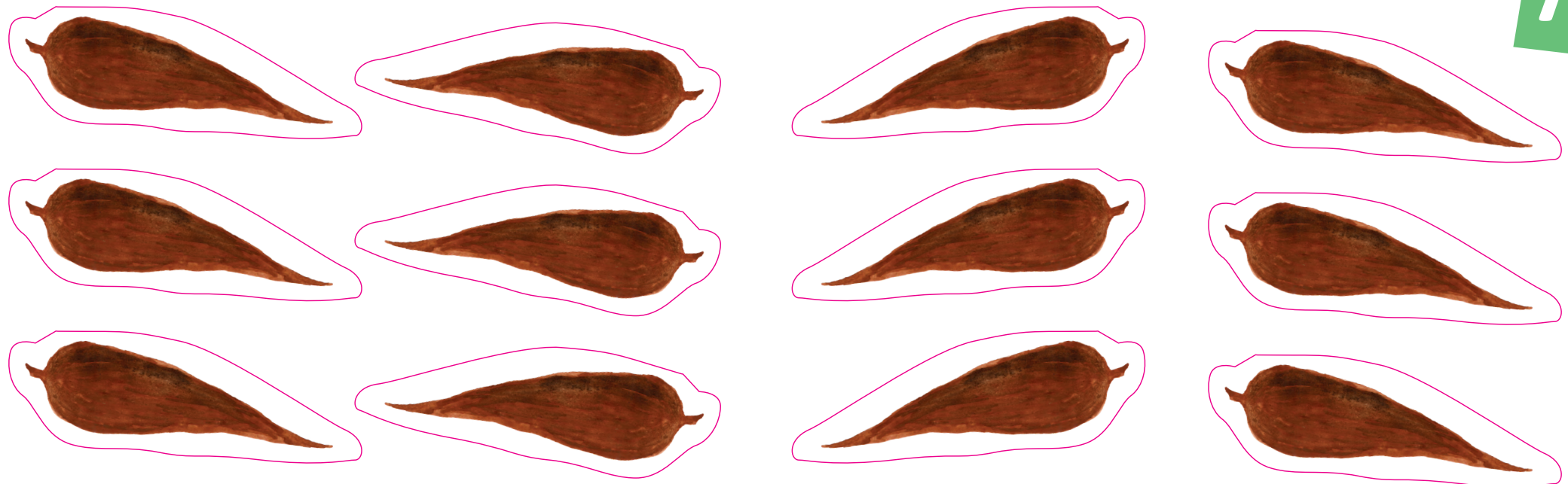

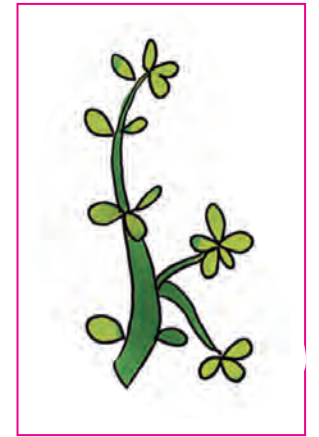
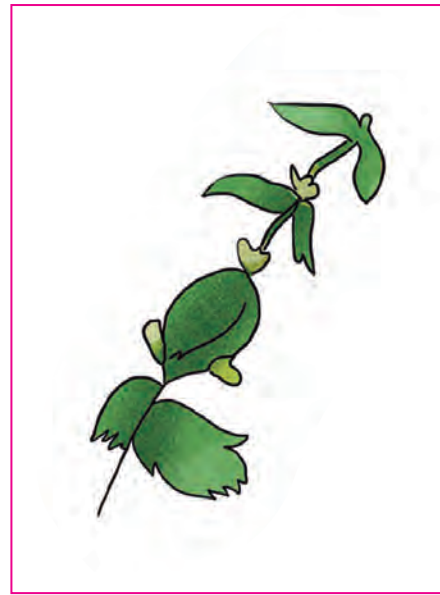
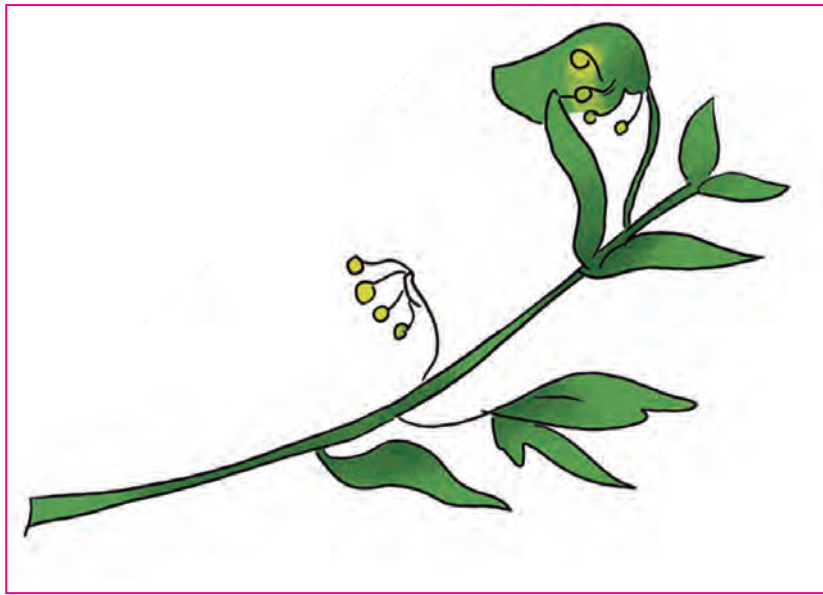



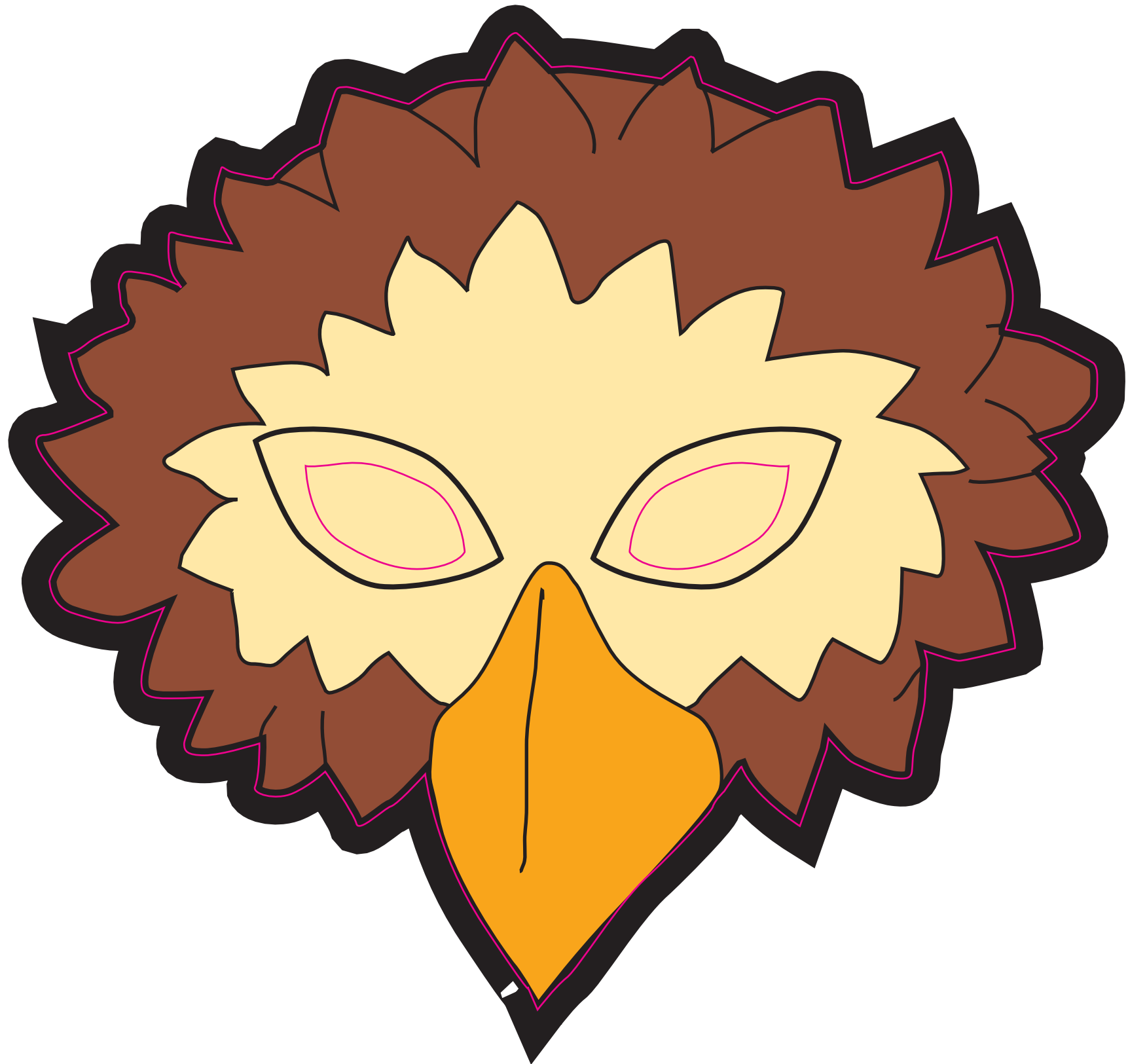

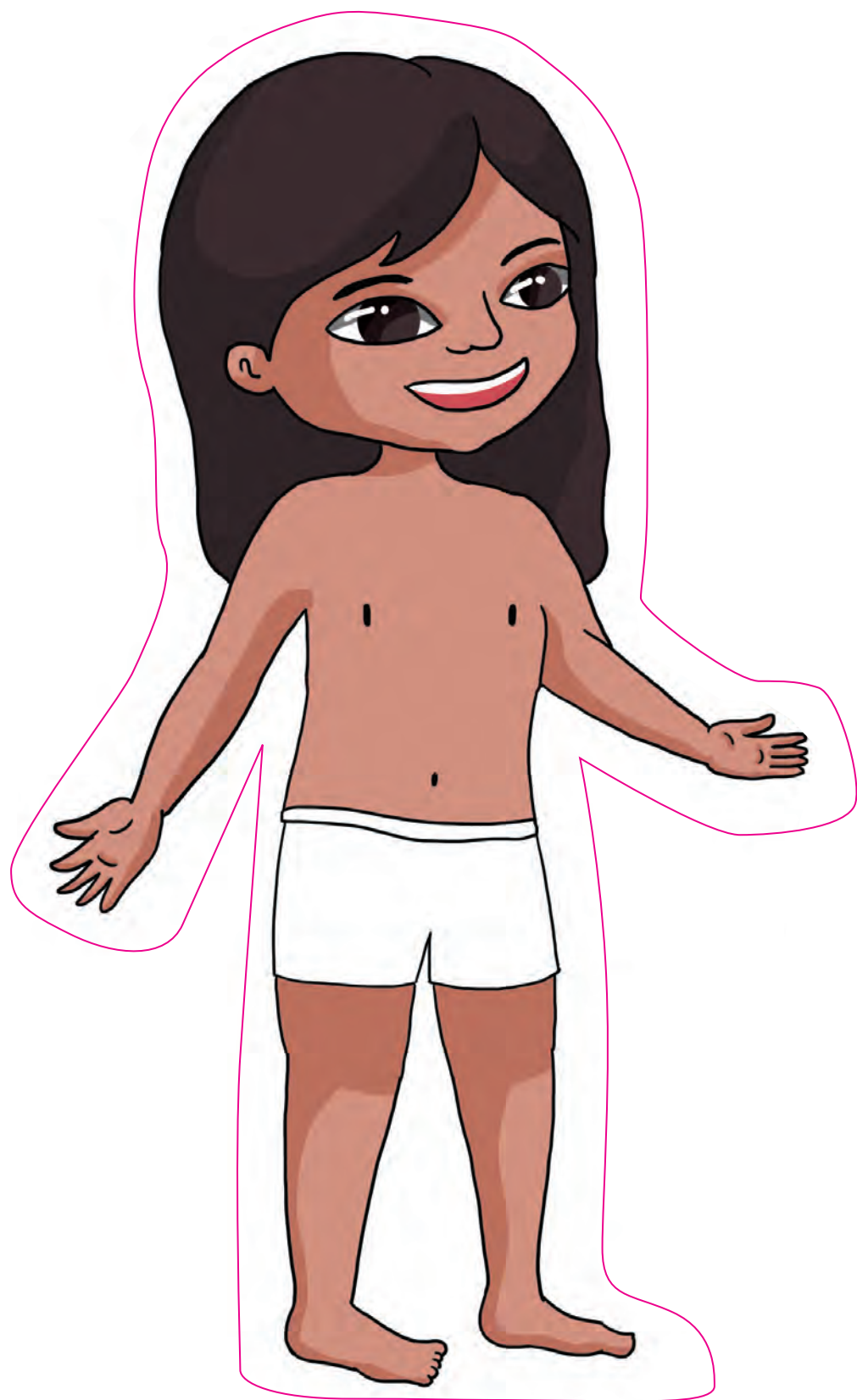

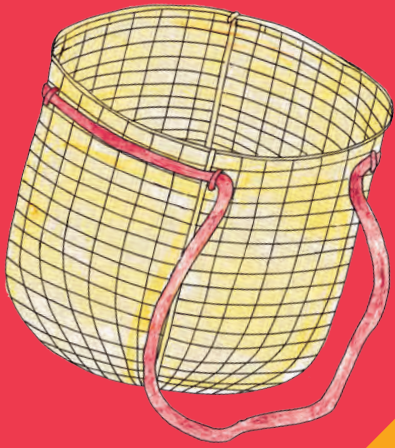

Tsitsan



Pinnu

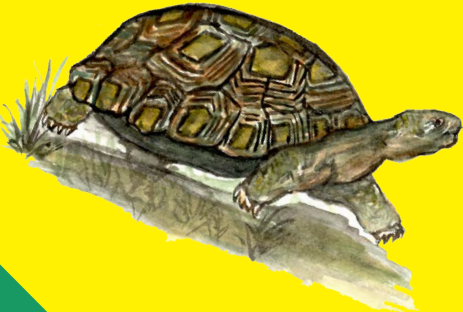

Piush



Dectad



Nuecquid

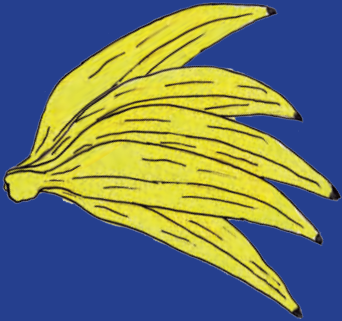

Manni



Genad

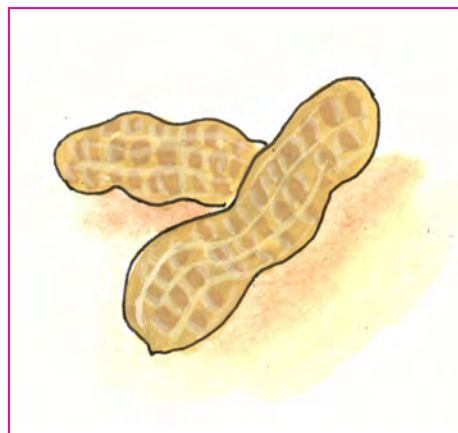
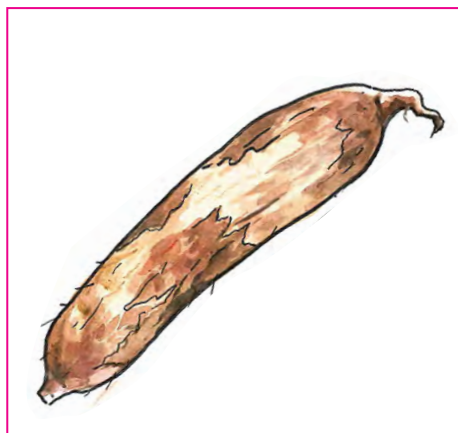
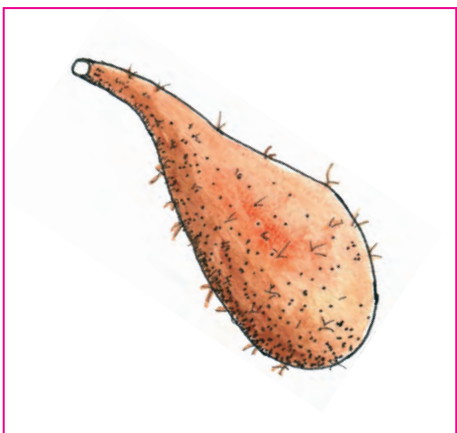
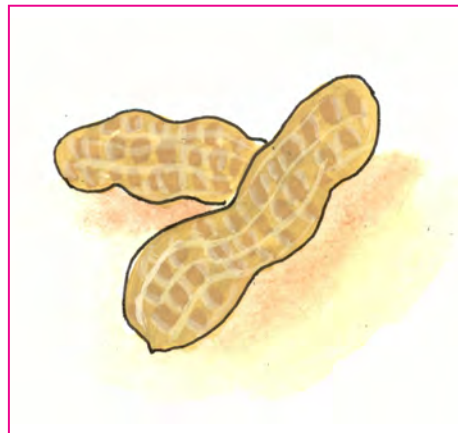
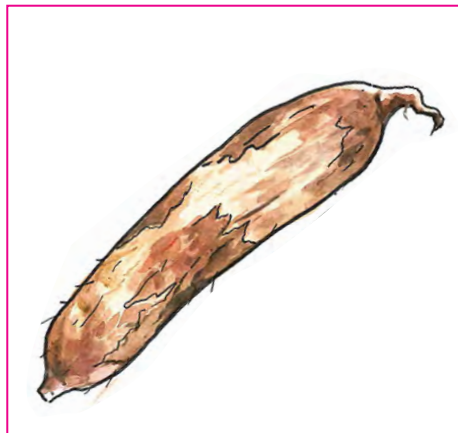
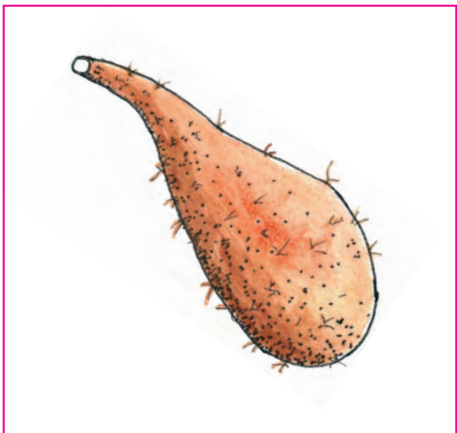

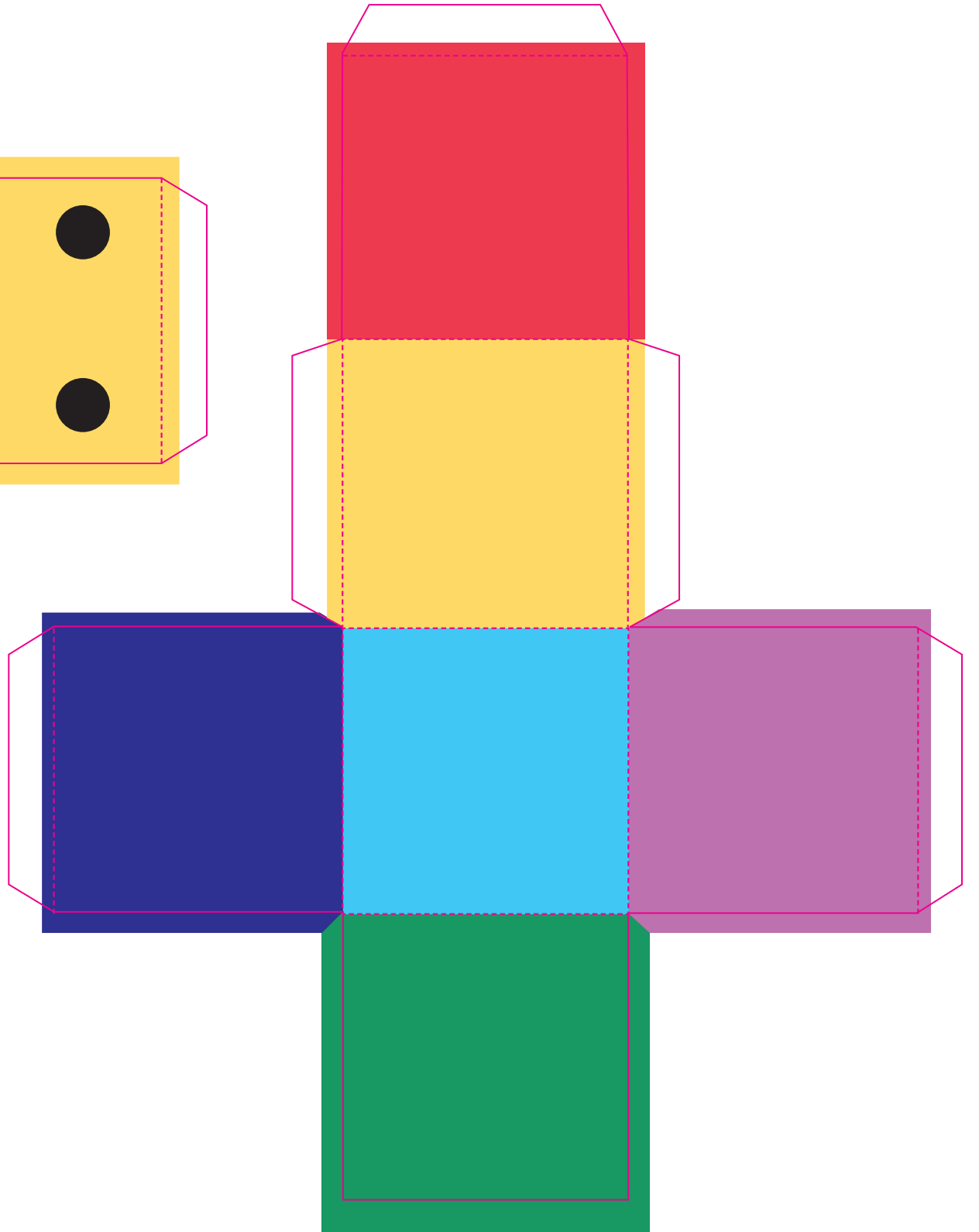
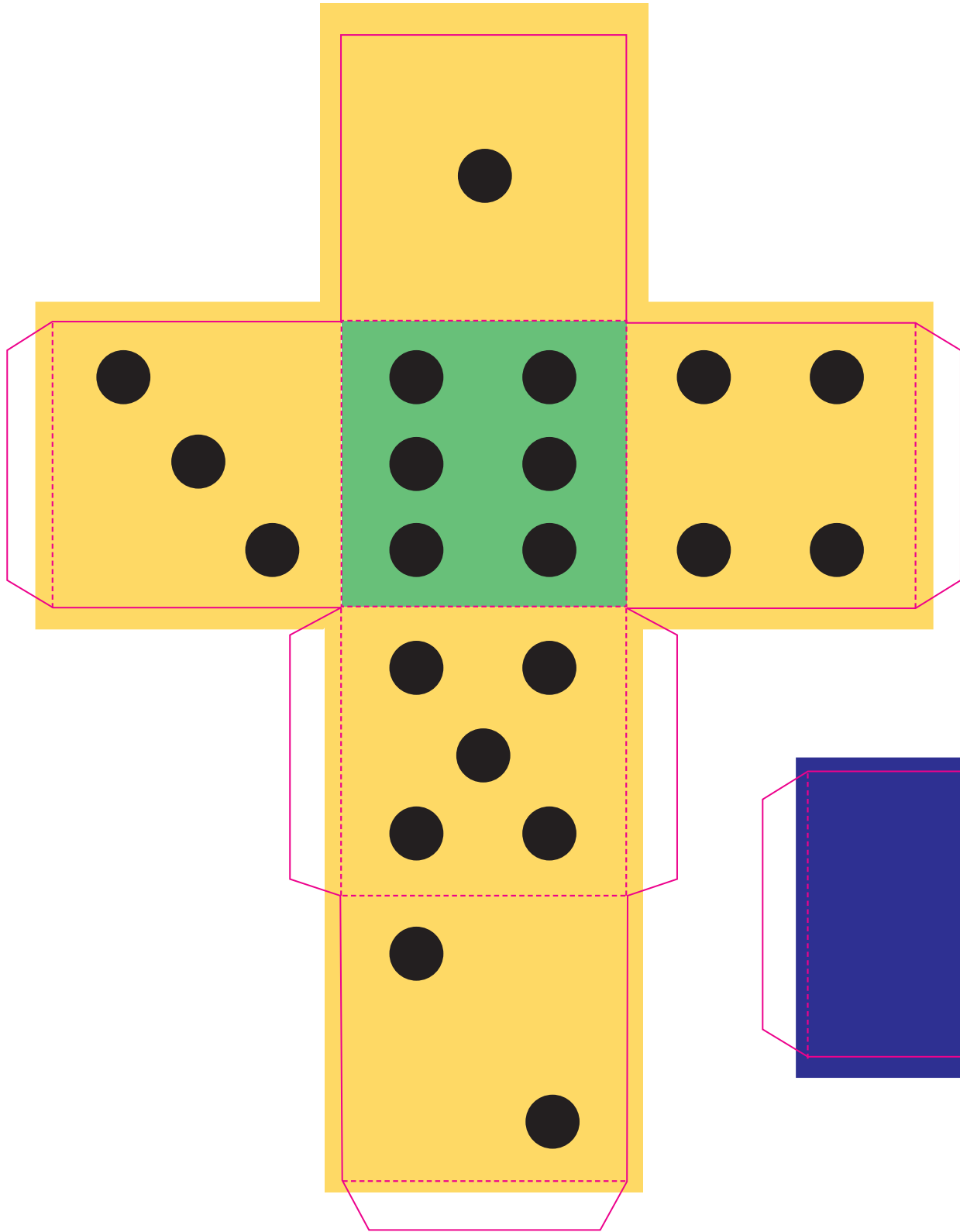

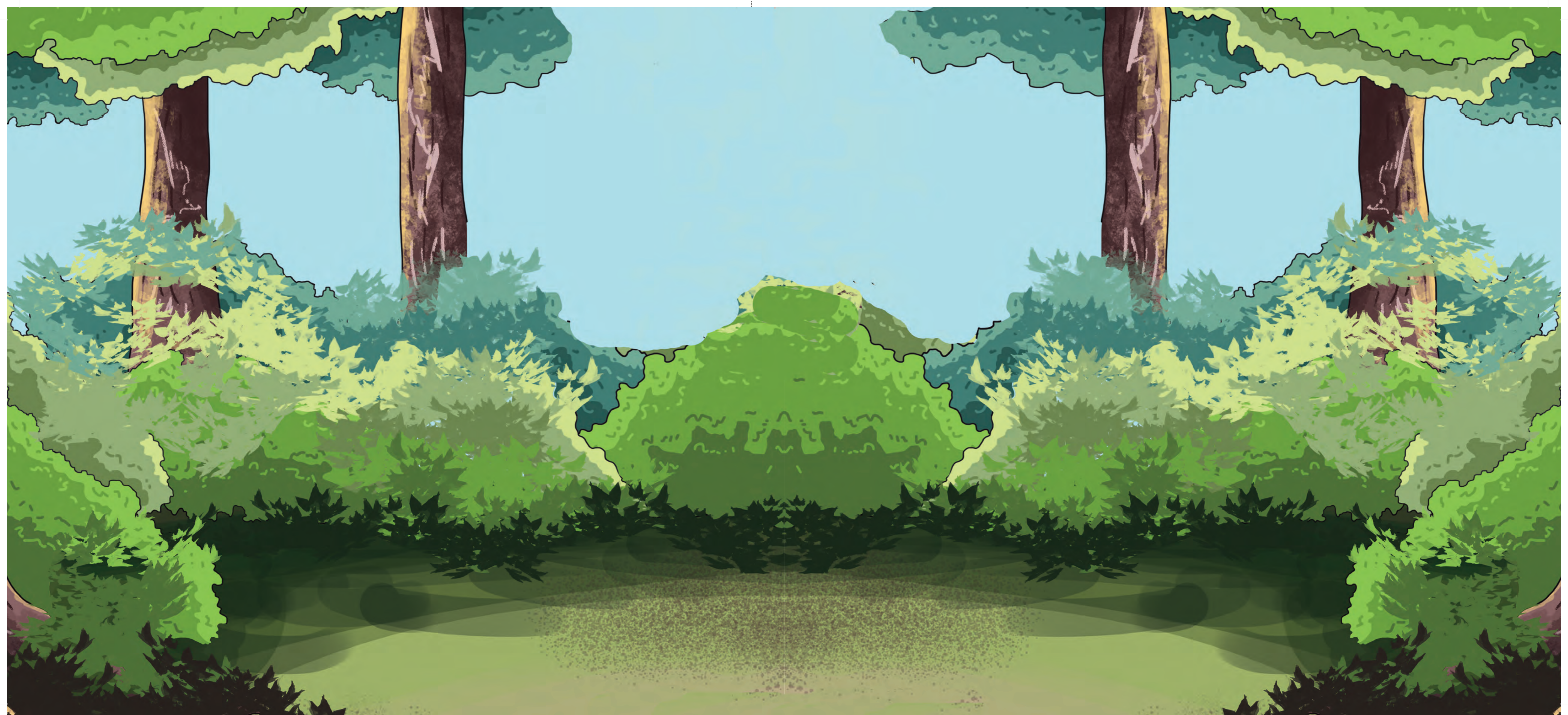

Bacuëbo ismequid chiaid

Umbi tantiado bacuëbo ismequido

Dadauaid bëcadobanquin iste mibi chedo ismenu, aidëmbi ënden chiaid chuibanquin dadauaid iquec, bacuëbon nainquin dadauabante, sauanëmpi icquid chicbanquin bitacabanten nate, dadauate cachoc ënëdacno icquid isbanquin.

Nëid nabanaid ënden chiaid, ma bëdambuec mamënquin tiboquequimbi nanu caid nec. Nuqui yacno icquido chiaidi nec. Ma bacuëbo mibëtambi nabanec, sauanëmpi icquid isbanquin ënden chiadi nabanec anquiadnu caid nec. Nëid ënden chiaid umbi nanu qeshun ambibi naic anquiadec.

Bacuëbo dayacquio icme, ma ambi tantiacpadequi mamënec anquiadnu. Bacuëbon nabante sebadëmbi san, ma ambi bunaidi bednu. Adshun ma ambibi aton mapinshumbi nabanec anquiadnu.

Aton papa chedobi min bacuëbon nacno iseccho cac bëdambo iquec.

Mimbi bëdambuen nauc ca, ambi nabanaid isquin. Adshun ambi tantienquio icaid cueuacquin nashun.

1



Tiquidiuaitdte

2

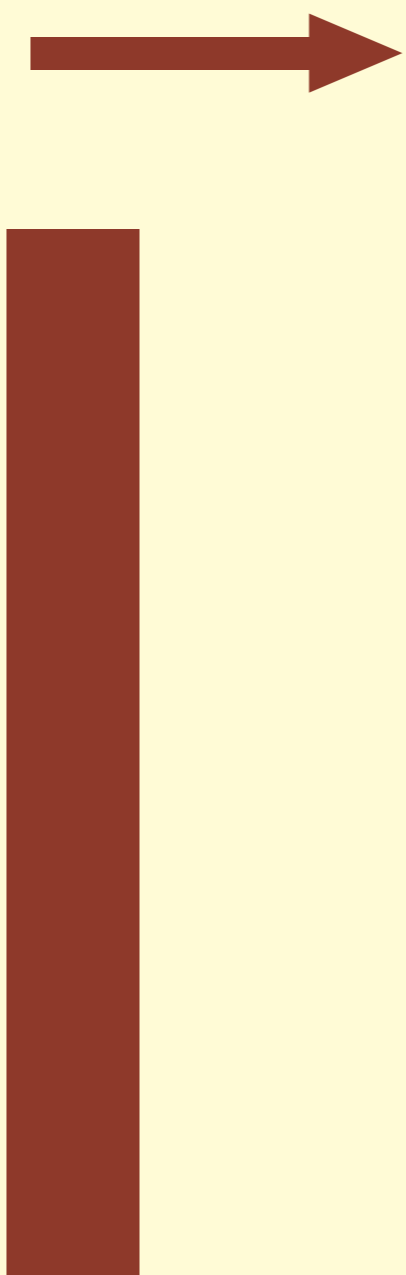

Cuestempite nachennun

3



Tiquidiuaid bidincaic maniën

El Acuerdo Nacional

El 22 de julio de 2002, los representantes de las organizaciones políticas, religiosas, del Gobierno y de la sociedad civil firmaron el compromiso de trabajar, todos, para conseguir el bienestar y desarrollo del país. Este compromiso es el Acuerdo Nacional.

El Acuerdo persigue cuatro objetivos fundamentales. Para alcanzarlos, todos los peruanos de buena voluntad tenemos, desde el lugar que ocupemos o el rol que desempeñemos, el deber y la responsabilidad de decidir, ejecutar, vigilar o defender los compromisos asumidos. Estos son tan importantes que serán respetados como políticas permanentes para el futuro.

Por esta razón, como niños, niñas, adolescentes o adultos, ya sea como estudiantes o trabajadores, debemos promover y fortalecer acciones que garanticen el cumplimiento de esos cuatro objetivos que son los siguientes:

1. Democracia y Estado de Derecho

La justicia, la paz y el desarrollo que necesitamos los peruanos sólo se pueden dar si conseguimos una verdadera democracia. El compromiso del Acuerdo Nacional es garantizar una sociedad en la que los derechos son respetados y los ciudadanos viven seguros y expresan con libertad sus opiniones a partir del diálogo abierto y enriquecedor; decidiendo lo mejor para el país.

2. Equidad y Justicia Social

Para poder construir nuestra democracia, es necesario que cada una de las personas que

conformamos esta sociedad, nos sintamos parte de ella. Con este fin, el Acuerdo promoverá el acceso a las oportunidades económicas, sociales, culturales y políticas. Todos los peruanos tenemos derecho a un empleo digno, a una educación de calidad, a una salud integral, a un lugar para vivir. Así, alcanzaremos el desarrollo pleno.

3. Competitividad del País

Para afianzar la economía, el Acuerdo se compromete a fomentar el espíritu de competitividad en las empresas, es decir, mejorar la calidad de los productos y servicios, asegurar el acceso a la formalización de las pequeñas empresas y sumar esfuerzos para fomentar la colocación de nuestros productos en los mercados internacionales.

4. Estado Eficiente, Transparente y Descentralizado

Es de vital importancia que el Estado cumpla con sus obligaciones de manera eficiente y transparente para ponerse al servicio de todos los peruanos. El Acuerdo se compromete a modernizar la administración pública, desarrollar instrumentos que eliminen la corrupción o el uso indebido del poder. Asimismo, descentralizar el poder y la economía para asegurar que el Estado sirva a todos los peruanos sin excepción. Mediante el Acuerdo Nacional nos comprometemos a desarrollar maneras de controlar el cumplimiento de estas políticas de Estado, a brindar apoyo y difundir constantemente sus acciones a la sociedad en general.

Declaración Universal de los Derechos Humanos

El 10 de diciembre de 1948, la Asamblea General de las Naciones Unidas aprobó y proclamó la Declaración Universal de Derechos Humanos, cuyos artículos figuran a continuación:

Artículo 1.- Todos los seres humanos nacen libres e iguales en dignidad y derechos y (...) deben comportarse fraternalmente los unos con los otros.

Artículo 2.- Toda persona tiene todos los derechos y libertades proclamados en esta Declaración, sin distinción alguna de raza, color, sexo, idioma, religión, opinión política o de cualquier otra índole, origen nacional o social, posición económica, nacimiento o cualquier otra condición. Además, no se hará distinción alguna fundada en la condición política, jurídica o internacional del país o territorio de cuya jurisdicción dependa una persona (...).

Artículo 3.- Todo individuo tiene derecho a la vida, a la libertad y a la seguridad de su persona.

Artículo 4.- Nadie estará sometido a esclavitud ni a servidumbre; la esclavitud y la trata de esclavos están prohibidas en todas sus formas.

Artículo 5.- Nadie será sometido a torturas ni a penas o tratos crueles, inhumanos o degradantes.

Artículo 6.- Todo ser humano tiene derecho, en todas partes, al reconocimiento de su personalidad jurídica.

Artículo 7.- Todos son iguales ante la ley y tienen, sin distinción, derecho a igual protección de la ley. Todos tienen derecho a igual protección contra toda discriminación que infrinja esta Declaración (...).

Artículo 8.- Toda persona tiene derecho a un recurso efectivo, ante los tribunales nacionales competentes, que la ampare contra actos que violen sus derechos fundamentales (...).

Artículo 9.- Nadie podrá ser arbitrariamente detenido, preso ni desterrado.

Artículo 10.- Toda persona tiene derecho, en condiciones de plena igualdad, a ser oída públicamente y con justicia por un tribunal independiente e imparcial, para la determinación de sus derechos y obligaciones o para el examen de cualquier acusación contra ella en materia penal.

Artículo 11.-

1. Toda persona acusada de delito tiene derecho a que se presuma su inocencia mientras no se pruebe su culpabilidad (...).

2. Nadie será condenado por actos u omisiones que en el momento de cometerse no fueron delictivos según el Derecho nacional o internacional. Tampoco se impondrá pena más grave que la aplicable en el momento de la comisión del delito.

Artículo 12.- Nadie será objeto de injerencias arbitrarias en su vida privada, su familia, su domicilio o su correspondencia, ni de ataques a su honra o a su reputación. Toda persona tiene derecho a la protección de la ley contra tales injerencias o ataques.

Artículo 13.-

1. Toda persona tiene derecho a circular libremente y a elegir su residencia en el territorio de un Estado.

2. Toda persona tiene derecho a salir de cualquier país, incluso del propio, y a regresar a su país.

Artículo 14.-

1. En caso de persecución, toda persona tiene derecho a buscar asilo, y a disfrutar de él, en cualquier país.

2. Este derecho no podrá ser invocado contra una acción judicial realmente originada por delitos comunes o por actos opuestos a los propósitos y principios de las Naciones Unidas.

Artículo 15.-

1. Toda persona tiene derecho a una nacionalidad.

2. A nadie se privará arbitrariamente de su nacionalidad ni del derecho a cambiar de nacionalidad.

Artículo 16.-

1. Los hombres y las mujeres, a partir de la edad núbil, tienen derecho, sin restricción alguna por motivos de raza, nacionalidad o religión, a casarse y fundar una familia (...).

2. Sólo mediante libre y pleno consentimiento de los futuros esposos podrá contraerse el matrimonio.

3. La familia es el elemento natural y fundamental de la sociedad y tiene derecho a la protección de la sociedad y del Estado.

Artículo 17.-

1. Toda persona tiene derecho a la propiedad, individual y colectivamente.

2. Nadie será privado arbitrariamente de su propiedad.

Artículo 18.- Toda persona tiene derecho a la libertad de pensamiento, de conciencia y de religión (...).

Artículo 19.- Todo individuo tiene derecho a la libertad de opinión y de expresión (...).

Artículo 20.-

1. Toda persona tiene derecho a la libertad de reunión y de asociación pacíficas.

2. Nadie podrá ser obligado a pertenecer a una asociación.

Artículo 21.-

1. Toda persona tiene derecho a participar en el gobierno de su país, directamente o por medio de representantes libremente escogidos.

2. Toda persona tiene el derecho de acceso, en condiciones de igualdad, a las funciones públicas de su país.

3. La voluntad del pueblo es la base de la autoridad del poder público; esta voluntad se expresará mediante elecciones auténticas que habrán de celebrarse periódicamente, por sufragio universal e igual y por voto secreto u otro procedimiento equivalente que garantice la libertad del voto.

Artículo 22.- Toda persona (...) tiene derecho a la seguridad social, y a obtener (...) habida cuenta de la organización y los recursos de cada Estado, la satisfacción de los derechos económicos, sociales y culturales, indispensables a su dignidad y al libre desarrollo de su personalidad.

Artículo 23.-

1. Toda persona tiene derecho al trabajo, a la libre elección de su trabajo, a condiciones equitativas y satisfactorias de trabajo y a la protección contra el desempleo.

2. Toda persona tiene derecho, sin discriminación alguna, a igual salario por trabajo igual.

3. Toda persona que trabaja tiene derecho a una remuneración equitativa y satisfactoria, que le asegure, así como a su familia, una existencia conforme a la dignidad humana y que será completada, en caso necesario, por cualesquiera otros medios de protección social.

4. Toda persona tiene derecho a fundar sindicatos y a sindicarse para la defensa de sus intereses.

Artículo 24.-

Toda persona tiene derecho al descanso, al disfrute del tiempo libre, a una limitación razonable de la duración del trabajo y a vacaciones periódicas pagadas.

Artículo 25.-

1. Toda persona tiene derecho a un nivel de vida adecuado que le asegure, así como a su familia, la salud y el bienestar, y en especial la alimentación, el vestido, la vivienda, la asistencia médica y los servicios sociales necesarios; tiene asimismo derecho a los seguros en caso de desempleo, enfermedad, invalidez, vejez u otros casos de pérdida de sus medios de subsistencia por circunstancias independientes de su voluntad.

2. La maternidad y la infancia tienen derecho a cuidados y asistencia especiales. Todos los niños, nacidos de matrimonio o fuera de matrimonio, tienen derecho a igual protección social.

Artículo 26.-

1. Toda persona tiene derecho a la educación. La educación debe ser gratuita, al menos en lo concerniente a la instrucción elemental y fundamental. La instrucción elemental será obligatoria. La instrucción técnica y profesional habrá de ser generalizada; el acceso a los estudios superiores será igual para todos, en función de los méritos respectivos.

2. La educación tendrá por objeto el pleno desarrollo de la personalidad humana y el fortalecimiento del respeto a los derechos humanos y a las libertades fundamentales; favorecerá la comprensión, la tolerancia y la amistad entre todas las naciones y todos los grupos étnicos o religiosos; y promoverá el desarrollo de las actividades de las Naciones Unidas para el mantenimiento de la paz.

3. Los padres tendrán derecho preferente a escoger el tipo de educación que habrá de darse a sus hijos.

Artículo 27.-

1. Toda persona tiene derecho a tomar parte libremente en la vida cultural de la comunidad, a gozar de las artes y a participar en el progreso científico y en los beneficios que de él resulten.

2. Toda persona tiene derecho a la protección de los intereses morales y materiales que le correspondan por razón de las producciones científicas, literarias o artísticas de que sea autora.

Artículo 28.- Toda persona tiene derecho a que se establezca un orden social e internacional en el que los derechos y libertades proclamados en esta Declaración se hagan plenamente efectivos.

Artículo 29.-

1. Toda persona tiene deberes respecto a la comunidad (...).

2. En el ejercicio de sus derechos y en el disfrute de sus libertades, toda persona estará solamente sujeta a las limitaciones establecidas por la ley con el único fin de asegurar el reconocimiento y el respeto de los derechos y libertades de los demás, y de satisfacer las justas exigencias de la moral, del orden público y del bienestar general en una sociedad democrática.

3. Estos derechos y libertades no podrán, en ningún caso, ser ejercidos en oposición a los propósitos y principios de las Naciones Unidas.

Artículo 30.- Nada en esta Declaración podrá interpretarse en el sentido de que confiere derecho alguno al Estado, a un grupo o a una persona, para emprender y desarrollar actividades (...) tendientes a la supresión de cualquiera de los derechos y libertades proclamados en esta Declaración.

SÍMBOLOS DE LA PATRIA



BANDERA NACIONAL



HIMNO NACIONAL CORO

Somos libres, seámoslo siempre,
y ante niegue sus luces el Sol,
que faltemos al voto solemne
que la Patria al Eterno elevó.

HIMNO NACIONAL



ESCUDO NACIONAL

DISTRIBUCIÓN GRATUITA
PROHIBIDA SU VENTA