

Aruskipawinaka

Chikpachaki yatiqapxañäni

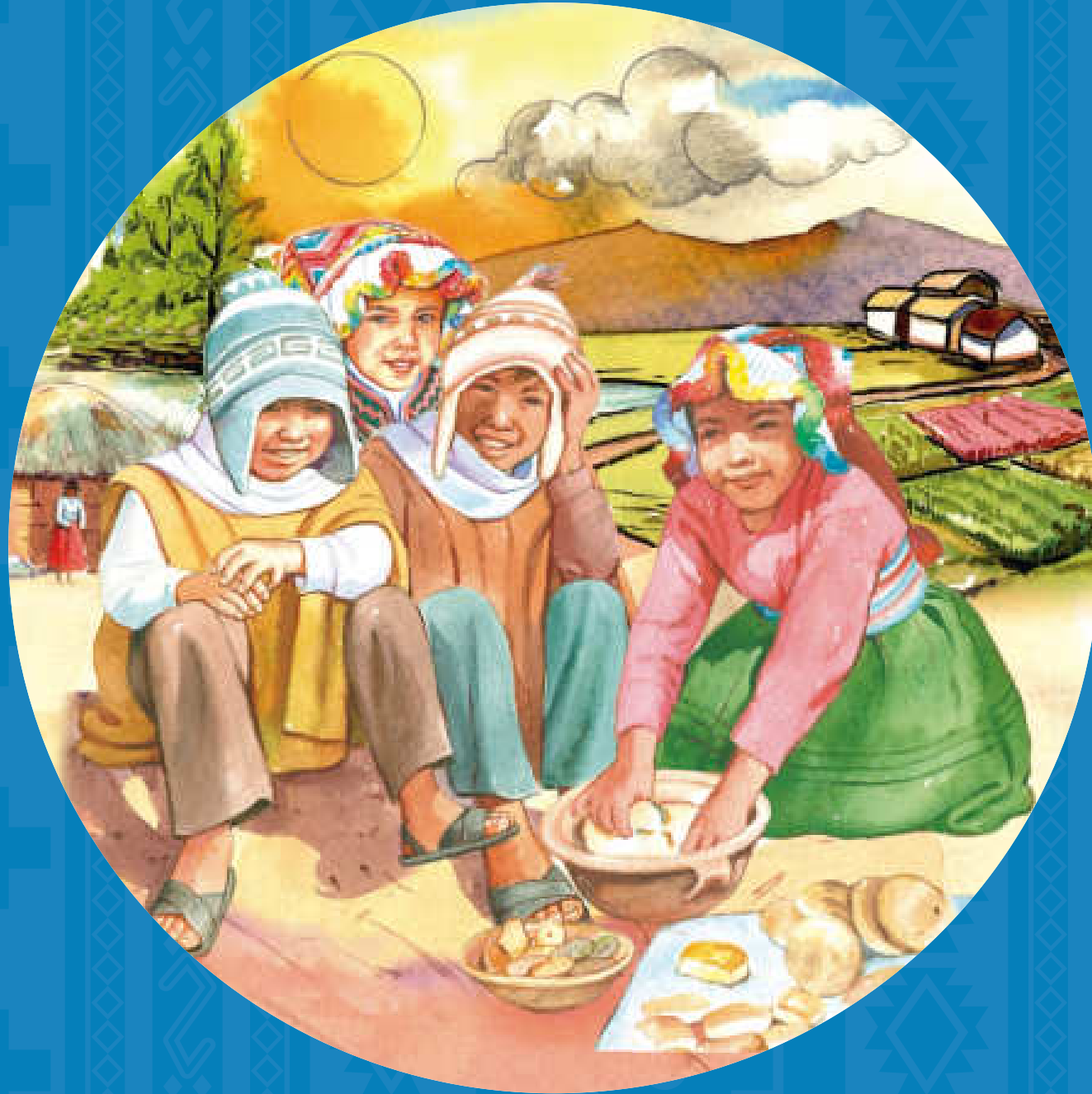

1

Aimara

Comunicación
Cuaderno de Trabajo 1



PERÚ

Ministerio
de Educación

La ciudadana y el ciudadano que queremos



Aruskipawinaka

Chikpachaki yatiqapxañäni

1

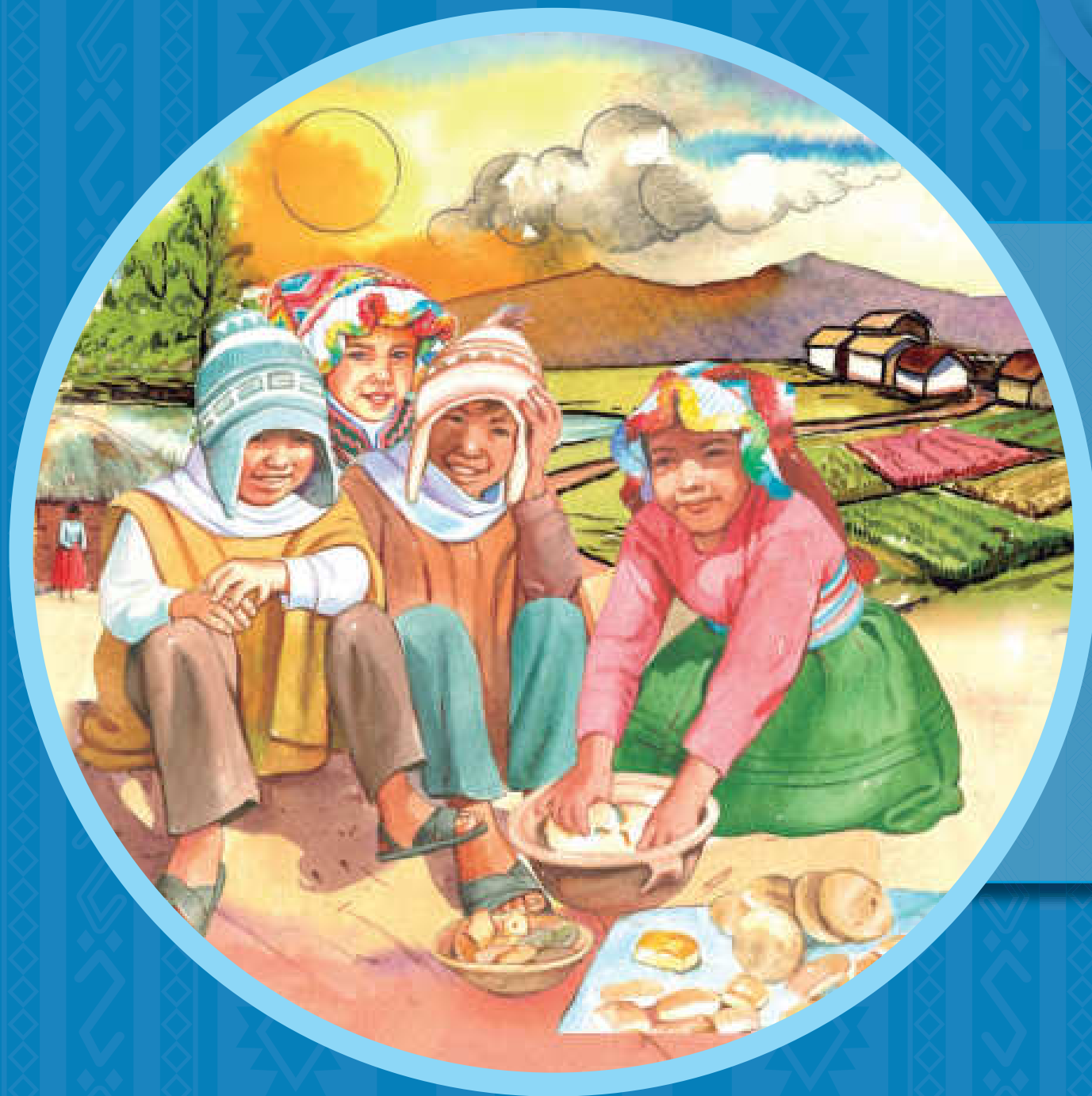

Aimara



Ministerio de Educación

Dirección General de Educación Básica Alternativa, Intercultural Bilingüe
y de Servicios Educativos en el Ámbito Rural
Dirección de Educación Intercultural Bilingüe

1^{ri} Aruskipawinaka - Aimara
Cuaderno de Trabajo - Comunicación 1° - Aimara

©Ministerio de Educación
Av. De la Arqueología cuadra 2, San Borja
Lima, Perú
Teléfono: 615-5800
<https://www.gob.pe/minedu>

Mayiri mirayata
1,823 pankanaka mirayata
Noviembre phaxsina mirayata

Luriri
Yaneth Chipana Pongo

Uñakipaña yanapiri
Edgar Vargas Cayo

Qillqata uñjaña yanapirinaka
Nestor Astete Barrientos, Edgar Vargas Cayo

Chiqaparu luraña yanapiri - Digeibira - DEIB
Abimael Torres Rojas

Suyunakatha yanapasiniri
Octavia Cruz Quenta, Eloy Paxi Cruz

Pankaptayiri
Nylda Ataucuri García

Rixsuri
Carlos Cuadros Oriundo, Archivo Digeibira - DEIB

Mirayawi uñjaña yanapiri
Leoncio Sejje Mamani

Impreso en:
Amauta Impresiones Comerciales S.A.C.,
Jr. Juan Manuel del Mar y Bernedo 1290 - Lima.
RUC N.º 20547416776

Hecho el Depósito Legal en la Biblioteca Nacional del Perú N° 2021-10671
Todos los derechos reservados. Prohibida la reproducción de este libro por cualquier medio,
total o parcialmente, sin permiso expreso de los editores.

Impreso en el Perú/*Printed in Peru*



Nayana yatiyawija

Sutija:

Jichha maraxa:

----- t'aqankthwa

Yatiña utajana jakhuwipa:

Aylluja/markaja:

Yatichirijana sutipa:

Mara: -----

Uñancht'ayata



Suma munata yatiqiri wawa:

Aka yatiqaña pankaxa jumatakiwa. Jupasti yatiña utamana aski yatiqañamataki sumapacha yanapt'antamxa.

Mayaru mathapita yatichiri amawt'anakawa, jumana yatiqasa yatiqasa nayraru sartañamataki suma munasiña chuymampi luranipxtha. Ukaxa yatichirimampi, awki taykamampi, achachilanakamampi ukhamarusa mayniiri wilamasinakamampisa yanapt'ayasisa yatiqañamatakiwa. Yaqhipa lurawinakaxa yatiqiri masinakamampi lurañatakiwa, jumanakpura yanapt'asiñsa chuymachantamwa.

Pankankiri lurawinakasti, markamana yatiwinakapsa lurawinakapsa askipacha yatxatañamataki, ukhamaraki, aymara aru arsuwimsa, qillqawimsa ch'amanchasiñamataki, jakawisana Pachamamarusa, uywirinakasarusa yäqañasatakiwa. Ayllumansa, markamansa, yatiña utamansa, utjawimansa jaqi masinakasampi suma sarnaqaña yanapt'arakitamwa.

Aski k'uchi amuyuniwa akiri pankankirinakampixa anatt'asintasa, warurt'asintasa, saminchantasa, rixsuntasa, uñakipt'asintasa, tupayantasa ukhamawa, sapa mayni t'aqanakana maymaya yatiqawinaka ch'amanchasirakinta. Suma wakisirinaka wakiyawinakampi yatiqantaxa. Aka pankaxa jumana masimjamawa; juparu uñjapunintawa.

¡Suma chuymampi qallantapxañäni! ¡Khusäskaniwa!

Perú markasana yatiña irpirinaka.

Pankankirina uñañchayiripa

1^{ri} T'aqa

Qura qullanakasampi qullasipxañäni



1 ^{ri} Yatiqawi: ¿Kunathsa qura qullanakasaxa pisiki apnaqatäxi?	10	2 ^{ri} Yatiqawi: Qura qullanakampi qullasiñxata yatxatapxañäni	29
1 Laphi: Qura qullanaka apnaqatatha yatxatapxañäni	11	1 Laphi: Qura qullanakatha yatxatapxañäni	30
2 Laphi: Qura qullanaka tuqitha ullapxañäni, ukhamaraki qillqapxañäni	14	2 Laphi: Qura qullanakana wakisitapatha ullapxañäni	33
3 Laphi: Qura qullanaka apthapiña tuqitha ullapxañäni, ukhama qillqapxañäni	18	3 Laphi: Qura qullanaka tuqitha maya jawari ulläsina qillqapxañäni	37
4 Laphi: Yatikipayasipxañäni	22	4 Laphi: Yatikipayasipxañäni	41
5 Laphi: Lurataja uñt'ayaja	25	5 Laphi: Lurataja uñt'ayaja	44
6 Laphi: Milliraya Aylluna qura qullanakampi qullasitapatha yatxatapxañäni	27	6 Laphi: Ñuñuwa ayllunakana ñukch'u apthapiña	46
¡Anatapxañäni!			48

2^{ri} T'aqa

Yapunaka apthapipxañäni

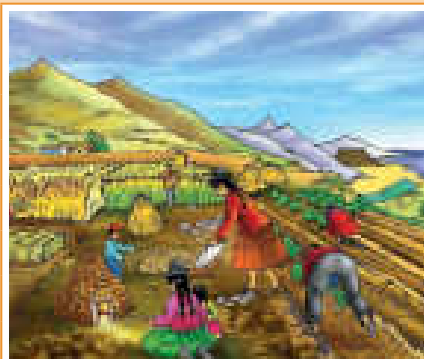

3 ^{ri} Yatiqawi: ¿Kunathsa yapunakaxa pisiki achuqawxi?	50	4 ^{ri} Yatiqawi: ¿Kunathsa yapunakana achuqapaxa juk'akixa?	69
1 Laphi: Yapuna achuqanakapa achuqatapatha yatxatapxañäni	51	1 Laphi: Yapunakaxa achuqatapa jani achuqatapa yatxatapxañäni	70
2 Laphi: Achuqanaka apthapiña tuqitha ullapxañäni ukhamaraki qillqapxañäni	54	2 Laphi: Yapu uywaña tuqitha ullt'apxañäni, qillqt'apxarakiñäni	73
3 Laphi: Ch'uqi llamayñataki yäna tuqitha ullt'apxañäni ukhamasa qillqt'apxarakiñäni	58	3 Laphi: Yapu yäqaña tuqitha ullapxañäni qillqapxarakiñäni	77
4 Laphi: Yatikipasipxañäni	62	4 Laphi: Yatikipasipxañäni	81
5 Laphi: Lurataja uñt'ayaja	65	5 Laphi: Lurataja uñt'ayaja	84
6 Laphi: Ullaraya aylluna llamaywipa unt'apxañäni	67	6 Laphi: Yine jaqinakana chuqupa apsupxi uka tuqitha aruskipt'ma	86
¡Anatapxañäni!			88

3^{ri} T'aqa

Juyphina kamachinakapa



5 ^{ri} Yatiqawi: ¿Kunathsa achunaka aski imasipsnaxa?	90	6 ^{ri} Yatiqawi: ¿Kunathsa mayjt'ayata achunakaxa jani askixi?	109
1 Laphi: Juyphimpi mayjt'ayata achunakatha yatxatapxañäni	91	1 Laphi: Juyphimpi mayjt'ayata manq'anaka juk'akixaspha ukjaxa kamachasphasa uka tuqitha yatthana	110
2 Laphi: Ch'uñuñu kayampitha ullapxañäni, qillqapxarakiñäni	94	2 Laphi: Isañu thayachxata ullt'apxañäni ukatha qillt'apxarakiñäni	113
3 Laphi: Ch'uñu ch'uñuñampitha kaya kayañampitha ullapxañäni, qillqt'apxarakiñäni	98	3 Laphi: Juyphimpi mayjt'ayata manq'anakatha ullapxañäni ukatha qillqapxarakiñäni	117
4 Laphi: Yatikipayasipxañäni	102	4 Laphi: Yatikipayasipxañäni	121
5 Laphi: Lurataja uñt'ayaja	105	5 Laphi: Lurataja uñt'ayaja	124
6 Laphi: Ika markana jaqinakaxa kunjamsa ch'uqi achuqxa mayjt'ayapxapacha imañataki uka tuqitha yatxatapxañäni	107	6 Laphi: Ch'arki luraña tuqitha yatiqthana	126
¡Anatapxañäni!			128

4^{ri} T'aqa

K'umarapxañasataki isinaka wakichapxañäni



7 ^{ri} Yatiqawi: ¿Kunathsa jiwasa p'itata isinakampi jani isisxapxiti?	130	8 ^{ri} Yatiqawi: P'itata isinaka uchasipxañäni	149
1 Laphi: Jiwasa p'itata isinakampi jani isisxatasatha yatxatapxañäni	131	1 Laphi: P'itawisa tuqitha yatxatapxañäni	150
2 Laphi: P'itañanaxata ullapxañäni ukhamaraki qillqapxañäni	134	2 Laphi: Jiwasa p'itañanakasatha ullapxañäni qillqsuxarakiñäni	153
3 Laphi: P'itañanaxata yatiñanaka ullt'apxañäni ukhamaraki qillqt'apxañäni	138	3 Laphi: Wiskha k'anañataki iwaxana ullañäni ukhama qillqsuxaxañäni	157
4 Laphi: Yatikipayasipxañäni	142	4 Laphi: Aruskipapxañäni	161
5 Laphi: Lurataja uñt'ayaja	145	5 Laphi: Lurataja uñt'ayaja	164
6 Laphi: Qhichwanakana p'itatapatha yatxatapxañäni	147	6 Laphi: Shawi aylluna p'itawipatha uñt'apxañäni	166
¡Anatapxañäni!			168

5^{ri} T'aqa

Utachañanakasa



9 ^{ri} Yatiqawi: ¿Kunjamäskisa ayni mink'a ukanakaxa uta utachañanxa?	170	10 ^{ri} Yatiqawi: Uta utachaña yanapt'asipxañäni	189
1 Laphi: Utachkasaxa kunathsa juk'aki aynisitaxi mink'asitaxi ukxata yatxatapxañäni	171	1 Laphi: Kunjamsa utachaña yanapt'asifataki aynimpi mink'ampi ch'amañchapxirixnaxa	190
2 Laphi: Uta utachañataki munasiri yänakatha ulläsina qillqapxañäni	174	2 Laphi: Uta utachaña yänakatha ullapxañäni	193
3 Laphi: Utachaña yänakxata ullapxañäni qillqapxañäni	178	3 Laphi: Maya wakiyata apthapinaka ulläsina qillqapxañäni (catálogo)	197
4 Laphi: Yatikipayasipxañäni	182	4 Laphi: Yatikipayasipxañäni	201
5 Laphi: Lurataja uñt'ayaja	185	5 Laphi: Lurataja uñt'ayaja	204
6 Laphi: Ch'umi suyuna utachasiwinakapatha yatxatapxañäni	187	6 Laphi: Shawinakana uta utachasinakapa uñt'apthana	206
¡Anatañäni!			
		208	

6^{ri} T'aqa

Uywanaka uywachapxañäni



11 ^{ri} Yatiqawi: ¿Kunjamäskisa ayllusana uywanaka uywachañaxa?	210	12 ^{ri} Yatiqawi: ¿Uywanakasaxa kunathpunisa pisikixisti?	229
1 Laphi: Kunathsa pisiki uywa uywachapxi uka yatxatañäni	211	1 Laphi: Uywanakaxa kunanakathsa pisikixi uka tuqitha yatxatapxañäni	230
2 Laphi: Uywa uywaña yatiyawinakatha ullapxañäni ukhamasa qillqapxañäni	214	2 Laphi: Ullapxañäni, ukatha yatiyawini laphinaka qillqapxañäni	233
3 Laphi: Maya jiskht'awitha ullapxañäni ukhamasa qillqsuxpañäni	218	3 Laphi: Ullapxañäni, ukatha mä yatiyawini qillqsuxpañäni	237
4 Laphi: Yatikipayasipxañäni	222	4 Laphi: Aruskipapxañäni	241
5 Laphi: Lurataja uñt'ayaja	225	5 Laphi: Lurataja uñt'ayaja	244
6 Laphi: Shawi aylluna chakuwipatha katuña	227	6 Laphi: Ashaninka uka markana uywa katuña	246
¡Anatañäni!			
		248	

7^{ri} T'aqa

Satawina suma qamarapxañäni



13 ^{ri} Yatiqawi: ¿Kunjama satatäskisa yapunakasaxa?	250	14 ^{ri} Yatiqawi: Yapunakasana satañxata yatxatapxañäni	268
1 Laphi: Yapunakasaru kunjamsa sataxipkthana uka tuqitha yatxatapxañäni	251	1 Laphi: Sataña pachana wakisirinakatha yatxatapxañäni	270
2 Laphi: Sataña tuqitha mä karta ullapxañäni ukhama qillqsuxpañäni	254	2 Laphi: Maya correo electrónico uka ullapxañäni ukhama qillqapxañäni	273
3 Laphi: Maya jaysawi karta ullapxañäni ukhama qillqsuxpañäni	258	3 Laphi: Satañxata yatiyawini qillqata ullapxañäni, ukhama qillqsuxpañäni	277
4 Laphi: Yatikipayasipxañäni	262	4 Laphi: Yatikipayasipxañäni	281
5 Laphi: Lurataja uñt'ayaja	265	5 Laphi: Lurataja uñañcht'ayaja	284
6 Laphi: Yaqha ayllunakana satañanakapa tuqitha yatxatapxañäni	267	6 Laphi: Qanchis Aylluna satañapa tuqitha yatxatapxañäni	286
¡Anatañäni!			
		288	

8^{ri} T'aqa

Taqinimpisa sumaki jakasipxañäni

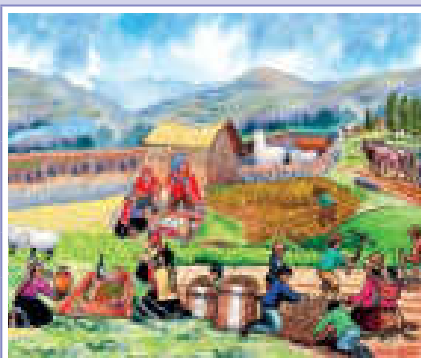

15 ^{ri} Yatiqawi: ¿Kunjamsa suma jakawi wilamasisa taypina ch'amañchasipxsnaxa?	290	16 ^{ri} Yatiqawi: ¿Kunathsa wilamasisa taypina jani suma jakawixa utjpacha?	309
1 Laphi: Kunathsa jiwasa taypina jani wali sarnaqawixa utji, ukxata yatxatapxañäni	291	1 Laphi: Suma jakaña tuqitha yatxatapxañäni	310
2 Laphi: Maya amta jawari ullt'apxañäni ukatha qillqapxarakixäni	294	2 Laphi: Amtanakasa ullt'apxañäni ukhama qillqsuxpañäni	313
3 Laphi: Nayra sarawitha ullapxañäni, qillqapxarakixäni	298	3 Laphi: Maya amta qillqa ullapxañäni ukhamasa qillqapxañäni	317
4 Laphi: Yatikipayasipxañäni	302	4 Laphi: Aruskipapxañäni	321
5 Laphi: Lurataja uñt'ayaja	305	5 Laphi: Lurataja uñt'ayaja	324
6 Laphi: Shipibo-Konibo ayllunakana jakawinakapatha yatxatapxañäni	307	6 Laphi: Perú suyuna jach'a larama quta thiyana jakasipxatapatha uñt'apxañäni	326
¡Anatañäni!			
		328	

1ri

Qura qullanakasampi
qullasipxañäni

T'aqa



¿Kunathsa qura qullanakasaxa pisiki apnaqatäxi?



Aski wakisiri utjirinaka:

Usuntawsina aka pachanakana jaqinakaxa suma k'umara jakasiñatakixa pampankiri qura qullanakampi qullasiñxa yaqhipanaxa janikiwa yäqxapxiti.

Pharmaku qullanakampikiwa qullasiñaru waytasxapxi, ukxa chaniru jani chaniruwa umxapxaraki.

Uñxatma, ukatha kutt'ayma:

1. ¿Kunsa jamuqankiri jaqinakaxa lurasipki?
2. ¿Askipachati pharmaku qullanakampi qullasiñaxa? ¿Kunathsa?



Ch'amt'añasa:

¿Kamachapsnasa qulla quranakampi qullasisa aski k'umara jakañataki yatxatañatakixa?

Lursuña: Qura qullampi qullasiñxata sixsma, ukatha yatiyma.

Qura qullanaka apnaqatatha yatxatapxañäni

1 Laphi



Yatiqañataki wakichasipxañäni

1. Mayninakampi aruskipma.

¿Kunjamsa qura qullampi qullasiñaxa?



Jichha pachanxa, pisikwa qura qullampi qullasipxixa.

Askipacha yatxatapxañäni

2. Qura qullanaka tuqitha ullapxañäni.



Ayllujana qura qullanakapa



Juliku achachilaxa Intimpi Urpimpi allchhinakapampi simana santana phuqata qura qullanaka apthapiriwa sarapxäna, wali k'uchiwa akhama qullanaka amthapiri: misik'u, salwiya, nawusa, wirawira, waych'a, piliruna, ukhamanaka.

Purisinxa, janiwa kuna qullsa jakipxataynati, qurpapana utjasirinakawa uwijampi awatsxapxatayna. Ukatha achachilaxa satayna: “**Jichha jaqinakaxa janikiwa qura qullanaka yäqañsa amtxapxiti!**, janirakiwa qura qullanakampisa qullasxapxiti, pastillanakakwa chani jani chani umasipki”, sasa.

3. Arsuwimpi jiskt'awinakaruru jaysama.

- ¿Kunathsa Juliku achachilasti allchhinakapampi k'uchipxänsti?
- ¿Jaqinakaxa kunathsa qura qullanaka janiki apthapxapxisti?
- ¿Kunathsa qura qullanasakaxa jani aski apnaqatäxpacha?

4. Chiqapa kutt'ayawi maya (X) chimpuntma.

- ¿Jani qura qullanaka pachaparu apthapipksna ukjaxa kamachasphasa?

Jani qullaniwa uñjasnaxa.

Jani manq'aniwa uñjasnaxa.

- ¿Kunatakisa qura qullanaka apthapiñaxa wakisi?

Qullasiñataki.

Manq'añasataki.

5. Wilamasimampi k'umaräñataki kunathsa qura qullanakaxa pisiki apnaqatäxi, uka tuqitha aruskipma, ukatha sixsurakma.



6. Wilamasimaxa kunfi qura qullanakasa pisi apnaqatatha yatiyktama, uka sixsma ukatha qillqarakma.

Handwriting practice area with three horizontal dashed lines.



7. Yatiqawi utana qillqatama ukhamasa sixsutama yatikipayma.

Yatiqatasatha amuykipapxañäni.

8. Ayllumana utjiri qura qullananka samichma.

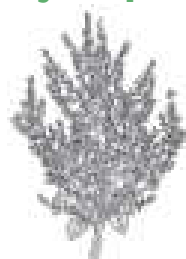

muña



atapallu

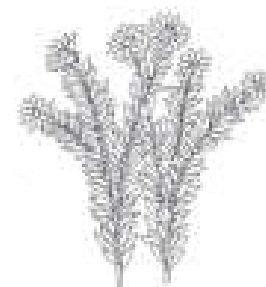

misik'u

9. Jiskht'anaka ullma, ukatha kutt'ayawima samichma.
¿Wakisiriti qura qullanaka yäqañä ukhama apthapiñaxa?

Jisa

Janiwa

• ¿Kunathsa?
Handwriting practice area with a horizontal dashed line.



2 Laphi

Qura qullanaka tuqitha ullapxañäni, ukhamaraki qillqapxañäni

Yatiqañataki wakichasipxañäni

Janira qillqata ullkasa, jaysma.

Qura qullanakana wakisitapa janiwa aski yatxthanti, ukathwa pisiki apnaqthanxa.



Qura qullanaka uñt'añasawa, ukampinsa yäqañasawa.

Askipacha yatxatapxañäni

1. Laphillankiri jamuqana sutipa ist'ma, ukatha jamuqana **"Ayrampu"** sutina qallta qillqapa kikipa sallaniki ukaru muyuntayma.



2. Akiri "Ayllujana qura qullanakapa" qillqatana "Inti" suti ist'äsina uka kikipa sallaniki tukuyaru maya (X) chimpuntma.

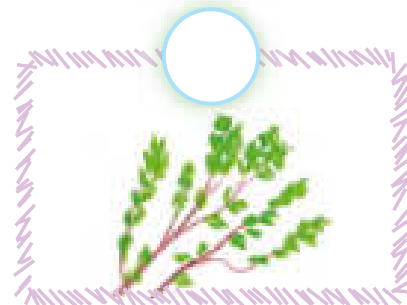
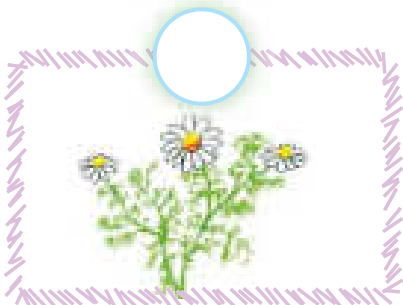

3. Jamuqanakana sutipa ullma, ukatha sapa salla arsüsina mä t'axllimpi chikjma.



muña



matiku



atapallu

4. Arunakana sutinakapa ist'ma, ukatha sapanqata salla arsuri ist'äsina thuqtma. Ukathxa qhawqha thuqtawisa utji, uka jakhu uchma.



muña

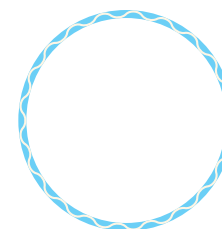

matiku

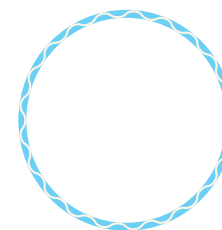

atapallu

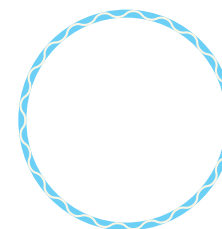

5. Nayra sayt'unkiri uka kipka qillqanaka jakiñaru anapaxañäni.



Maya
chimpumpi (X)
sich'intma.

q	q	p	b	p	a
m	n	m	м	w	M
p	p	p	g	p	q
k	f	k	x	k	h
s	e	s	c	&	z
u	n	u	h	u	n
h	h	u	n	h	μ

6. Akiri wakichatana samichäsina, qura qullanakana sutinakapa jakiñaru anatapxañäni.

ma12345	laqatu	matiku
pi Σ^{∞} ma	Ω ot Σ	misik'u
rura	muña	P1m2
q	uwj Ω 9	atapallu

7. Akiri wakichatana, kawkiri amuyunakati k'umaräña tuqi yatiyki, ukaru maya (X) chimpuntma.

Wawanakaxa qura qullanaka apthapipxi.	
Inti wawaxa wali k'uchi uwijanaka awatiski.	
Muña qura qullaxa puraka usutakiwa khusaxa.	
Achachilajaxa alinakarum suma jakayañatakiwa uma wayuski.	
Mamajaxa matikuni junt'u umwa umaskixa.	



3 Laphi

Qura qullanaka apthapiña tuqitha ullapxañäni, ukhama qillqapxañäni

Yatiqañataki wakichasipxañäni

¡Qura qullanaka apthapiri sarañäni!



¿Kuna qura qullanaksa apthapiniñänixa?

Askipacha yatxatapxañäni

1. Qillqata janira ulläsina, kutt'ayma:

¿Qura qullanakaxa kuna pachansa apthapiñäpachaxa?

¿Qillqataxa kuna tuqithsa yatiypachistani?

2. Qillqata ch'ujuki ullma, ukatha uñ'ta arunakaru muyuntayma.

Apu Qhapiya qura qullaniwja

Luwisa awichajaxa kunaymana qura qullanaka apthapiñwa yatichapxitu, jisnawa: ayrampu, misik'u, panti panti, chhijchhipa, muña, llantina, salwiya ukhamarusa yaqhanakampi.

Apu Qhapiya uka chiqanxa, janira Willka tata qhantankiphana wawanakaxa awichana yatichataparjamawa qura qullanaka apthapiri sarapxäna.

Ukathxa, awichaxa thaya usutaki, ch'uxu usumpitaki qura qullanakxata yatiyäna.



3. “Apu Qhapiya qura qullaniwja”, uka qillqata janira ullkasa, arsuwimpi kutt’ayma:

- ¿Kunatakisa qura qullanakaxa apthapiñasti? ¿Kawkiri qura qullanakasa apthapiñasti?
- ¿Kuna usunaksa qullasisphasti? ¿Uka Apuxa kuna sutinisa?



¡Qura qullanakana
sutinakapampi
anatapxañäni!

4. Arunaka ist’ma, ukatha jamuqanakana qhipa sallapa kikiparu tukuyki ukirinaka mä riximpi tupayma.



Yatiqiri masinakamaru luratama
uñachayma, ukatha kunjamsa
lurta uka yatiyma.

Jichhaxa
katjawinaka ulläsina
k'uchirt'asipxañäni.



5. Katjawi ullapxañäni ukatha kutt'ayawipa sixsuñäni.



Qulliri sasa uñt'atäthwa,
Ch'uxña isini qullirithwa,
Ch'uxña laphi isini,
qulliriskapunthwa,
ch'uxu usu qullirithwa,
¿Khitipachäthsa?

ullapata

utpilakwi

Jani khitinsa llamkt'aña imilla
wawäthwa, llamkt'ataxa
usuchiriksmawa,
thaya usu qullirithwa.
¿Khitipachäthsa?

Jichhaxa katjawinaka
qillqapxañäni.



6. Arsuwimpi jaysapxañäni:

- ¿Kawkiri qura qullanaksa utana uywasnaxa?
- ¿Katjawi qillqañataki kunasa wakisi yatiñajasti? Kutt'ayma.

¿Kunsa qillqajasti?

¿Kunatakisa qillqajasti?

¿Khititakisa qillqajasti?

7. Utana uywasita qura qulla tuqitha mä katjawi qillqasma, ukatha sixsma.

Four horizontal dashed lines for writing on the left, and a yellow rounded rectangle with a pencil icon on the right, representing a writing area.

Wilamasimaru katjawi
qillqatama yatiyma,
ukatha taqi kuna
katjawi yatitanakapa
yatichayasma.

Yatiqatasatha amuykipapxañäni

8. Kutt'ayma:

- ¿Kawkiri qura qullanakayrisa utana uywasnaxa?
- ¿Uka qura qullaxa kuna usunaksa qullixa? ¿Kunathsa?





4 Laphi

Yatikipayasipxañäni

Yatiqañataki wakichasipxañäni

1. Yatiqiri masinakasampi sixsuta uñxatañäni, ukatha aruskipapxañäni.

- ¿Wawanakaxa kunapachasa qura qulla apthapiri sarapxäna?
- ¿Kunathsa ch'aphi alinakaxa utwjana uywasiñäpacha?



Askipacha yatxatapxañäni

2. Yatichirimampi ch'aphi alinakaxa utawjana kunathsa uywasiñäpacha uka yatiwinaka tuqitha aruskipma, ukatha yatiqatama sixsma.





Ch'apinakaxa
utawjaru uywasiñawa,
kuna ñanqhanakasa
ukarukiwa puriskirixa.



3. ¡Yatiqiri masinakamampi warurt'a ist'ma, ukatha mayiri t'aqa warurt'ma!

Qura qullasa warurt'a - satiri wirsu

Qura qullanaka apthapiñasawa. (kuti)
Qullasiñataki, k'umarañataki,
k'uchikiñataki jakañatakisa.
La la la la lay.



4. Wakichasipxañäni, ukatha warurt'askakiñataki amuyuñäni.

- Warurt'awina qillqata arunakapa amtañäni.
- Uka warurt'awi t'axllimpi yanapt'asisa yant'apxañäni.
- Warurt'aña yanapt'ayasiñataki yänaka lurapxañäni.

Wilamasimampi
yaqha warurt'a
yatichayasma.



5. Janira warurt'käsina, warurt'awina uñnaqapa rixsma.



- Warurt'a t'axllinakampi ukhama kuna yänakampisa warurt'ma.
- Jumaru wakt'ätama uka suyma.



- Yatiqiri masinakamana warurt'awinakapa ist'ma, ukatha warurt'ma.
- Iwxapa qhanapacha jisma.

Yatiqatasatha amuykipapxañäni

6. Yatiqiri masinakararu ist'awsina ukhama warurt'awsina, warurt'awi tuqitha aruskipma.

7. Warurt'awina iwxapa rixsuñäni.



Yatiqañataki wakichasipxañäni

1. Mayninakampi aruskipma.

¿Yatiqiri masinakamaru kunathsa qura qullanakaxa pisi yäqxapxi, uka tuqitha sasmati?



¡Qura qullanakaxa kunathsa jani aski apnaqatäxi, ukatha aruskipañaxa aski wakisiriwa!

Askipacha yatxatapxañäni

2. Janira jiskht'äsina, qura qullanakaxa kunathsa pisi yäqatakixi, uka sixsma.



3. Jichhaxa, qura qullanakaxa kunathsa pisi yäqatakixi, uka qillqasma.

4. Qillqsutamatha sixsutamampitha yatiqiri masinakamaru ukhamarusa wilamasimaru qura qullanakaxa kunathsa pisiki yäqataxi, uka tuqitha jisma.

Nayana ayllujana qura qullampi qullasisipkiwa.



Nayatakixa, qura qullaxa pisi yäqatakipuniwa.

Yatiqatasatha amuykipapxañäni

5. Yatiqiri masinakaruru ist'awsina ukhama warurt'awsina, warurt'awi tuqitha aruskipma.

- ¿Yatiqiri masinakaruru, wilamasinakaruru, qura qullanakaxa kunathsa pisiki yäqataxi, uka yatiyañaxa wakisisphati?

Jisa



Janiwa



- ¿Kunathsa?

Milliraya Aylluna qura qullanakampi qullasitapatha yatxatapxañäni

6 Laphi



Yatiqañataki wakichasipxañäni

1. Qillqatana p'iqinchiripa ullma ukatha jiskht'anakaru kutt'ayma.

- ¿Qillqataxa kuna tuqithsa yatiyaspachani? ¿Kawkiri qura qullanakathsa jispachistani?

Askipacha yatxatapxañäni

Utana qura qullanaka uywasiña

Milliraya Aylluna mä uruxa Juliku achachilajaxa thaypacha allphaqa chicharuna manq'antäsina kuliku usumpiwa t'aqisitayna, janiwa kawki tuqiru sarañsa yatkänti.

Jak'ana utjasirixa, khuyaña warariri ist'äsina jupa thiya mantatayna: "jani sinti t'aqisimpi, nayawa qullamama, mansanilla, rura, ukhamarusa inuju, utana uywasipunthwa, ukanaka wakichata junt'u umaru umantäta", sasa.

Achachilaxa uka qura qullanaka wallaqita umantäsina walipxatayna. Jupaxa, uka uruthpachawa qura qullanaka utapana uywasxatayna, "qullirinaka" sasa sutiyasa.



2. Ullawsina, yatiqiri masinakamampi aruskipma, ukatha jiskht'anakaru jaysma:

- ¿Qillqataxa kawkiri aylluthsa arxaychistu? ¿Ayllumana uka qura qullanakaxa utjpachati?

3. Ayllumana kawkiri qura qullanakasa wali uñt'ataxa, uka sixsma, ukatha kuna usunaka qullañatakisa uka yatiyarakma.

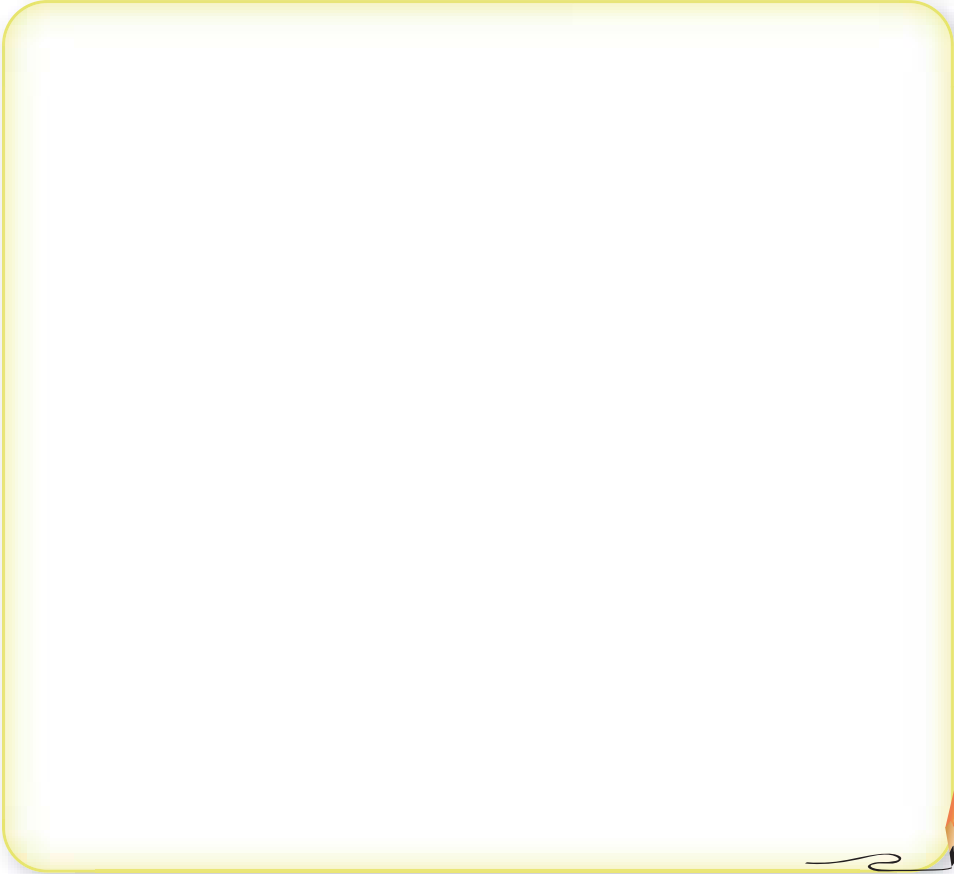

Yatiqatanakasatha amuykipapxañäni

4. ¿Achachilana sarnaqawipaxa askipachänti? ¿Kunathsa?

5. ¿Utana qura qullanaka uywataxa kunsä yatiychistu?

Qura qullanakampi qullasiñxata yatxatapxañäni



Aski wakisiri utjirinaka:

Jichha pachanakaxa jaqinakaxa usunakatha qullasiñatakixa jilapacha yaqha jani uñt'ata qullanakakwa apnaqxapxi.

Yaqhipa achachila awichasa arsuskarakiwa: "Qura qullanakaxa kunaymana usunaka qullañataki utjaskiwa", sasa.



Ch'amt'añasa.

¿Kunsa kamachapsnaxa qura qullanakampi aski qullasiña yatipxañasatakixa?

Lursuña: Qura qullanakana wakisitapatha yatxatäsina qillqatanakampi, sixsutanakampisa ukhama, mayninakaru yatiyapxañäni.



1 Laphi

Qura qullanakatha yatxatapxañäni

Yatiqañataki wakichasipxañäni

1. Yatiqiri masinakamampi aruskipma.



Qura qullanakasaru yäqañasawa. Walja qura qullanakasawa utjchistu, jichhürunakanxa uka yatiwinakasa chhaqtaña munxaraki.

Askipacha yatxatapxañäni

2. Akiri qillqata ullapxañäni.

¡Ist'apxañäni!



Inti wawaxa mä yatiya ist'äna: **“Mä wilamasiwa ayllusana sinti usuta, jani uñt'ata ñanqha usumpi katutjamakiwa”**, sasa. Jaqinakasa aski llakitäpxiwa.

Jayp'u chiqaruwa mä yatirixa aski maskarillasa uchkatasita, khaya: iwkalitu, salwiya, sipirisa, matiku, ajusa, limuna apt'atawa utaparü saräsina mä chikatampixa jiwq'impü jiwq'suyäna, mä chikatampirakiwa junt'u uma wakichäsina umantayarakina.

Ukhamathxa wali jump'süna, junt'u umampi warantatjama.





Jichhaxa waliptirjamaxänawa, sapxiwa.

3. Arsuwimpi jiskht'awinakaru kutt'ayma.

- ¿Kunathsa qillqatana, p'iqinchapaxa jlst'apxañäni! sixa?
- ¿Khitisa qulliri saratayna?
- ¿Kamsañsa muni “**Mä wilamasiwa ayllusana sinti usuta, jani uñt'ata ñanqha usumpi katutjamakiwa**”, ukaxa?
- ¿Yatiri jani sarkasphana ukjaxa kamachasphansa?

4. Chiqapa kutt'ayawi mä (X) chimpuntma.

- ¿Kuna lurawinakasa k'umarañasataki yanapchitasphaxa?

Yuqalla wawanaka	Yanapiwa	Janiwa yanapkiti	Imilla wawanaka	Yanapiwa	Janiwa yanapkiti
					
					



Wilamasimampi kuna jani walt'awinakasa utjaspha qura qullanaka pisi yäqatatha, uka tuqitha aruskipma.

5. Jani jiwaspacha yäqasipksna ukjaxa kamachasphasa, uka tuqitha sixsma ukatha qillqama.

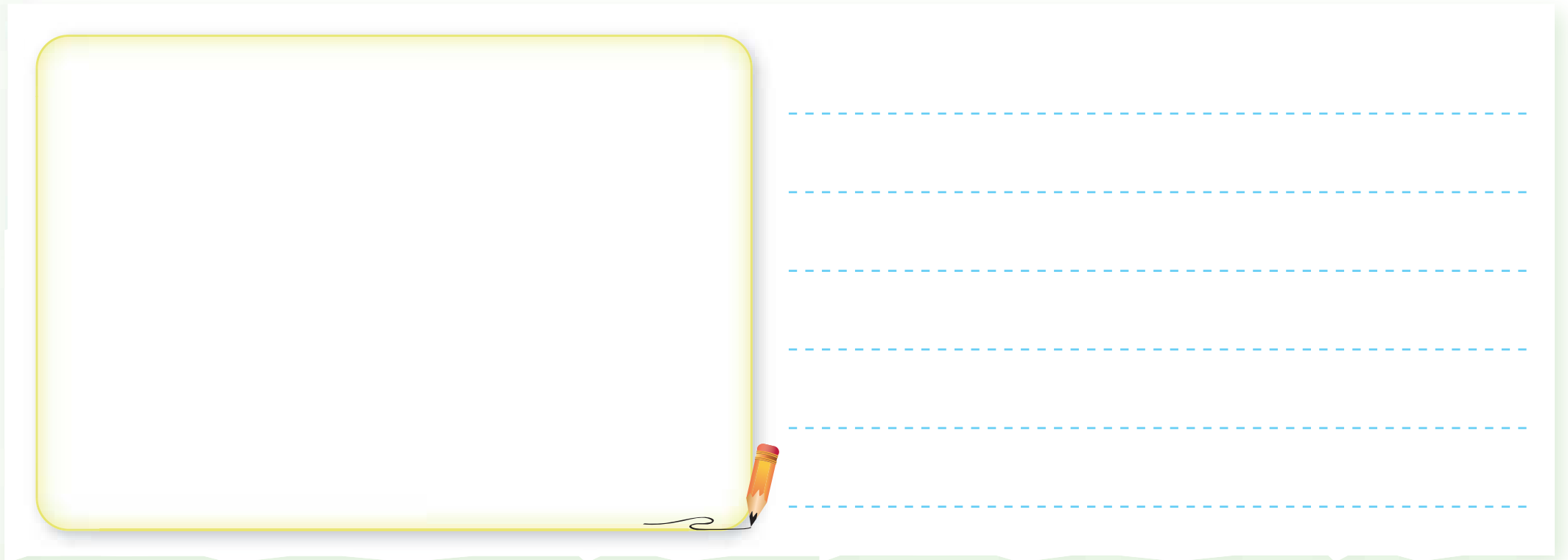

6. Yatiqaña utana qillqatamampi, sixsutamampi yatiyima.

Yatiqatasatha amuykipapxañäni

7. Jiskht'awinaka ullma ukatha chiqapa kutt'ayawima samichma.

- ¿K'umarañasataki qura qullanaka jani yäqhapsna ukjaxa kunasa kamachaspha uka tuqitha yatiñasaxa wakispachati?

Jisa



Janiwa



- ¿Kunathsa?

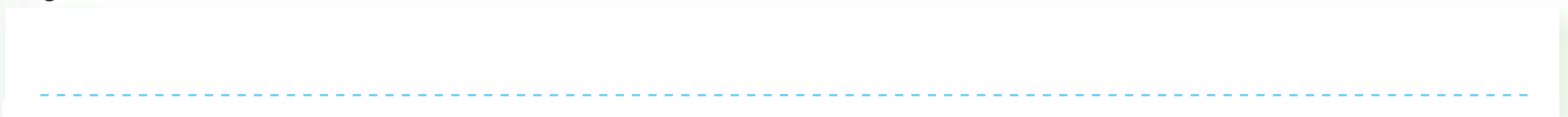

Qura qullanakana wakisitapatha ullapxañäni



Yatiqañataki wakichasipxañäni

Janira ullkäsina yatiqiri masinakamampi aruskipma:

¿Kunathsa qura qulla umañaxa aski wakisiri?



Qura qullanaka jani umiphanxa kuna ususa katusikiwa.

Askipacha yatxatapxañäni

Jichhaxa ullapxañäni, ukatha lurañanaka lurapxarakiñäni.

- 1. Tarjitankiri jamuqanakana, kikipa sallaniru tukuyiri sutinakani yaqha yaqha samimpi muyuntayma.



Yatiqiri masinakamampi kikipa sallaniru tukuyiri arunaka saña anatapxañäni.



2. Akiri jamuqana qura qullanaka uñxatma, ukatha k'ataki jakitama jamuqanaka sutinchma.



Yatiqiri
masinakasampi
anatapxañäni.
¿Khitisa k'ataki
jambuqanaka
sutiñchixa?



3. Yatiqiri masinakamampi mä muyunkasa, kikipa kasta sutinaka sañaru anatapxañäni.

Qura
qullanaka

muña

matiku

chhijchhipa

...

Panqaranaka

kantuta

sank'ayu

panti panti

...

Achunaka

jiwra

siwara

jawasa

...

4. Qura qullanaka q'ipina, jani uka kasta arunaka utjiri samichma.

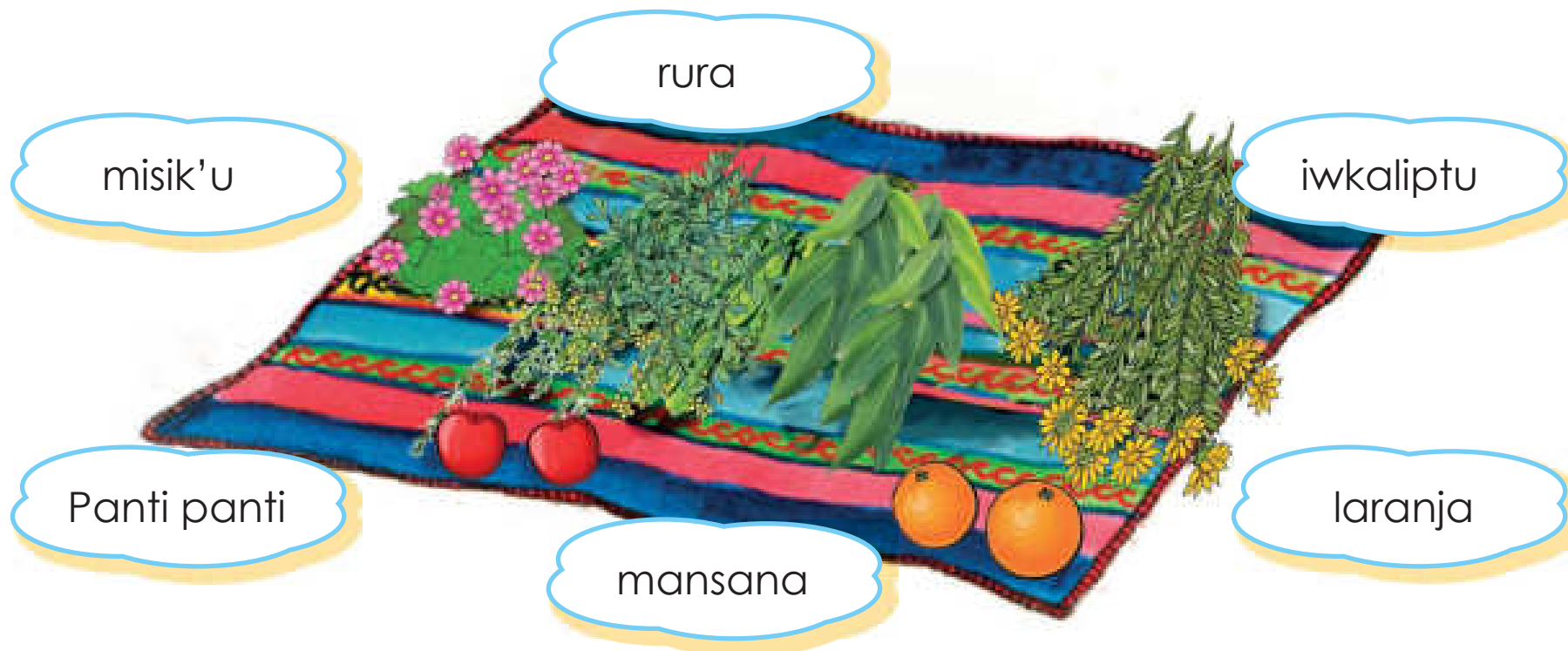

5. Jamp'atuxa jisk'a amuyunaka apanchistu, chiqapa aski amuyuninaka samichma.

Jamp'atuxa qura
qullanakwa uñjixa.

Jamp'atuxa
chhichhirankanaka manq'i.

Jupaxa junt'u
qullanaka umi.



Jupaxa qulla
umaña muni.

6. Arunakampi anatapxañani, ukanxa yatiqiri masimana arsutaparuru tukuyiri sallapampi qalltasa yaqha arunaka arsuñawa.

atapallu – lluku - kuka - kayu - yuru - rura...



Yatiqiri masinakamampi khuskata arunaka sañaru anatapxañani.

7. Jamuqa uñxatäsina sutipa arsama, ukana tukuyiri sallampi qalltki uka aru samichma.



kuka

kayu

kisu



llachu

lluch'u

llika



ñiq'i

ñik'uta

ñaxtu

Yatiqatasatha amuykipapaxañani

8. Jiskht'anakaru jaysma.

- ¿Akiri laphillata kuna arunaksa yatiqawtasti? ¿Kuna sallampisa arunakaxa tukuyi? ¿Kunjamsa yatiqawtasti?

Qura qullanaka tuqitha maya jawari ulläsina qillqapxañäni

3 Laphi



Yatiqañataki wakichasipxañäni



Inti wawana sarnaqawipatha ist'apxañäni.

Askipacha yatxatapxañäni

1. Janira qillqata ullkäsina, jaysma:

¿Kuna kasta qillqatäpachasa?

¿Kuna tuqitha qillqatäpachasa?

2. Qillqata ch'ujuki ullma, ukxaru uñ'atama arunaka muyuntayma.

Inti wawana qulla umapa

Inti yuqallaxa suxta marani wawänawa, utapana akiri qura qullanaka uywapxäna: mansanilla, inuju, rura, llantina.

Yatiqaña utaruxa kunaymana suma qulla uma apasirina, jupaxa umatha wañjataxa uka qullwa umt'asirina.

Mayni wawanakaxa taykanakaparu akhama sapxirina: "Inti wawjama qulla uma apasiña munarakikthwa", sasa.

Ukhampuniwa, qhipa urunakaxa taqi wawanakawa kunaymana akiri qulla umanaka apasinipxirina: salwiya, rura, mansanilla, muña, matiku, panti panti, yaqhanakampi.



3. Akiri qillqata ullawsina, arsuwimpi kutt'ayma:

- ¿Inti wawasti kuna qura qullanakaninasa? ¿Inti wawaxa utapana kunatakisa qura qullanaka uywatayna?

4. ¿Mayniri wawanakaxa kunathsa uka qulla uma munapxpachäna?

Utana qura qullanaka uywatana sutinakapa amtma. Sapa aru qhawqha sallaru jaljatasa jukha kuti samichma.



--	--	--	--	--



--	--	--	--	--

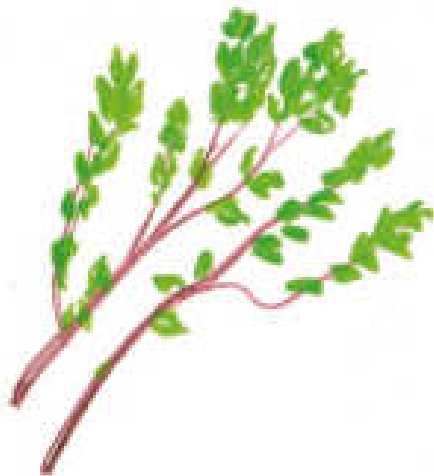

--	--	--	--	--



--	--	--	--	--

Yatiqiri masimampi
luratanakama
uñxatapxma
ukatha kunjamsa
lurapxtaxa
uka tuqitha
aruskipapxma.



5. Matikuna jawart'apa aski ist'ma.

Matiku

Matikuxa taqinitakisa jani uñt'atänawa, utjawipanxa wali yäqata munañani ukhamänawa; kunaymana usunaka qullarakirina, usuchjatanaksa k'atakiwa waljtayäna. Markaru sarxäna ukjaxa janiwa khitisa yäqخانati. Matikuxa uyusa uruwa umatha pharjata, thayjata, ukhamawa jaya chiqaru utjiri saräsina uñjasina.

Maya uruxa, jaya yaqha tuqitha mä ñanqha usuwa puriniina walja jaqinakaruwa jiwarayäna. Ukana qullirinakaxa matiku umañawa sasawa iwaxapxäna. Markankiri jaqinakaxa jawsapxänawa, matiku kawkinktasa, matiku jutma, masinakajasma ukwa munapxtha, sasa.

Ukhamawa Matikuxa wali amtata wasitatha uñjasina, jaqinakaxa juparuwa munapxäna, laphinakapasa wali jilaräna, panqart'xäna ukhamawa, jaqimpi utjasiñataki.



6. Ullawi ist'awsinxä, jiskht'anakaru arumpi jaysma:

- ¿Matikuxa kunjamänasa utjawipanxa?, ¿kunathsa Matikuxa jaya chiqa jark'ata uraqiru utjiri sarpachansti? ¿Qullirinakaxa kamsasa iwaxapxäna? ¿Matikuxa khitipachanasa? ¿Matikuxa khusäpachati?

Jisa



Janiwa



- ¿Kunathsa?



Jawart'a
ist'awasinxä, mä
jawari qillqma.

7. Janira qillqäsinxa, arsuwimpi jaysma.

¿Kunsa qillqajasti?

¿Kunatakisa qillqajasti?

¿Khititakisa qillqajasti?

8. Jawart'ama qillqma, ukatha sixsma.

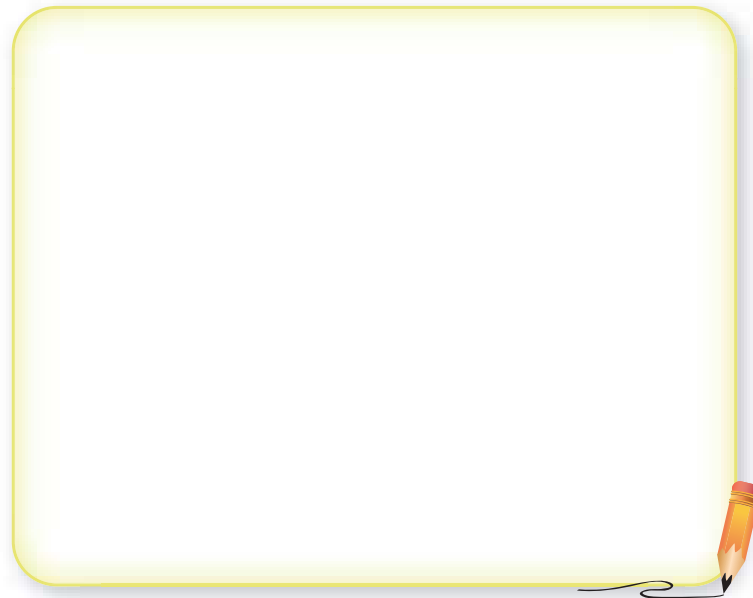

Yatiqiri
masinakamataki
jawart'a
qillqatama
ullt'ma.



Yatiqatasatha amuykipapxañäni

9. Jaysma.

- ¿Kunsa qura qullanaka tuqitha yatiqthanxa? ¿Kunjamsa yatiqthansti?
- Wilamasimampi k'umara uñjasiñama tuqi ukhamasa qura qullanakampi qullasiña tuqitha aruskipma.

Yatikipayasipxañäni

4 Laphi



Yatiquañataki wakichasipxañäni

1. Yatiqiri masimaru sixsutama uñxatayma, ukatha aruskipma.

- ¿Kunathsa janira inti jalskiphana qura qullanakaxa apthapiñäpacha?
- ¿Kuna yatiwinakasa yatiña qura qullanaka apthapiñatakixa?



Askipacha yatxatapxañäni

2. Yatichirimampi simana santana qura qullanaka apthapiña yäqawitha aruskipma, ukatha yatiqatama sixsma.

Qura qullaxa
janira lupi jalsunki
ukjapuniwa
apthapiñaxa aski
walichiriñapataki.





Yatiqaskakiñäni,
jichhaxa rima ukampi
lurapxañäni.



3. Janira qillqäsina, yatichirimaxa kunjamsa akiri rima ull'ixa uka ist'ma.

Qullu patana,
qura qurana.

Qura quririxa,
quriki apthapixa.

Utana umasiñataki
K'umaräñataki.



Uka rimxa
wasitatha jisma.

4. Yatiqiri masinakamampi aruskipma: ¿Nayriri qillqatana kawkiri arunakasa rima ukanixa? Jakisina chimpuntma.

5. Rima ukani arunaka jakma.

Jisnawa:

mansani**lla** - kan**lla**

iwkalip**tu** - amaysap**tu**

6. Akiri

a p n a q a ñ a

q i l l q a n a k a

uka

qillqanakampi yatiqiri masinakamana sutinakapampi ukhamaraki yänakana
sutinakapa kikipa sallaru tukuyirini arunaka wakiyma. Ukhamarusa kunaymana sutinaka
wakiyasmawa. Wakichatanakaru qillqantma.

Yatiqatasatha amuykipapxañäni

7. Lurañanaka lurawsina, jaysma:

- ¿Kunathsa qura qullanaka apthapiñtaki yatiñasti wakisiriispha?
- ¿Kunatakisa rima jarawt'añanaka yatiqawthanxa?



5 Laphi

Lurataja uñt'ayaja

Yatiqañataki wakichasipxañäni

¿Qura qullanaka
k'umaräñataki jani umapksna
ukjaxa kamachasphasa, uka
qhanañchasmati?

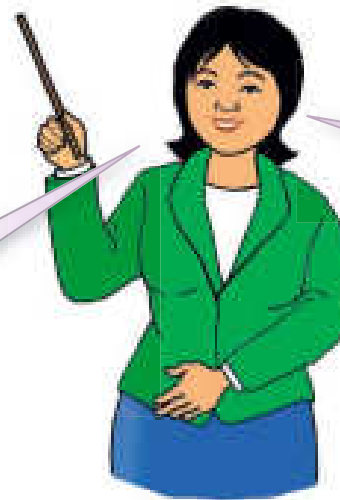

¡Lurapxañäni!

Askipacha yatxatapxañäni

1. Qura qullanaka pisiki apnaqataxa kamachasphasa, uka tuqitha janira yatiykäsina amuyunakama qillqma.

Handwriting practice area with ten horizontal dashed lines.

2. Jichhaxa, qillqatamatha sixsma.



3. Qillqatamampi sixsutamampitha, yatiqiri masinakamaru wilamasimampiru, jani qura qullanakampi yäqasipxsna ukjaxa kamachasphasa, uka tuqitha qhanañchma.

Jani qura qulla umiriksna ukjaxa kamachasphasa, uka tuqitha qhanañchapxañäni.



Yatiqatasatha amuykipapxañäni

4. Arsuwimpiki kutt'ayma:

- ¿Qura qullanaka jani umiriksna ukjaxa kamachapsnasa, uka tuqitha qhanati qhanañchawimaxa?

5. Wilamasimaru yatiyma, ukhama amuyunakama qhanañchma.



1. P'iqincha ullt'ma ukatha jiskht'anakaru kutt'ayma:

- ¿Qillqataxa kuna tuqithsa yatiyaspacha? ¿Kawki aylluthsa jischitu?

Ñukch'u apthapiña.

Sapa Juywisa santu arumaxa, waynanakaxa khuyapt'ayasiñtakixa ñukch'u panqararu yupaychiri Apu achachila patxanakaruwa mistsupxi, ukathxa wirnisa simana santa qhantatiwa apthapipxarakini.

Qhantatanxiphaxa, waynanakaxa ñukch'u apthapiri Apu patxa atipa atipawa mistsupxaraki. Ñukch'u qura qullaxa tatituna khuyapayatawa sapxiwa.

Ukhamawa wali munasiñampi, aski yäqasiñampi junt'u umaru ñukch'u umapxani; ukaxa kuna jani walt'awinaksa qullapuniwa sapxarakiwa.

Wirnisa santu uruxa chachanakasa, warminakasa, wawanakasa taqiniwa, qura qullanaka apthapipxixa.



2. Ullawsinxá, yatiqiri masinakamampi aruskipma ukhama jiskht'anakaru jaysma:

- ¿Qillqataxa kawki chiqa aylluthsa yatiyistuxa? ¿Waynanakaxa juywisa santu arumaxa kamachapxisa? ¿Kunathsa Ñuñuwa ayllunakana wirnisa santu uruxa qura qullanaka apthapipxi? ¿Kamsañsa muni "yupaychañataki" ukasti?

3. Ñuñuwa ayllunakana ukhamaraki ayllumana kunjamsa qura qullanakxa apthapipxi, uka tuqitha sixsma, ukathxa kunanakasa kikipa ukhamarusa mayja ukanaksa qhanancharakma.

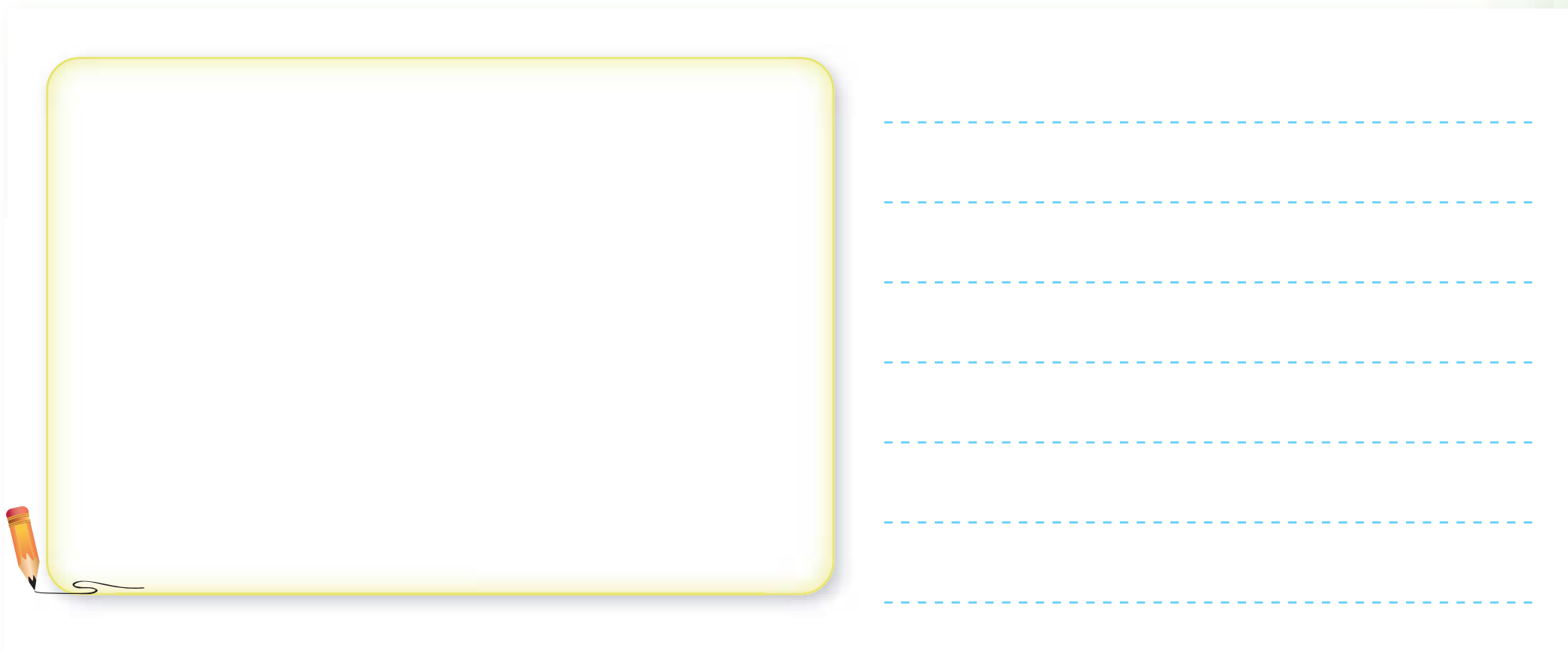

Yatiqatasatha amuykipapxañäni

- 4. ¿K'umaräñataki qura qullanaka apthapiñatha yatiqatamaxa askiti? ¿Kunathsa?**
- 5. ¿Ñuñuwa ayllunakana ukhamarusa ayllumana yatiwinakapaxa kikipati? ¿Kunathsa?**



¡Anatapxañäni!

Qura qullanaka apthapkirixsixsusma ukhamaraki sutima qillqisma.



Sixsutama akiri
361 laphinkiri
lip'katayañanakampi
suma
k'anchachayma.



Sutija:

2ri
T'aqa

Yapunaka apthapipxañäni



¿Kunathsa yapunakaxa pisiki achuqawxi?



Aski wakisiri utjirinaka:

Jichha pachanxa yapunakana achunakapa apthapitaxa juk'akixiwa, ukaxa, luririnakaxa janiwa pachaparu yapuchxapxiti, Ukhamarusa yapuchaña lumasanaksa janiwa yäqxapxiti.

Ukhamathwa yapunakaxa pisiki achuqawxixa, janiwa nayra pachjamxa achuqxiti.

Uñxatma ukatha Kutt'ayma:

1. ¿Kunsa jamuqanxa Jaqinakaxa lurasipki?
2. ¿Ukhama lurawinxaxa yanapiritati? Aruskipma.



Ch'amt'añasa:

¿Kunsa lurapsnaxa yapunaka pisiki achuqipanxa?

Lursuña: Yapunakana achuqatapa sixsma ukhama mayninakaru yatiyima.

Yapuna achuqanakapa achuqatapatha yatxatapxañäni

1 Laphi



Yatiqañataki wakichasipxañäni

1. Yatiqiri masinakamampi aruskipma.

Amaru jilajaxa ch'uqi llamayuriwa sarixa.



Manq'asiñataki walja achuqanaka utjaspha ukawa munasixa.

Askipacha yatxatapxañäni

2. Akiri qillata ullapxañäni.

Ch'uqi llamayuña

Philipi tataxa, Luwisa warmipampi wawanakampampi wali alwatha yapuru sarapxäna, musq'a ch'uqinaka llamayuñataki, lijwanasa apt'asita, ukhamarusa manq'añataki waja lurañwa amuyasipkäna.

Purisinxa, p'isaaqampi jat'januqatwa jakipxäna mä tuqithxa laq'untataraki. Ukhama uñjasinxä wali llakitawa jikxatasipxäna.

Ukhamayphana, tataxa akhama sänawa: "Jicha pachanakanxa janikiwa yapu aski yapuchapxthanti ukatha akhama laq'usa laq'untawxi, yaqha uywanakasa pisipayxi", sasa.



3. Qillqata ullawsinxä, arst'asa jaysma.

¿Philipi Tataxa
wilamasinakapampi
yapuruxa kunsä
apapxäna?
¿Kunatakänsä?

¿Kunathsa
achuqaxa
pispachakixi?

¿Qillqatanxa
kunanakasa
pispachakiniwa
achuqaxa sasa
yatiyistu?



4. Jiskht'anaka ist'ma ukathxa kutt'ayawimaru phuchasa ukatha (X) chimpuntma.

- ¿Kunathsa Philipi tataxa wilamasipampi llakita uñjasipxäna?

- ¿P'isäqasa kikiparaki laq'usa ch'uqi yapu ñanqhachpachati?

Jisa



Janiwa



- ¿Kunathsa?

5. Kunathsa achuqaxa pisikixi uka tuqitha wilamasimampi aruskipt'ma. Ukathxa sixst'ma ukhamaraki qillqt'arakma.

Handwriting practice area with a large yellow box for drawing and a set of blue dashed lines for writing.

Qillqt'atama
sixst'atamsa
masinakamaru
yatiyma.



6. Yatiqiri masinakamampi kunathsa ch'uqi achuqaxa juk'akixi uka yatxatawimatha aruskipt'ma.

Yatiqatasatha amuykipapxañäni

7. Jiskht'awi ullt'awsina chimpuntma.

- ¿Yapu wali achuqañapatakixa aski uywañaxa wakisiriti?

Jisa

Janiwa

• ¿Kunathsa?

Handwriting practice area with a blue dashed line.



2 Laphi

Achuqanaka apthapiña tuqitha ullapxañäni ukhamaraki qillqapxañäni

Yatiqañataki wakichasipxañäni

1. Yatiqiri masinakamampi aruskipt'ma.

P'isaqanaka kikiparaki
laq'unakasa
yaqhanakampisa
yapunaka
ñanqhachaspawa.



¡Yapunakasxa aski
uñjapxañasawa!

Askipacha yatxatapxañäni

2. Akiri qillqatana achuqa sutinaka samichma.

ch'uqi	C12s#	p'isaqa	kustala
a4568	jiwra	Ti#)=)ra	a&&ato
lijwana	¿¿plá o	apilla	ŵюΘ∞

3. Isaku wawaxa ch'uqi imañataki phina lursüna, ukathxa taypi k'achacht'äna. Jichhaxa qawayanakapana kikipa k'achachatanaka jikisina muyuntayma.

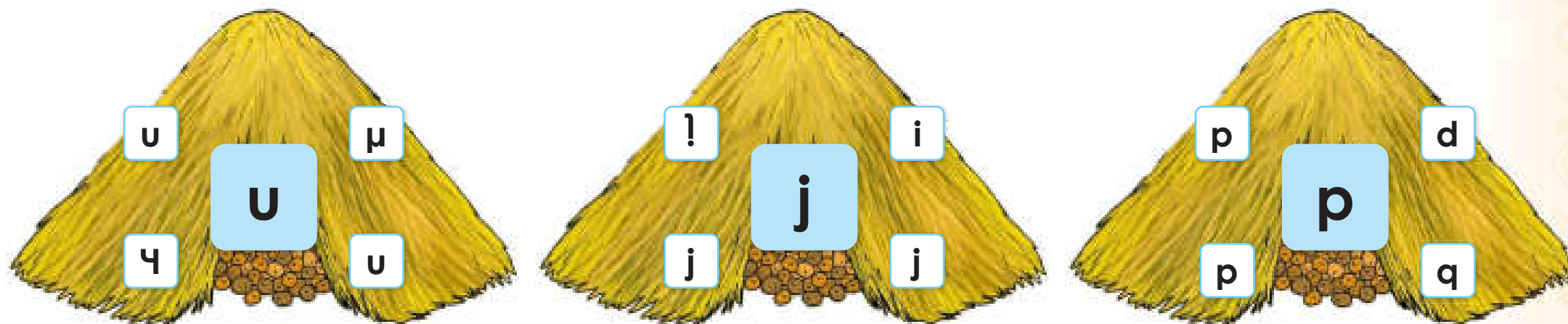

4. Phinanakapa k'achachañatakixa, Isaku wawaxa mayjanaka sixsutayna. Isaku wawana sixsutaparjama, nayraqatankiri uñaqäsina, kikipa jamuqanakäkisa ukanaka muyuntayma.

a	a	b	a	b
u	u	u	u	u
m	m	m	m	m
s	s	s	s	s

¿Phina lursuñatakixa
kuna yänakasa
wakisirixa?







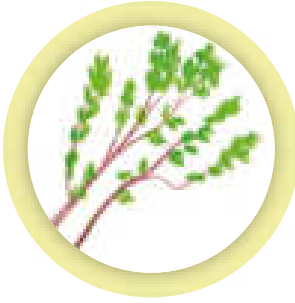

Wakisiri yänakana
sutipa qillksta.

5. Phina luraña yänaka ullt'ma ukatha sallanakaparjama tupayma.



6. Jamuqanakana sutinakapa uñaqma. Taypina kikipa sallanipki ukanaka (X) chimpuntma.

			
			X
			
			

Manq'aniñataki yapunakasa aski uywapxañäni.



7. Achuqa llamayuñataki wakisiri yänaka jamuqatanaka samicht'ma.

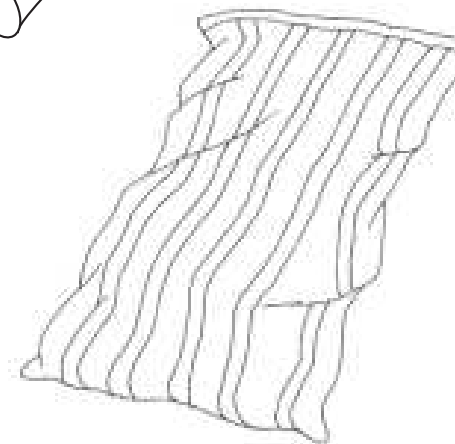
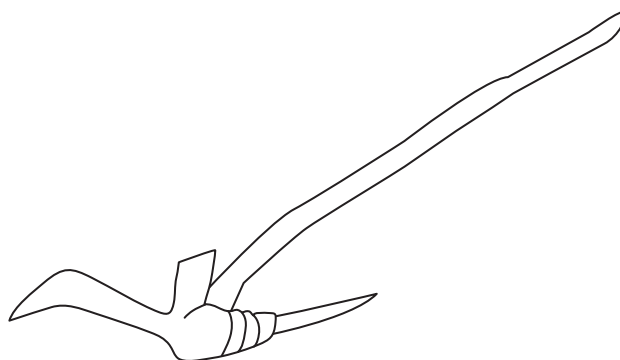
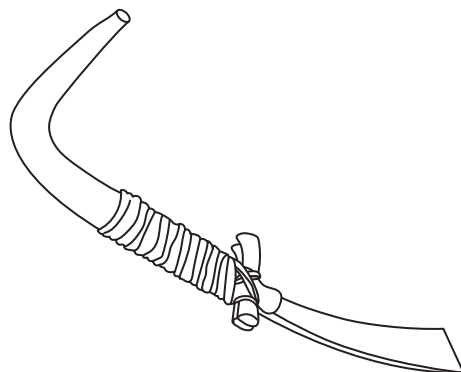
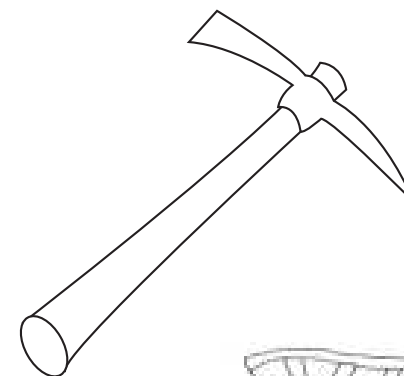
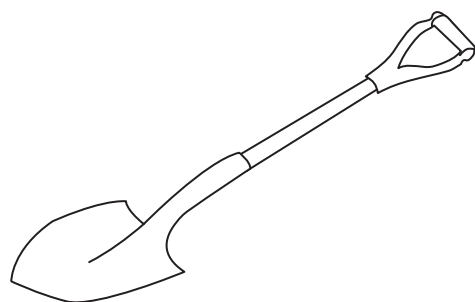
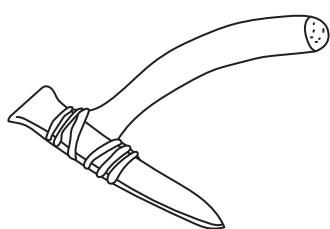



3 Laphi

Ch'uqi llamayuñataki yänaka tuqitha ull't'apxañäni ukhamasa qillqt'apxarakiñäni

Yatiqañataki wakichasipxañäni

¿Ch'uqi llamayuñataki kuna yänaksa apnaqthanxa?



¡Lijwana, pikulla, kustala,...!

Yatiqañanakasa juk'ampi yatxatapxañäni

1. Janira qillqata ullkasa, ¿kunsa katjawinakathxa yattaxa?
2. Qillqatxa ch'ujuki ull't'ma, ukathxa yatiqiri masimataki ullart'arakma, phuqacht'añatakixa sixst'arakma.

Ch'ullqhi k'umpacha,
thuru lawalläthwa,
chuntampi chikthapita,
ch'uqi apthapiñatakiwa
apnaqapxitu.

¿Khitipachäthsa?

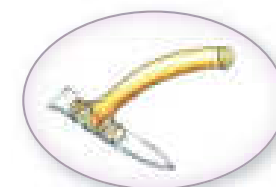
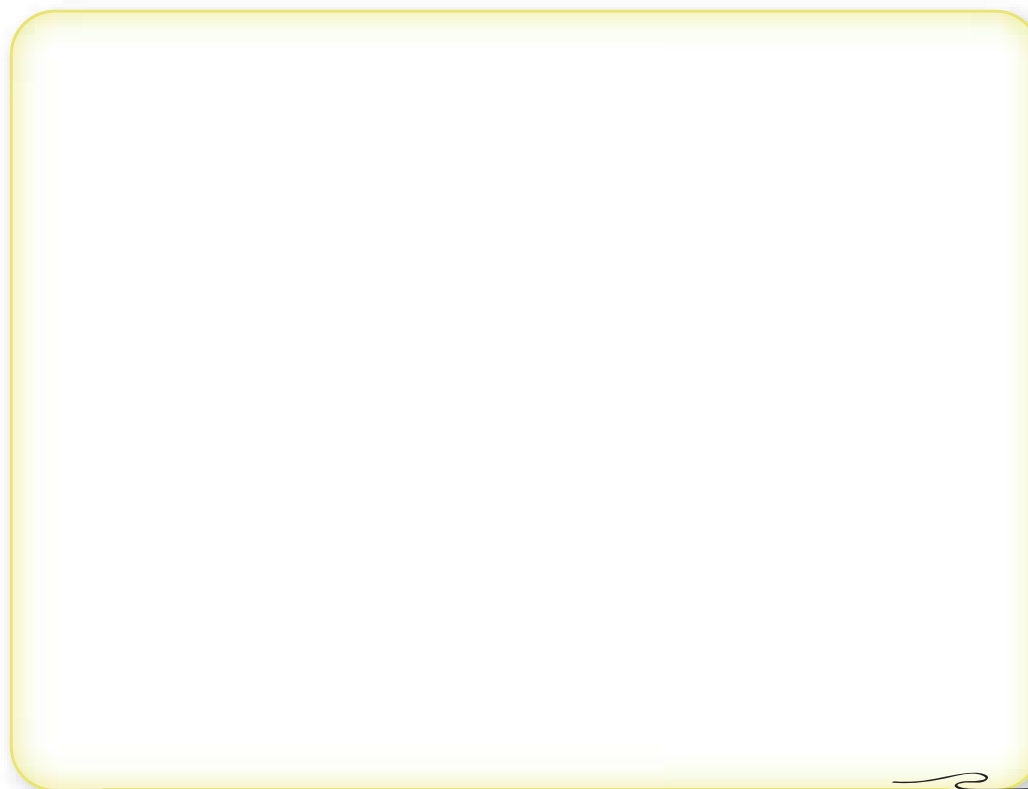

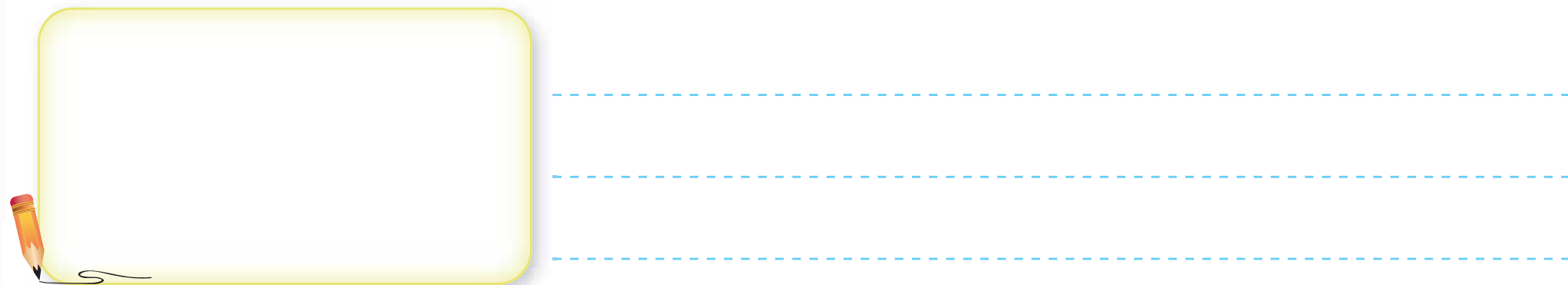

¡Nayaxa
kunasa ukxa
yatthwa!
¡Lijwanawa!

3. Jichhaxa mä katjawi qillqasma ukathxa sixst'arakma.



4. Arunaka arsutarjama, sapaqata wakisiriwjaru sixsma.

	ch'uqi	
	lijwana	
	llamayuri	

5. Nayrii siqi uñxatma ukatha awayu uka aruna qallta sallaparjama jamuqanaka muyuntayma.

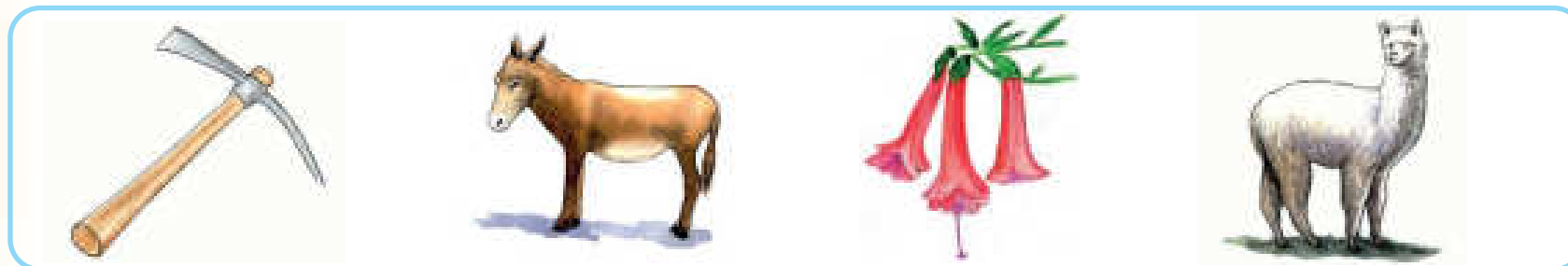
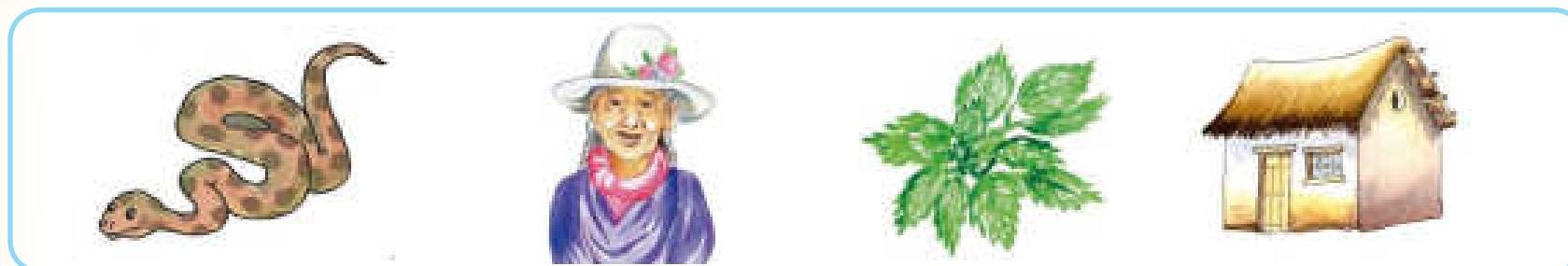
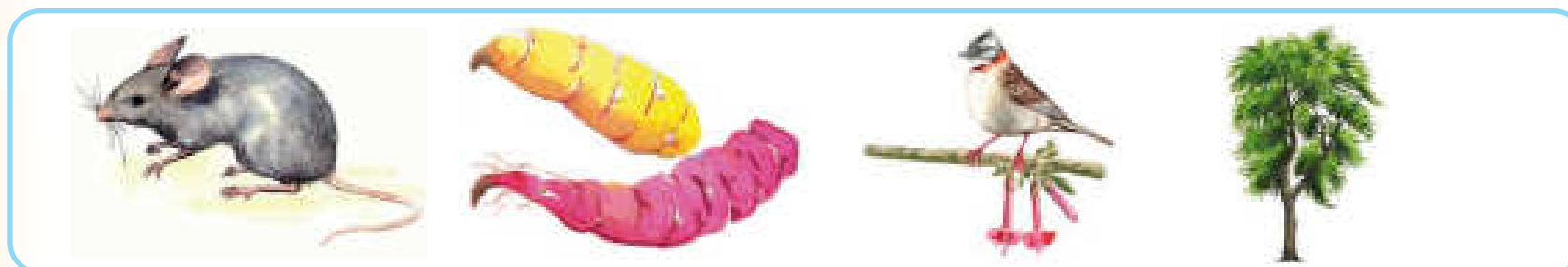

Ukathxa payiri
ukhamaraki
kimsiri siqinkiri
jambuqanaka
sutinchaskakma.



6. Jambuqanaka uñxatasina, sapa arutha jani nayiriri sallaniki arsuma.

Akhama: lijwana → wana



7. Ch'uqi llamayuña yänaka uñt'äsina, akiri jarawi ullt'ma.

Suma yapuja

(Jarawi)

¡Jisa! Akawa nayana



tatajawa k'uchi satawi

kunaymana kasta



jathampiwa,



jumawa imawtaxa.

Akawa nayana



ch'uqi llamaytha,

kikiparaki

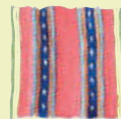

ukasa wakichatawa,

Wali k'uchisiñawa manq'axa utjawxiwa.

Yatiqiri
masinakamataki
wilamasinakamatakisa
jarawi yatiqatama
jarawt'ma.



Yatiqatasatha amuykipapxañäni

1. Jiskht'anakaru jaysma.

- ¿Kawkiri llamayuña yänaksa uñt'thana?
- ¿Kunatakisa jarawinakxa jarawt'thansti?
- Apthapita achuqa tuqitha mä jarawi, qillqma ukatha yatiqiri masinakamataki jarawt'ma.



4 Laphi

Yatikipasipxañäni

Yatiqañataki wakichasipxañäni

1. Jamuqa uñxatäsina yatiqiri masinakasampi aruskipt'añäni.

- ¿Kunsa p'isaqanakaxa yapuna lurasipki?
- ¿Kunsa yatiyistu p'isaqanakaxa yaputha ch'uqi waysxi ukha pachaxa?
- ¿Kuna yaqha lurasanakasa ch'uqi apthapiñatakixa utji?



Askipacha yatxatapxañäni

2. Yatichirimampi yatiqiri masinakamampi aruskipäsina, ch'uqi llamayuña lurasanakatha yatiqatama sixsma.

¡P'isaqawa yaputha ch'uqi waysxatayna, llamayuñäxiwa!





Jichhaxa jarawt'aña
yatiqañäni.



3. Janira jarawt'kasa, yatichirimana jarawi ullatapa ist'ma.

Lijwanaja

Ch'ullqi lawallata
aski luratawa,
chuntampi chikthapita,
nayaru aski yanapiriwa.

Ch'iki jani jayrasisa jasacht'iri,
muxsa ch'uqi llamayt'iri,
k'uchi manq'añajataki.

¡Jisa! K'umara, ch'ullqhi jaqiñajataki.

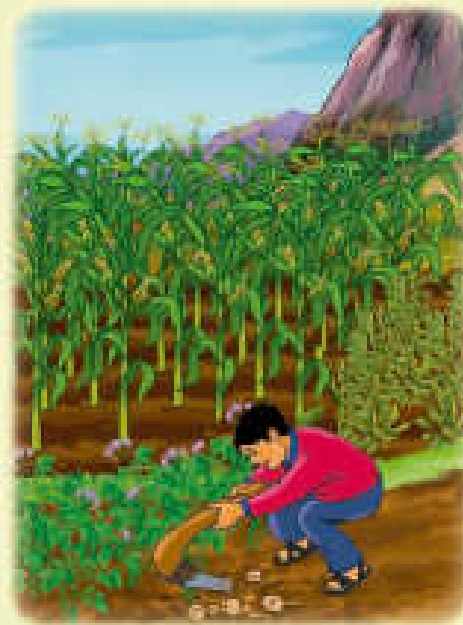

Yatiqiri
masinakamampi
chika jarawi
yatiqma.



4. Jarawi ist'awsina, yatiqiri masinakamampi aruskipt'ma.

- ¿Jarawixa khusänati?
- ¿Kawkiri jarawina qillqata t'aqasa khusänasti?
- ¿Kunathsa?
- ¿Yaqha jarawinakxa yatipxtati? ¿Kawkirinaksa?

5. Janira masinakamataki jarawt'kasaxa aka amtanaka phuqma.

Jarawi yatiqma.

Ch'amampi ukhamarusa qhana arumpi jarawt'ma.

Rima ukanaka katjma.

Rima ukanaka ch'amampachata arisma.



6. "Lijwanaja" jarawinxaxa kawkiri qillqata t'aqasa khusana uka sixsma.

Three horizontal dashed lines for writing.

7. Kutt'ayma. ¿Qillqirixaxa kamsañsa muni uka jisk'a amuyunxaxa: "¡Jisa!, k'umara, ch'ullqi jaqiñajataki", ukaxa?

- ¿Jarawi jarawt'tati, ch'amampi ukhamarusa qhana arumpiti?
- ¿Kunjamsa jarawt'atama k'atampi khust'ayasmasti?

Yatiqatasatha amuykipapxañäni

8. Kutt'ayma, ¿kunatakisa jarawi jarawt'aña yatiqtsti?



Yatiqañataki wakichasipxañäni

¿Sixst'aña munasmati ukhamasa kunanakathsa achuqanakaxa pisikxi uka tuqitha yatt'ayasmati?



¡Sixst'apxañäni ukathxa kunathsa achuqaxa juk'akixi uka tuqitha yatt'ayapxañäni!

Askipacha yatxatapxañäni

1. Janira yatiykasa, kunathsa achuqaxa juk'akixi uka tuqitha sixst'ma.

2. Jichhaxa, sixst'atamatha qillqma.

3. Qillqt'atamatha sixst'atamampitha, yatiqiri masinakamaru ukhamarusa wilamasinakamaru, kunathsa achuqaxa juk'akixi, uka tuqitha yatiyima.



Arst'äsina amuyunakama qhanañchma.

Yatiqatasatha amuykipapxañäni

4. Arst'asa jaysma.

- ¿Wakisiriti kunathsa achuqaxa juk'akixi uka tuqi yatiyañaxa?

Jisa

Janiwa

- ¿Kunathsa?

Ullaraya aylluna llamayuwipa unt'apxañäni

6 Laphi



1. P'iqinchapa ullt'ma, ukatha jiskht'anakaru jaysma.

- ¿Qillqatanxa kuna tuqithsa arspachaxa? ¿Kawki aylluthsa yatiyistani?

Ullaraya aylluna ch'uqi llamayuwipi

K'ank'a art'atathxa, Ullaraya aylluna utjasirinakaxa kustalanaka asnuru khumuñataki yänaka wakichapxi, kissa apapxarakiwa. Wali k'uchiwa ch'uqi llamayuri sarapxi.

Yapuchawinxä, taqi chuymampiwä Pachamamaru luqtapxi. Janira qalltkäsina kuka akullt'apxi ch'amanchasiñataki. Ukatha puruma uraqitha ch'uqi llamayuña qallantapxaraki, llamayurinakaxa mä chiqaruwa llamayjata qutuchapxi.

Chika urutakixa wajantapxiwa. Kisumpi ch'aqumpi wajampi chika taypiru uchäsina manq'añatakiwa samart'apxi.

Jayp'u chiqaruxa ch'uqi apt'atkamawa utanakaparuxa kutxapxaraki. Jilt'iri ch'uqxa pachparu jilt'ayawxapxi, suma alinakampisa imxat'awsina.

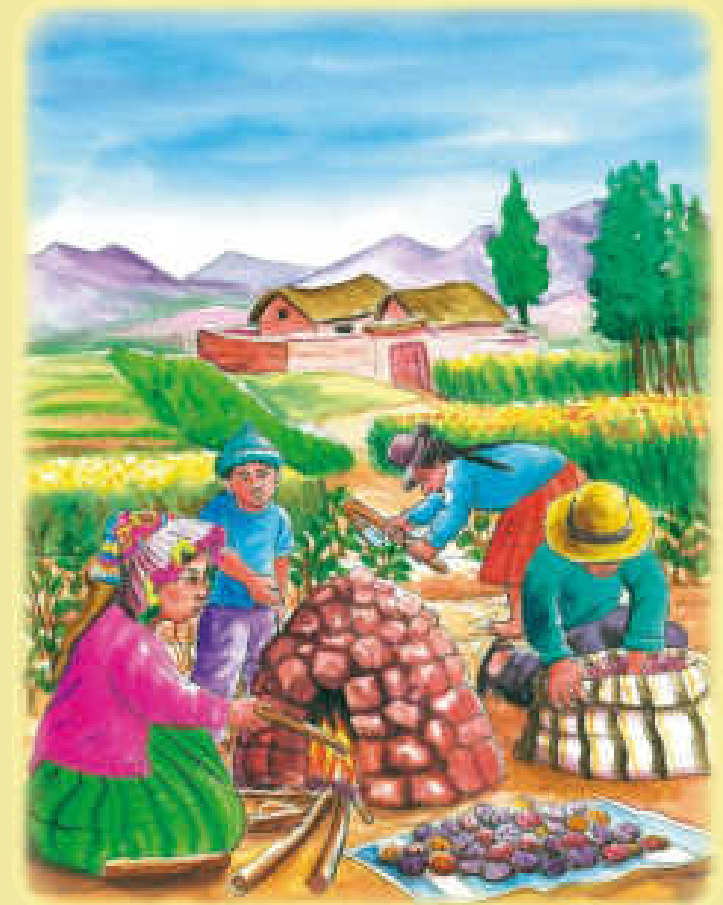

2. Ullt'awsinxaxa, yatiqiri masinakamampi aruskipt'ma ukatha jiskt'anakaru jaysma.

- ¿Kunampisa waja manqt'asipxi?
- ¿Ullaraya ayllu tuqina ayllusampina llamayuwinxaxa kunasa kikipaxaxa?

3. Ullaraya ayllunxaxa khitinakasa llamayusipki uka sixsma, ukatha utjawimanxaxa khitinakasa llamayupxi. Ukathaxa sixsutamatha yatiyma.

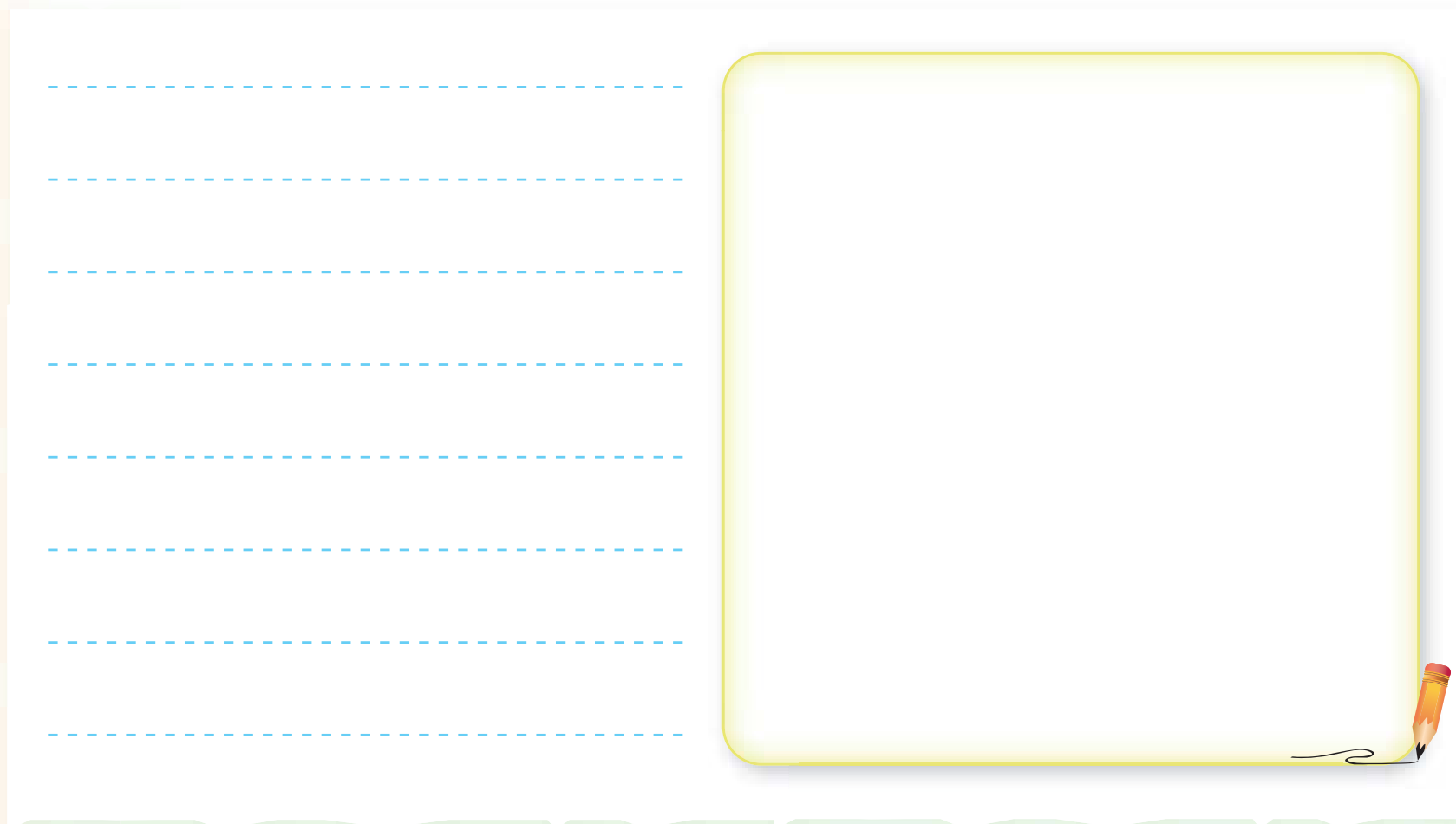

Jichhaxa yaqha
markawkana
llamuyuñxata
yatxatapxañäni.



Yatiqatasatha amuykipapxañäni

4. ¿Ullaraya ayllu tuqina llamayuwipa yatiqatamaxa khusänati? ¿Kunathsa?

5. ¿Ullaraya ayllu tuqina jiwasa ayllunakasampina llamayuwinxaxa kunanakasa kikipasti?

¿Kunathsa yapunakana achuqapaxa juk'akixa?



Askipacha wakisiri utjirinaka:

Jichha pachana jaqinakaxa yapu achunaka apthapiwina juk'aki achuqatapampikiwa jikxatasipxi, kunathtixa jupanakaxa janiwa amtxapxiti nayra yäqañanaka. Ukathkwa yapunakasa aski achuqañapataki lumasanakasa, ukhamaraki Pachamamarusa yäqañaxa wali wakisiriwa.

Uñxatäsina jiskht'awinakaruru jaysma:

Yapunakasana pisiki achuqatapa yatxatäsina jichhaxa ch'amt'añasa phuqapxañäni.

1. ¿Kunsa jaqinakaxa uka jamuqana lurasipki?
2. ¿Jumaxa uka lurawiru sarirítati? Arxayt'ma.

Ch'amt'añasa:

¿Kamachapxiriksnasa yapunakasana achuqatapa, jani achuqatapa, mayninakaruru yatiyañatakixa?



Lursuña: Yapunakana achuqatapa, jani achuqatapa, askipacha yatxatäsina maynikaruru yatiyañasawa.



1 Laphi

Yapunakana achuqatapa jani achuqatapa yatxatapxañäni

Yatiqañataki wakichasipxañäni

1. Wilamasinakamampi jani ukjaxa yatiqiri masinakamampisa aruskipt'ma.



Yapuxa suma jakañataki manq'añanaka churasi. Yapunakasafi jani achuqkaspha ukjaxa jani manq'anixsnawa ukhamathxa usuntaraksnawa.

Askipacha yatxatapxañäni

2. Akiri qillqata ullt'apxañäni.

Chhijchhina jawq'suta yapu

Juliku achachilana yapupa chhijchhiwa jawq'sutayna, jupaxa ukanamawa sarnaqäna. Yapupa k'utsufiphana llakitawa uñjatasina. Ali laphinakapasa taqi tuqiru ina laphjtatakina, janiwa mayasa askikataynati.

Achachilaxa akhama sänawa: "¡Yapujaxa q'ala chhijchhutawa! ¿Kunathsa juk'ampi nayra jani satpachayäthxa? Walpunwa amtasthxa. Jichhaxa kamacht'akija. Wawanakajataki achuqaxa janisa utjkchiniti ukhamjamawa", sasa.



3. Ullart'awsina, arsuwimpi jaysma.

- ¿Kunathsa qillqatana p'iqinchapaxa "Chhijchhina jawq'suta yapu" sispacha?
- ¿Kamsaña muni: "¡Yapujaxa q'ala chhijchhuta!", ukaxa?
- ¿Chhijchhixa yapuruxa kamachisa?
- ¿Yapu jani achuqxiqhana khitinakasa jani wali uñjasipxapacha? Qhananchma.

4. Yapuru ñanqhachirinakaxa kuna jani walt'awinaksa apanispha, uka sixst'ma.

Yapuru
ñanqhachirinaka

Kuna jani
walt'awinaksa apani



Wilamasisana yapupana
achuqanakapaxa pisipachakispha
ukjaxa kunarusa purt'asitäspha, ukathxa
kamachsnasa jani ukhamañapataki, uka
tuqitha aruskipt'ma.

5. Wilamasimaxa kunfi yatt'ayktama uka sixst'ma ukatha qillqt'arakma.

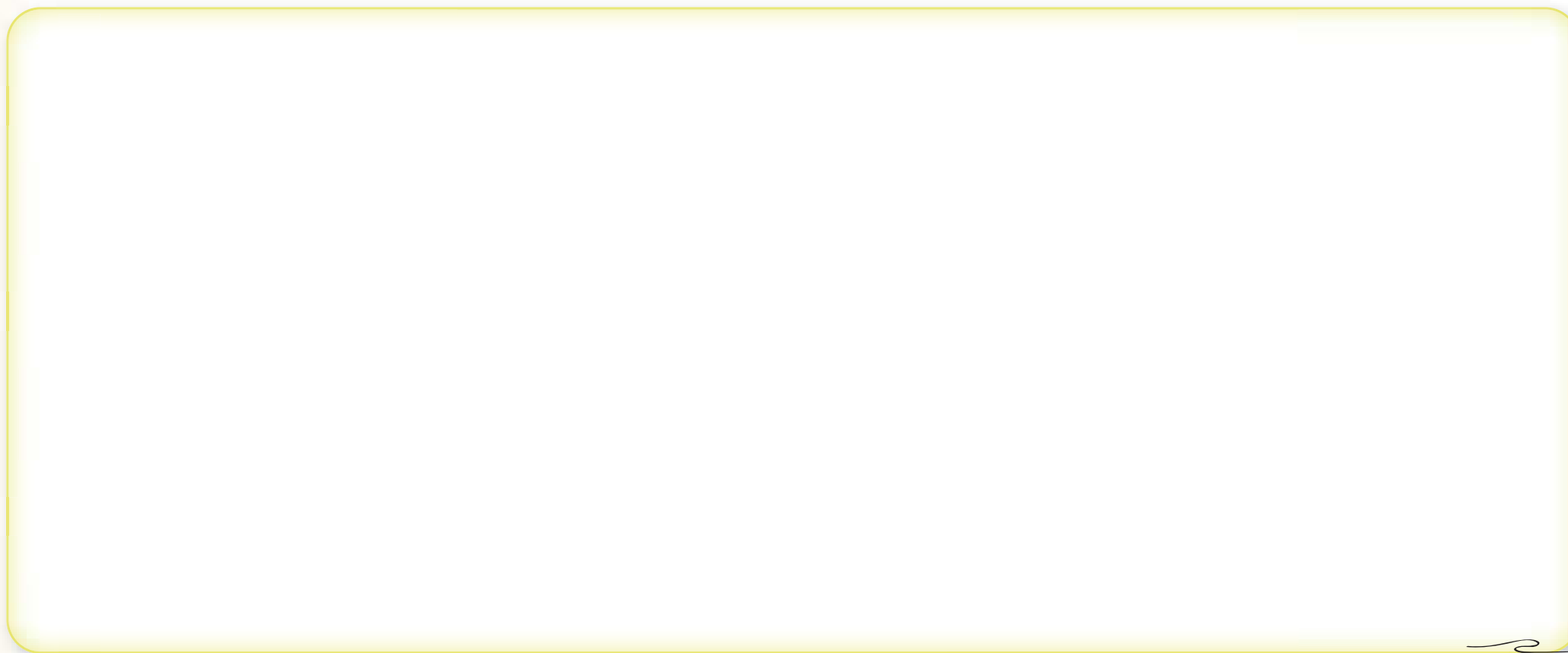

6. Yatiqawi utana qillqatama ukhamaraki sixsutama yatikipayma.

Yatiqatasatha amuykipapxañäni

7. Jiskht'awi ullt'awsina kutt'ayawima saminchma.

- ¿Yapuna aski achuqawipaxa wilamasinakasataki wakisiripachati?

Jisa



Janiwa



- ¿Kunathsa?

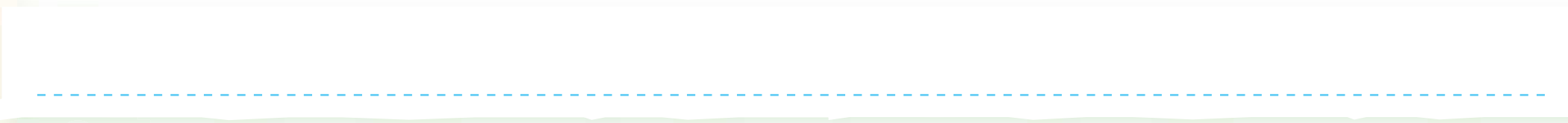

Yapu uywaña tuqitha ullt'apxañäni, qillqt'apxarakiñäni

2 Laphi



Yatiqañataki wakichasipxañäni

Janira ullkasa, qillqkasa yatiqiri masinakamampi aruskipt'ma.



Yapu utjiphanwa walja manq'asthana, ukhamaraki suma jakasthanxa.

Askipacha yatxatapxañäni

1. Wawanakaxa yatirimpi yapu luraña tuqitha aruskipapxi, jamuqanaka uñxatma.

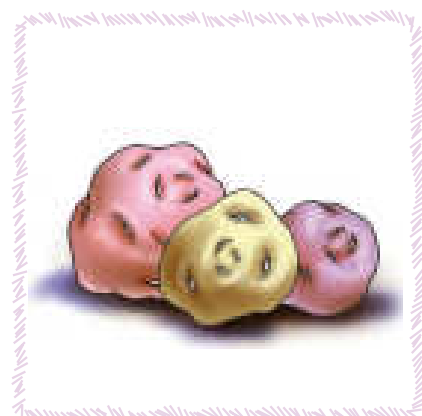

1

2

3



1

2

3



1

2

3



1

2

3

Sapa aruna aru jaljayata sallaparjama chimpma.



2. Akiri 361 laphinkiri llip'katayañanakampi wakisiriwjaru llip'katayma. Ukatha sutinakapa qillqasma sallanakaparjama.



● ●	● ● ●

3. Wilmasimampi jani ukjaxa yatiqiri masinakampisa jani jukha sallani arunakaru mä chimpumpi chimpuntañaru anatt'apxma.

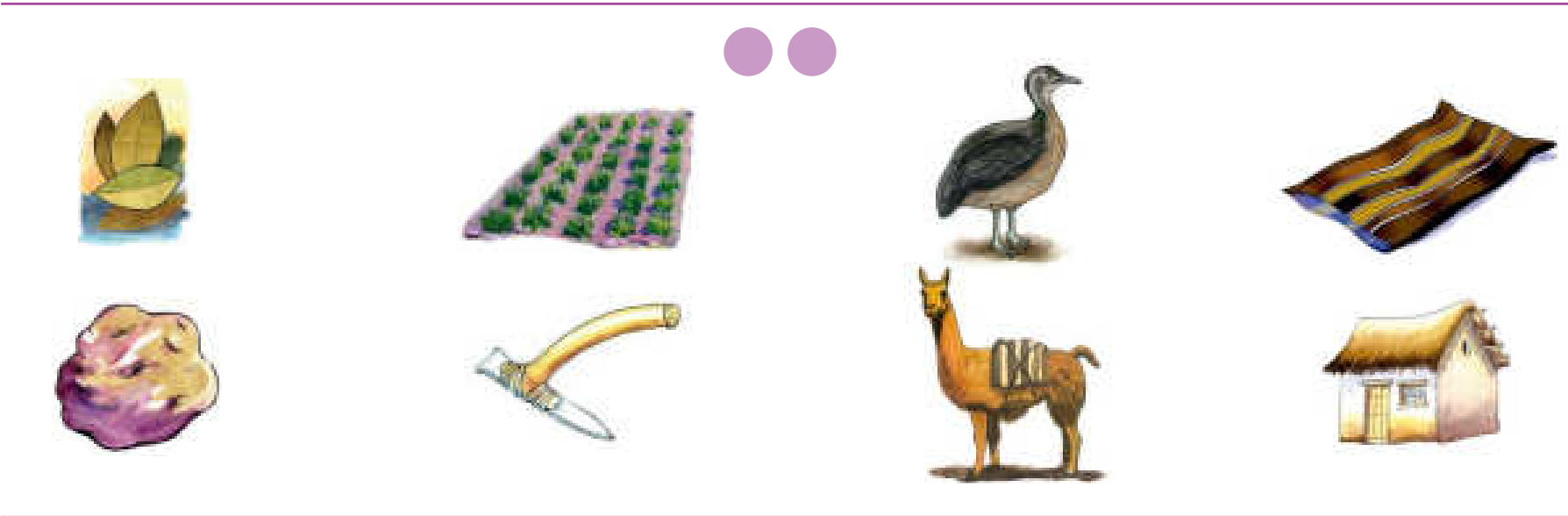

¡Sixsutanaka samichapxañäni!

4. Nayraqata pusik'uchunkiri sapaqata jamuqa ullma ukatha kikipa aru jaljayata sallampi qalltiri sixsutanaka samichma.

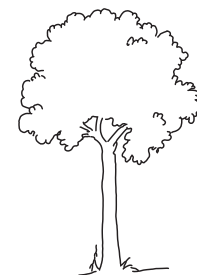
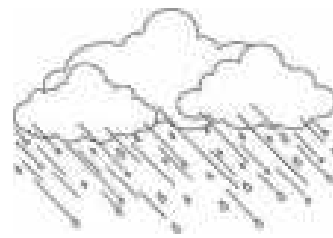
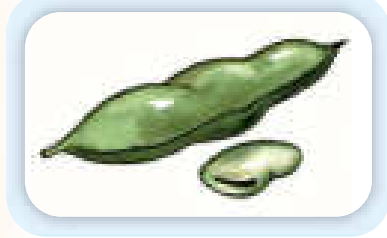
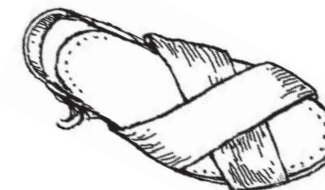
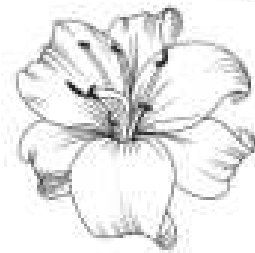
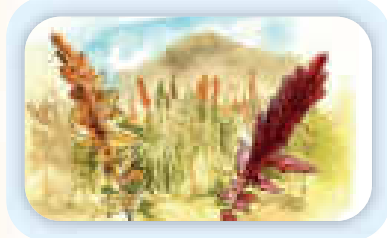
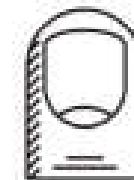
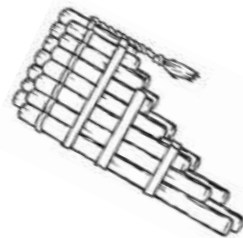
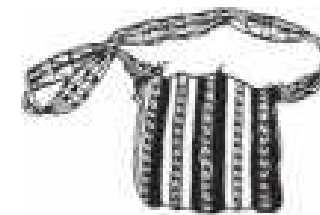
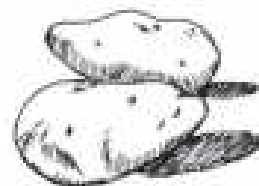
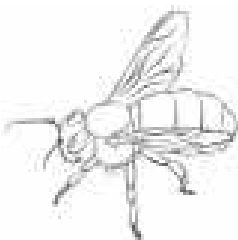
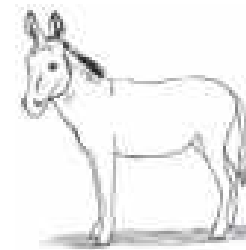
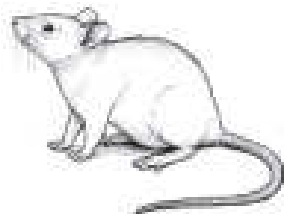

Yatiqatasatha amuykipapxañäni

5. Kutt'ayma.

- Arunakaxa sallanakaniwa. ¿Kunjamsa yatiqthanxa?

Yapu yäqaña tuqitha ullapxañäni qillqapxarakiñäni

3 Laphi



Yatiqañataki wakichasipxañäni

1. Yatiqiri masinakamampi aruskipt'ma.

Manq'aniñatakixa
yapu tumpañoaxa
aski wakisiriwa.



Achuqanakaxa wali
ch'amaniñatakiwa
yanapt'itu.

Askipacha yatxatapxañäni

2. Inti wawaxa, Maya wawaru jamuqanaka tuqitha jank'aki arsama, siwa; ch'iqatha kupi tuqiru jani maysa armasisa, siwa.

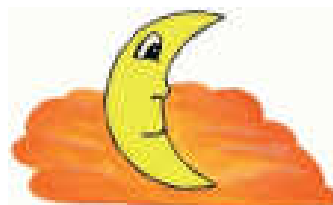
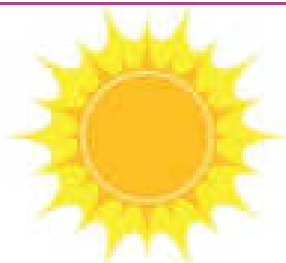

3. Yatiqiri masinakamana arsutaparjama qhipa sallapa qalltiri arunaka sañaru anatapxañäni.

Ch'uqi - qinaya - yapu - puruña...

Suma ist'äsina,
arunaka arsusa qhipa
sallaparjama arkasisa
anatt'apxañäni.



4. Arunaka taypiru kikipapa sallaniki uka arst'ma.

Akhama: apilla ➔ apiri

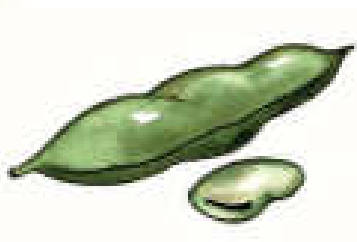

jawasa



siwara



jiwra



awayu



tawri



Llamayuña tuqi lajra
chinjanaka ullt'ama.

5. Laxra chinjanaka ist'ma, yatiqt'ma, ukhama k'ataki arst'ma.

Yapu yapuchawjana,
yapu yapuchañataki
yapu yapuchirinakaxa
yapu yapuchapxatayna.



Ch'uqi llamayuri saräsina
ch'uqi llamayurixa,
ch'uqi llamayuwsina qhiparäsinxaxa,
ch'uqi llamayurixa qatatiasitaynawa.

Jichhaxa yatichirimampi
ukhamarusa yatiqiri
masinakamampi mä
laxra chinja qillat'ma.



6. Janira qillqkasa, arst'asa jaysma.

¿Kunsa qillqajasti?

¿Kunatakisa qillqajasti?

¿Khititakisa qillqajasti?

7. Yatichirimampi ukhamarusa yatiqiri masinakamampi laxra chinja qillqapkta uka qillqama, ukatha sixst'arakma.

Handwriting practice area with a large yellow box for drawing and a set of blue dashed lines for writing.

Yatiqiri
masinakamampi
laxra chinjanaka
walja kuti
ukhamarusa
ratuki sañaru
anatapxañäni.



Yatiqatasatha amuykipappxañäni

8. Jaysma: ¿Laxra chinjanaka kunjamathsa yatiqawthanxa?

Yatikipasipxañäni

4 Laphi



Yatiqañataki wakichasipxañäni

1. Wilamasinakasampi jani ukjaxa yatiqiri masinakasampi jamuqa uñxatasa, ukatha aruskipapxañäni.

- ¿Kunsa uñch'ukisipki?
- ¿Kunathsa jaqinakaxa ch'uqi ali murmunk'uña tukuyxi ukxa uñxatapxi llamayuñaataki?
- ¿Kuna yaqha lumasankasa llamayuñaataki unch'ukitaxa?



Askipacha yatxatapxañäni

2. Wilamasinakamampi yatiqiri masinakamampisa aruskipt'awäsina, kuntixa chuqi llamayuña lumasatha amuykta, uka sixst'ma.

Ch'uqi ali murmunk'uña tukuyxi ukjaxa jank'aki llamayuri sarañawa, jani ukjaxa ch'uqixa laq'untxasphawa.





¡LLamaykthana uka
arunakampi anatañäni!

3. Janira aruskipkasa, jamuqa uñxatma.



4. Yatiqiri masinakamampi aruskipt'ma.

- ¿Jamuqana kuna arunakasa utji?
- ¿Philipi tataxa kunathsa sixa ¡Qhachx! ¿Kamsañsa munixa?
- ¿Kamsañsa munixa "sux sux"?
- ¿Jaqinakathsa ukhamarusa yänakathsa uka sallanaka ist'iritati? Qhananchma.

5. Jays't'ma, ¿Kuna sallanaksa ist'ayasispha?

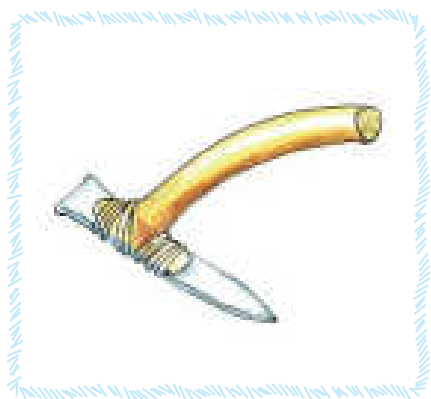

Yänakana sallanakapa yatisna walja kuti jisma. Sapa salla qhanpacha arst'añkama.



6. Paya yänakana sallanakapa yatisina sixst'ma ukatha qillqst'arakma.

Handwriting practice area with five horizontal dashed lines for writing.



Yatiqatasatha amuykipapxañäni

7. Jaysma.

- ¿Taqpacha yänakati sallanipacha?
- ¿Kunjamsa yatismasti?
- ¿Yapunxa kuna sallanaksa ist'apthanxa?



5 Laphi

Lurataja uñt'ayaja

Yatiqañataki wakichasipxañäni

¿Yapuna juk'a achuki
utjiphanxa, kunarusa
puriychistaspha uka tuqitha
qhanancht'aña munasmati?



¡Achuqanaka
juk'akixi uka tuqitha
qhananchapxañäni!

Askipacha yatxatapxañäni

1. Janira qhananchkasa, suma amuyunakamarjama qillqst'ma.

Handwriting practice area with ten horizontal dashed lines.

2. Jichhaxa, qillqatamarjama sixst'ma.



3. Achuqanakaxa juk'akixaspha ukjaxa kunarusa puriyistaspha, ukxata sixsutamampi qillqatamampitha wilamasimarusu yatiqiri masimarusu qhananchma.

Yatiqiri masinakamana
jiskht'anakaparu jaysañataki aski
ist'ma.



Yatiqatasatha amuykipapxañäni

4. Arsuwimpi jaysma:

- ¿Yapunakana achuqanakapaxa kunanakathsa pisipachakixi, uka uñt'ayañaxa wakispachati?

Jisa

Janiwa

- ¿Kunathsa?



6 Laphi

Yine jaqinakana chuqupa apsupxatapa tuqitha aruskipapxañäni

Yatiqañataki wakichasipxañäni

1. P'iqinchapa ullt'ma ukatha jisktt'akaru jaysma:

- ¿Qillqatanxa Kuna tuqithsa yatiyistani? ¿Kawksa tuqithsa yatiyistani?

Askipacha yatxatapxañäni

2. Ullart'apxañäni ukathxa aski amuyunaka chimpuntma.

Chuqupa achu apthapiwi

Jusiyaxa Yine ayllutawa, achachilapampi utjasisina, yapu tuqitha wali yatiñanaka yatiqäna. ukathxa chuqupa achu wali achuqañapatakixa jupaxa: "Chiri chiriwa Juliyu phaxsina utapa muych'ukisa warurt'i. Ukaxa chuqupa achuqaxa wali khusañapatakixa" sapxiwa.



Ukhamarusa, jupaxa chuqupa apthapiri sarki ukjaxa, nayriiri ali jik'sutampi achunaka wali khusa apthapiñatakixa art'asiña yafina: "Mapowaa, mapowaa, mapowaa"- sasa. Ukathwa apthapxäna.

Ukhamarusa Jusiyaxa wawanakaparusa jichhakamasa yatichaskakiwa.



3. Qillqata wasitatha ullawsina jiskht'anakaru jaysapxañäni.

- ¿Jusiyaxa kunjmathsa yafina yapupa askiñapatakixa?
- ¿Kamsañsa munixa "warurt'i" ukaxa?
- ¿Jusiyaxa kunatakisa wawanakaparu yatiñanakapa yatichaskakpacha?

4. Jiskht'anakaru jaysma ukatha kutt'ayawima chimpuntma.

- ¿Qillqatanxa kuna achuqatsa yatisixa?

Ch'uqitha

Chuqupatha

Jawasatha

- ¿Kunathsa Jusiyaxa nayraqatha apsuta aliruxa arxaypachäna?

Manq'añataki.

Jallu jawsañataki.

Wali khusa
apthapiñataki.

5. ¿Kawkiri jamuqasa yatiychistaspha: "Chuqupa achuqaxa wali khust'atawa" sasa?



Yatiqatanakasatha amuykipapkañani

6. ¿Yine uksaxana chuqupana achuqayatapaxa khusataynati?

7. ¿Yine aylluna ukhamasa ayllumana yatiwinakapaxa kikipati?



¡Anatapxañäni!

Sapa jamuqana sutipa arasma ukatha qhipa sallapa ist'äsina, uka pachpa sallampi qalltiri llip'iyañä jamuqa thaqma, akiri 361 jakhuni laphitha, ukatha wakisiriwjaru llip'katayma.

ch'uqi

lijwana

jawasa

awayu

apilla

kustala

ulluku

piku

3ri

T'aqa

Juyphina kamachinakapa



¿Kunjamsa achunaka aski imasipsnaxa?



Askipacha wakisiri utjirinaka:

Jichha pachanakana markachirinakaxa wilamasinakapa manq'aniñapataki achuqanaka mayjt'ayapxiwa. Juyphiru ch'uñupxi, lupiru wañsuyapxi ukhamawa, janikiwa yatiwinaka yäqaxapxkiti. Ukathpi chuñusa, tuntasa mayjakixiwa, janiwa aski sumäxiti.

Ukxa alxañatakikiwa kunjamsa marka tuqi apayxapxi, markathxa jani chani manq'anakaki alasinxapxaraki.

Uñxatma ukatha kutt'ayma:

1. ¿Jamuqankiri jaqinakaxa kunsalurasipki?
2. ¿Ukhama lurawinxayanapiritati? Aruskipma.



Ch'amt'añasa:

¿Kamachapsnasa wilamasisana achunaka aski wakichasipxañapa imañatakixa?

Lursuña: Mayjt'ayata achuqanakaxa kunathsa pisi sumakixi uka tuqitha qillsma, ukhama sixsma.

Juyphimpi mayjt'ayata achunakatha yatxatapxañäni

1 Laphi



Yatiqañataki wakichasipxañäni

1. Wilamasinakamampi yatiqiri masinakamampisa aruskipma.



¿Kunathsa mayjt'ayata
achuqanaka aski
manq'añataki jani
jakipxsnasti?

Askipacha yatxatapxañäni

2. Ch'uñu ch'uñuchañatha ullt'apxañäni.

Ch'uñu ch'uñuchaña

Maya jayp'uwa, Juliku achachilaxa Isakumpi, Katimpi allchhinakaparu, luraña tuqitha yatiyäna:



ch'uñu

“Nayra pachanakanxa jaqinakaxa juyphi wali sank'añapatakixa qutu warawara uñch'ukipxiřina, uka warawarana sarawiparjamawa kunaymana kasta ch'uqinaka tilatatañaxa”, sasa.



“Ukathpi aski imapxiřina, wilamasinakapa marpacha manq'asipxañapataki, jani ukhamiphanxa pisi manq'aniwa uñjasipxasphaxa. Kikiparakiwa



kaya

manq'asa  apilla achuthwa juyphimpi kiptayañaraki. Akiri manq'anakaxa wawanakaru k'umara jilaña yanaparaxixa”, sasa.

- ¿Kuna tuqithsa qillqatanxa yatiyistu?
- ¿Kunathsa p'iqinchapaxa "Ch'uñu ch'uñuchaña" sispacha?
- ¿Kunathsa juyphimpi mayjt'ayata achunakaxa jani aski luratäxi? Uka tuqitha qillqat'ma.

4. Chiqapa kutt'ayawi (X) chimpuntma.

- ¿Juyphi sank'añapataki kunsä uñch'ukipxirinaxa?

Qutu warawara.

Quta thaya.

- ¿Kuntakisa ch'uqi ch'uñuchapxäna?

Ch'uqi qhatjayañataki.

Marpacha manq'aniñataki.

5. Qillaqatana kawkiri manq'atanakathsa yatiychistu ukirinaka muyuntayma.



ch'uñu



kaya



jawasa

6. Wilamasimampi aruskipma juyphimpi mayjt'ayata manq'anakaxa kunathsa jani aski luratäxi uka tuqitha yatxatma.
7. Wilamasimaxa kunti juyphimpi mayjt'ayata manq'anakatha yatiyktama uka sixst'ma ukatha qillqarakma.

Handwriting practice area with four dashed lines on the left and a yellow sticky note on the right with a pencil icon.

8. Yatiqiri masinakamaru jani ukjaxa wilamasinakamarusa qillqt'atama kikiparaki sixst'atamsa yatikipayma.

Yatiqatasatha amuykipapxañäni

9. Jiskht'anaka ullawasina jaysawima samichma.

- ¿Markachirinakatakixa juyphimpi mayjt'ayata manq'anakaxa wakisiriti?

Jisa



Janiwa



- ¿Kunthsa?



2 Laphi

Ch'uñutha kayampitha ullapxañäni, qillqapxarakiñäni



Yatiqañataki wakichasipxañäni



1. Tatamaru jani ukaxa achachilamarusa, kunjamasa ch'uñu kikiparaki kaya uka lurawinaka tuqitha jiskht'ma. Sapktama ukarjama sixst'ma.





Askipacha yatxatapxañäni

2. Ch'uñutha kayampitha qillq'ata ullapxañäni.

Ch'uñu  manq'asaxa  ch'uqitha luratawa, samipasa ch'umpitha ch'iyararu tukutawa, chulluchataxa aliqa k'allkupuniwa, walja q'atawiniwa ukhamasa yurunirakiwa. Phutitaxa kuna manq'ampi manq'añasa wali sumawa.

Kikiparaki  kaya manq'axa  apillata juyphimpi kiptayatawa, ch'umpi saminiwa, kaya manq'irinakaxa wali k'umarapxi ukhamarusa ch'amanipxiwa.

 ch'uñu ukhamarusa  kaya manq'anakaxa kawkinti juyphi kikipasa walja lupi utjki uka chiqanwa lurasiraki ukhamatha mach'a pachanakansa wilamasinakaxa manq'apxarakiwa.

Ukathapi, khitinakatixa jani lurapkixa jani manq'aniwa uñjasipxaraki.



3. Jiskht'anakaru arsuwimpi kutt'ayma.

- ¿Qillqatanxa kawkiri manq'anakathsa yatiyistu?
- ¿Ch'uñumpi kayampixa kunathsa pisipachakixi?

4. Juyphimpi kiptayata manq'anakana sutinakapa samichma.

ch'uñu	<i>ch'uñu</i>	<i>ch'uxu</i>	CH'UÑU	ch'uch'u
kaya	KAYA	<i>kuka</i>	kayu	kaya

Inti wawaxa awichaparu tumpiriwa saratayna, ukanxa: ch'uñu phuti, kaya phuti, munta qhati, aychampi ukhama suma manq'apxäna, jichhaxa sutinakapa jakiyaña ukhamarusa amuyunaka phuqachaña yanapma.





5. Ch'uñu ukhamaraki kaya kikipa aski qillqatanakaru muyuntayma.



ch'uñu	ch'uxu	ch'uch'u	kayu	kaya	kuka
--------	--------	----------	------	------	------

6. Jichhaxa, ch'uñu – kaya uka aru jakitanakampi amuyuru phuqachma.

Juliku tataxa  _____ uñxatäsina, askixiwa apthapiñataki sänawa

Niyasa  _____ manq'axa wañsuñapäskiwa, imxañataki, sasa.

Maya wawaxa, kiptayata manq'anakana sutinakapa jaljayañaruwa anataña muni, tarjita qillqatanakampi aru qillqata apnaqañanakampi yanapma.



7. Jamuqanaka uñxatasa sutinakapa ullt'ma. Arunakana sapa sallaparjama muyunakaru samichma, ukathxa kajunallanakaru aru jaljayata qillqma.



ch'uñu

○	○	○



kaya

○	○	○

8. Jichhaxa manq'anakana sutipa ukhamarusa aru jaljtayatanakampi ullt'ma ukhama wakisirirjama tupayma.



ka	ya
----	----

CH'UÑU



ch'u	ñu
------	----

KAYA

¡Manq'anakana sutinakapa uñt'añaxa khusawa!



Inti wawaxa, juyphina kiptayata achunakana sutinakapa qillqata uñt'aña muni, qillqata aru apnaqañanakampi uka wakichataru phuqachma.



9. Manq'anakana sutipa ulltapxañäni, ukathxa sapa salla jaljayañäni.



 **Ch'uñu**

--	--	--	--	--	--	--

 **kaya**

--	--	--	--	--	--	--

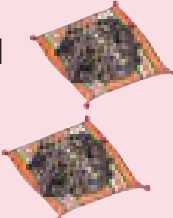
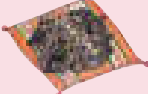
10. Juyphimpi mayjt'ayata manq'anakana sutinakapa qillqäsina phuqachma.

Inti wawaxa awkiparu  _____ takiña, ukhamarusa  _____ wañsuyäsina apthapiñsa yanapäna. Uka muxsa  _____ manq'axa apillatha luratawa kikiparaki  _____ ukasa ch'uqitha juyphimpi kiptayatarakiwa.

Yatiqatasatha amuykipapaxañäni

11. ¿Kuna lurawinakasa khusänasti? ¿Kunathsa?

12. Wilamasinakamampi uñt'ata manq'anakana sutinakapa qillqañataki aruskipma.



3 Laphi

Ch'uñu ch'uñuñampitha kaya kayañampitha ullapxañäni, qillqt'apxarakiñäni

Yatiqañasataki wakichasipxañäni

Ch'uñu, kaya lurasiwipatha yatxatapxañäni. ¿Kunsa uka manq'anakatha yatipxthanxa?



Askipacha yatxatapxañäni

1. Janira qillqata ullkasa, jaysma.

¿Kunatakisa qillqata ullapxañäni?

¿Kuna yatiwinaksa yatxatapxpachañäni?

2. Akiri qillqata ch'ujuki ull'ta, ukathxa uñ'ta arunakaru muyuntayma.

Ch'uñumpi kayampi

Ch'uñuxa  ch'uqitha luratawa, ukatakixa lumasanaka uñch'ukisa juyphi pachawa suyaña. Ch'uñuchañatakixa sujsthapiwa ch'uqixa tilatatäsina umampi ch'allakipt'asa apanukuña.



Kaya lurañatakixa,



apillaxa pusi urüwa qawichaña, ukatha

qawichatathxa kimsa arumarakiwa juyphiru apanukuña, ukataraki kayumpi p'altjaña, wañsxiapanxa imxañarakiñawa. Ukhama uka juphimpipi mayjt'ayatha mañq'anakaxa lurasia, ukhamatha marpacha manq'aniñataki.

3. “Ch’uñumpitha kayampitha” qillqata ulläsina, arst’asa jaysma.

- ¿Kunathsa ch’uñumpi kayampixa juyphimpi lurası?
- ¿Kunathsa jani wakisiri manq’anaka manq’apxpachathansti?

4. Chiqapa kuff’ayawi chimpuntma:

- ¿Kayaru mayjt’ayañataki qhawqha arumasa juyphiru apanukuña?



1

2

3

Maya wawaru juyphimpi mayjt’ayata manq’anakana sutinakapa qillqaña yanapma, apnaqaña qillqanakampi.

5. Uñ’ata arunaka qillapxañäni

a p n a q a ñ a

a i l l a n a k a

ukampi





Jichhaxa amuyuru phuqachapxañäni.



_____ ukhamaraki



_____ uka

manq’anakaxa marpachatakiwa, jani ukhamäkaspaha ukjaxa janiwa aski ch’amanchasiri manq’anaka manq’atäxsnati.



Inti wawaxa, aru jaljayatanakxa janiwa katjkiti, ¡Yanapt'ma!



6. Manq'anakana sutipa aru jaljayatapampi tupayma.

ch'uñu

ka

ya

kaya

ñu

ch'u

7. Akiri arunakatha kawkirinakatixa manq'anaka sutiniki ukanaka, (X) chimpuntma.

kayu

kaya

kawuya

kuka

ch'uñu

ch'uxu

ch'uqi

ch'uch'u



Maya wawaxa juyphimpi mayjt'ayata manq'anakana sutipa qillqt'aña muni. ¡Yanapipxañäni!

8. Sapa arutha aru jaljayatanakapa pachpa samimpi samichma ukatha tupayarakma.

ch'uñu

ch'u

ñu

ka

ya

kaya

9. Qillaqata arunakampi  ch'uñu  kaya, yaqha aru jaljatanaka wakiyañaru anatapxañäni, ukhama jaqha arunaka jakiñataki.

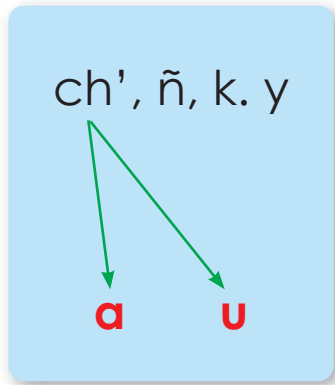

ch'a		ach'	
	ñu	uñ	
ya		ay	

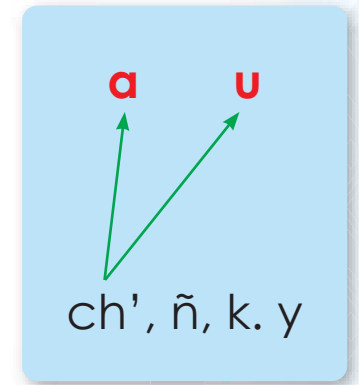

10. Arunakaru uñt'ata aru jaljayatampi phuqachañäni.

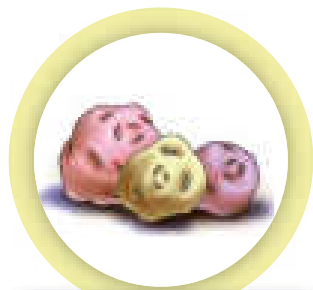

___ qi



ka ___

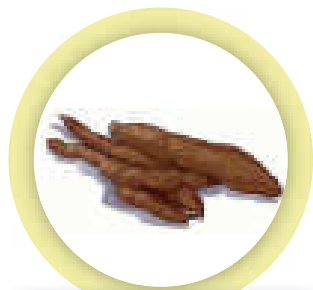

yu ___

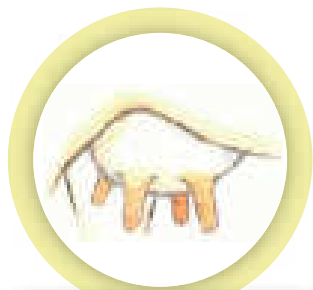

___ ñu



___ ka



___ pu



___ llu



ku ___

Uka arunakampi amuyunaka qillqat'apxañäni.



Yatiqatasatha amuykipapaxañäni

11. ¿Kuna arunaksa yatiqawthana? ¿Kunjamasas?

12. Wilamasinakamampi juyphimpi mayjt'ayata manq'anaxata aruskipma, qillqat'añataki ukhamaraki sixsuñataki.



4 Laphi

Yatikipayasipxañäni

Yatiqañataki wakichasipxañäni

1. Jamuqa uñxatasa jiskt'anakaru jaysma.

- ¿Kunsa jaqinakaxa unch'ukisipkixa?
- ¿Kunsa qutu warawaxa yatiychistu?
- ¿Jaqinakaxa kunapachasa ch'uqi tilatatapxpachani ch'uñuchañatakixa?



Askipacha yatxatapxañäni

2. Wilamasinakamampi ukatha yatiqiri masinakamampi lumanakatha yatiñasataki kuna pachasa walixa aski juyphi sank'añapatakixa uka tuqita aruskipañäni, kuntixa yatiyaptama uka qillqama.

3. Yatiri tataxa kamsistusa uka tuqitha ullapxañani.



Qutu warawara uñst'ani
ukaxa juyphina wali
sank'añapa yatiyasi,
wakisxiwa ch'uñu lurañaxa.



4. Jichhaxa juyphimpi mayjt'ayata manq'anaka ch'amanchayapkchistu, uka tuqitha yatiyapxañani.

5. Janira yatiykasa, yatiqiri masinakamampi juyphimpi mayjt'ayata achunakatha aruskipma, askipacha wali uñt'atamatha.

¿Kawkiri juyphimpi mayjt'ayata
manq'anaksa unt'taxa?

¿kawkchhapirisa
yatiyañataki ajllisma?

¿Kawkhimäpachasa?

6. Juyphimpi mayjt'ayata manq'a ajllitamatha sixst'ma.

7. Yatiqiri masinakamampi uruskipañataki qutuchasipxma, ukatha akiri wakichatarjama arkma.

¿Kunjamasa manq'axa juyphimpi mayjt'ayataxa?

¿Kawkinsa lurası?

¿Kunjamasa mallt'atasti?

¿Kunathsa uka ajlltha?

Maya juyphimpi mayjt'ayata manq'aña sixsma ukatha uñanchayma.



Jach'atha wali qhana arsuña jani armamti.

8. Yatiqiri masinakamana uñt'ayawinakapa aski isch'ukma.

9. Kunapachatixa juyphimpi mayjt'ayata manq'a ajllitama uñakipataxäni ukatha, luratanakama samichma.

Jach'atha qhana arumpi manq'anakatha yatiyawthxa.

Yatiqiri masinakajana uñt'ayawinakapa tuqi aski ist'awtha.

Jiskht'awinaka wakichawtha

Yatiqatasatha amuykipapxañäni

10. Arst'asa jaysapxañäni.

- ¿Juyphi sank'awi lumasanakatha yatiñaxa wakisiriti? ¿Kunathsa?

Lurataja uñt'ayaja

5 Laphi



Yatqañataki wakichasipxañäni

¿Kunjamsa juyphimpi
mayjt'ayatäski achuqanaka
imañatakixa, uka wilamasinakamaru
kikiparaki qillqa wakichapxañäni
yatiyaña muntati?



¡Maya qillqa
wakichapxañäni!

Askipacha yatxatapxañäni

1. Janira qillqasa, jamuqanaka uñakipma, ukatha sapaqata lurawi unt'ayma.



2. Qillqat'añataki wakichasipxañäni:

¿Kunsa qillqañänixa?	¿Kuna tuqithäpachanisa?	¿Khititakisa qillqañänixa?

3. Kunanakathsa juyphimpi kiptayata manq'anaka jani aski sumäxi uka tuqitha qillqma.

4. Yatiqiri masimaru jani ukjaxa wilamasimarusu qillqt'atama yatiyma ukhamarusu kuna amuyunaksa askiñapataki katuqma.

Yatiqatasatha amuykipapaxañäni

5. Arst'asa jaysma: ¿Jumataki uka lurawinxu kunasa khusänxa? ¿Kunathsa?



Wilamasinakamaru ukhamaraki yatiqiri masinakamarusa qillqt'atama yatiyma.

Ika markana jaqinakaxa kunjamsa imañataki ch'uqi achuqxa majt'ayapxpacha, uka tuqitha yatxatapxañäni

6 Laphi



Yatiqañataki wakichasipxañäni

1. Janira qillqa ullt'kasa, jaysma.

- ¿Kunathsa qillqataxa yatiypachistani? ¿Ica tuqina ch'uqi achuqa imañataki mayjt'ayañaxa kunjamäpachasa?

Askipacha yatxatapxañäni

2. Qillqata ullt'apxañäni.

Ika markana ch'uqi wañsuyata

Khaysa Ika markanxa ch'uqxa phaysüsina, sillp'süsina, q'allunuqäsina lupimpiwa wañsuyapxixa, ukhamawa waña ch'uqi apnaqapxixa.

Uka lurawimpixa ch'uqi walja phaxsinakasa, marpachasa imasisksnawa. Ukhamasa, uka wañsuyata manq'anakaxa jasakiwa imañasa ukhamaraki apnaqañasa.

Ukhamarakiwa uka wañsuyata ch'uqitha phayapxaraki karapulkra manq'a, wali sumarakiwa ukxa manqt'asipxi.



3. Akiri jiskt'awitha, yatiqiri masinakamampi aruskipma:

- ¿Kunathsa lka tuqinxä ch'uqi wañsuyapxpacha?

4. lka uksaxäna kunjamsa ch'uqi mayjt'ayapxi imañataki, uka tuqitha sixst'ma.

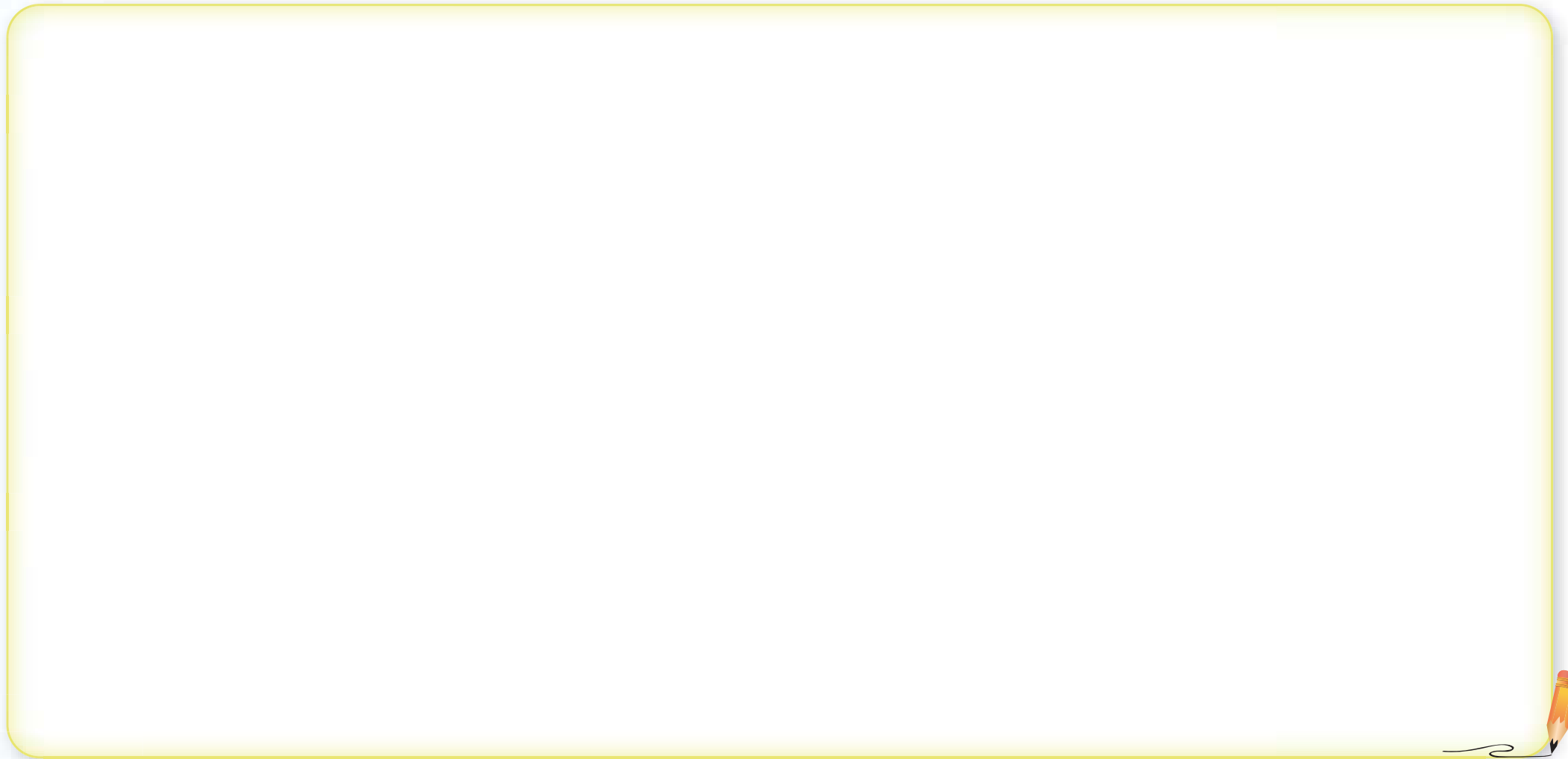

Yatiqatasatha amuykipapaxañäni

5. ¿lka markana ch'uqi wañsuyapxi ukaxa askiti jumataki? ¿Kunathsa?

6. ¿lka markana ch'uqi mayjt'ayapki, ukhamarusa ayllumana ch'uqi mayjt'ayapki ukampixa, kuna lurawisa kikipakixa?

¿Kunathsa mayjt'ayata achunakaxa jani askixi?



Aski wakisiri utjirinaka:

Jichha pachanakanxa, juyphimpi kiptayata manq'anakaxa janikiwa nayrjama sumäxiti jisnawa: ch'uñu, kaya, tunta, ch'arki yaqhanakampisa. Yaqhipa jaqinakaxa janikiwa uka manq'anaka lurañsa amtaxpxarakiti. Kunathtixa uka achunaka mayjt'ayañatakixa lumasana janikiwa yäqxapxiti.



Juyphimpi mayjt'ayata manq'anakatha yatxatawasina, jichhaxa jaqha ch'amt'añasa phuqapxañäni:

¿Kunsa kamachasnaxa juyphimpi mayjt'ayata manq'anaka pisikipunixaspha ukjaxa kunarusa purt'asnaxa, uka tuqitha yatxatañatakixa?

Lursuña: Juyphimpi mayjt'ayata manq'anaka tuqitha qillqt'apxañäni.



1 Laphi

Juyphimpi mayjt'ayata manq'anaka juk'akixaspha ukjaxa kamachasphasa uka tuqitha yatiqthana

Yatiqañataki wakichasipxañäni

1. Wilamasinakamampi ukhamaraki yatiqiri masinakamampisa aruskipma.



¿Kamachasphasa jani juyphimpi mayjt'ayata manq'anaka utjkaspha ukjaxa?

Askipacha yatxatapxañäni

2. Akiri qillqata ullt'ma.

¡Ist'apxañäni!

Maya jayp'uxa, Irma mamaxa  **isañu** qhatiyäsina juyphiru

asanuqatayna, qhipa uruxa  **thayacha** wali muxsa

wawanakapampi manq'apxäna.

Qhipa arumanthitakixa chayru phayaña amtänaxa; ukatha janiwa ch'uñuxa utjxataynati, ukhamiphana jach'a arutha –¡Ch'uñuwa tukusita! ¡Jichhaxa kamachiñänisa! – sasawa art'asina.

Isañusa thayacha lurañataki ch'uqisa ch'uñu ch'uñuñataki tukusxänawa, jani kuna manq'añaniwa uñjasxapxäna.



Kunarusu purt'assna juyphimpi mayjt'ayata manq'anaka pisipxaspha ukjaxa, uka tuqitha aruskipma.



3. Jiskht'awinaku arsuwimpi kutt'ayañäni.

- ¿kunathsa Irma mamaxa isañu juyphiru apanuqpachäna?
- ¿Kunathsa Irma mamaxa sispachäna: “¡Ch'uñuwa tukusita!” sasaxa?
- ¿Kamachasphasa jani khitisa ch'uqxa juyphimpi mayjt'ayapkaspha ukjaxa?

4. Qillqatarjama: ¿Kamachasphasa juyphimpi mayjt'ayata manq'anakaxa juk'akixaspha ukjaxa? Uka tuqitha qillqt'ma.

5. Kutt'ayawima chimpuntma:

- ¿Kamachasphasa jani aski manq'asksna ukjaxa?

Usuntsnawa

Ch'amanisnawa

6. Jamuqanakana sutipampi tupayma.

Qillqatana mayjt'ayata manq'anakana sutinchatanaka jamuqanakapampi tupayma.

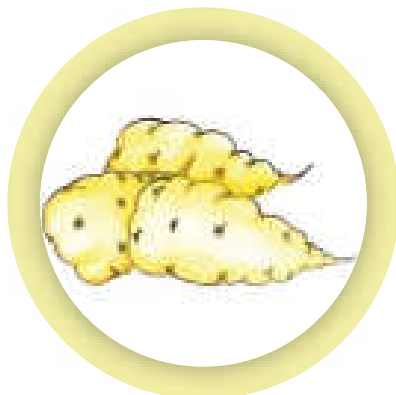

isañu

thayacha

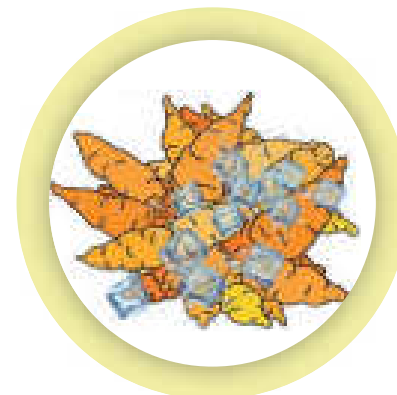

7. Wilamasinakamampi, juyphimpi mayjt'ayata manq'anakaxa kunathsa jani askixi uka tuqitha yatxatma.
8. Wilamasimaru juyphimpi mayjt'ayata achunaqxata jiskht'ma, ukatha sixst'ma, ukhamarusa qillqt'arakma.

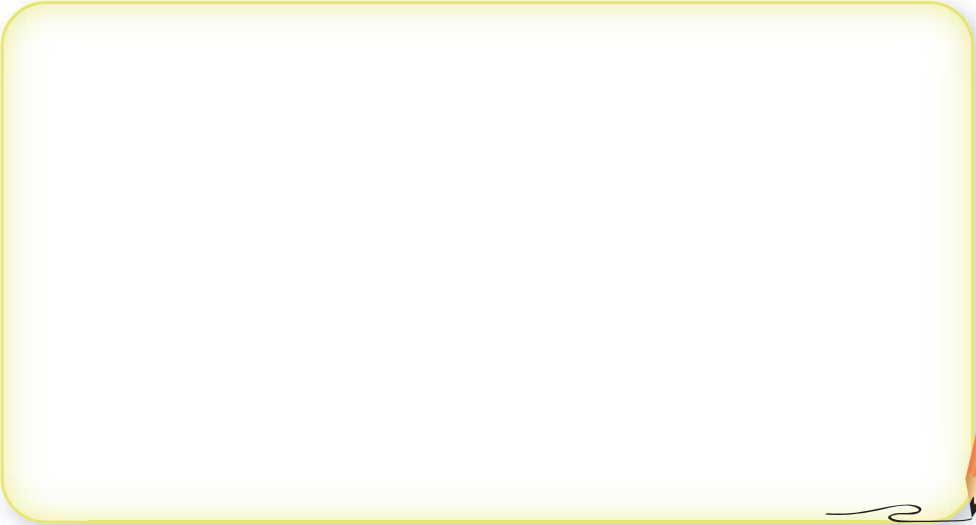

9. Masinakamampi jani ukjaxa wilamasimampisa qillqatama kikiparaki sixsutama yatikipayma.

Yatiqatasatha amuykipapxañäni

10. Jiskht'awi ullma ukatha kutt'ayawima (X) chimpuntma.

• ¿Juyphimpi mayjt'ayata manq'anakatha yatiñaxa wakisiti?

Jisa

Janiwa

• ¿Kunathsa?

Isañu thayachxata ullt'apxañäni ukatha qillt'apxarakiñäni

2 Laphi



Yatiqañataki wakichasipxañäni

1. Irma mamaxa kunjamasa thayacha luratayna uka tuqitha aruskipma.



Kuntixa yatiyasi uka tuqitha sixst'ma.



Askipacha yatxatapxañäni

2. Qillqata ullma ukatha jaysma.

Thayachaxa qullarakiwa

Isañu qhati mä suma pañu patxaru jani ukjaxa mä p'axla llataruwa juyphi arumana apanuqañaxa.

Yaqhipa utjawinakanxa jichhu uta patxanakaruwa kuna wakisiri patxaru uskupxi. Ukatha qhipa qharaxa wali luxutwa aptxapxaraki.

Isañuxa kunaymana usunaka qullasiñatakiwa, yaqhipaxa chachanakana usupa qulliriwa sapxarakiwa. Ukathwa thayacha manq'apxixa, ukhamasa janchisataki wakisirinakaniwa ukathwa manq'añaxa.

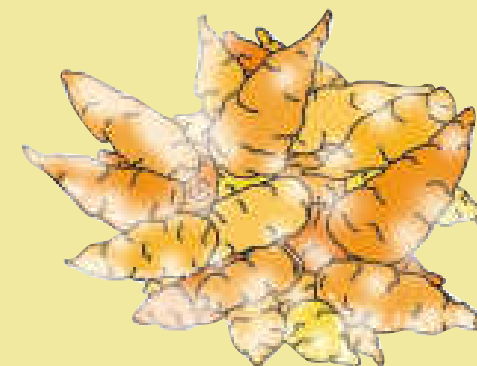

3. Arst'asa jiskht'anakaru jaysma.

- ¿Kuna tuqithsa qillqawinxá yatiychistu? ¿Kunjamasa?
- ¿Thatachaxa kunatakisa qullaxa?



Kiptayata manq'anakana
sutipawa chhaqi.
¡Thaqapxañäni!

4. Akiri sixsutanakana sutinakapampi tupayma ukatha samicharakma.



isañu



thayacha

5. "Isañu" ukhamaraki "thayacha" uka sutinaka samicht'ma.

isañu	sanu	isañu	istalla	isañu
thayacha	thaya	thayacha	thutha	thayacha

Maya wawaxa
manq'anakana
sutipa jaljayaña muni.
¡Yanapt'apxañäni!



6. Jamuqanaka uñxatasa uka arunaka ullma, ukhama sallaparjama jaljayasa muyunakaru samichma.

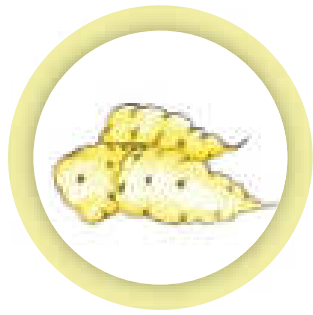

isañu

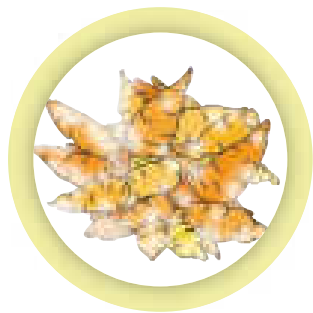
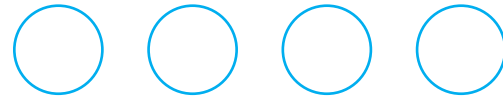

thayacha

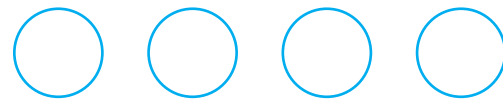

Ullatama aru qillqma.

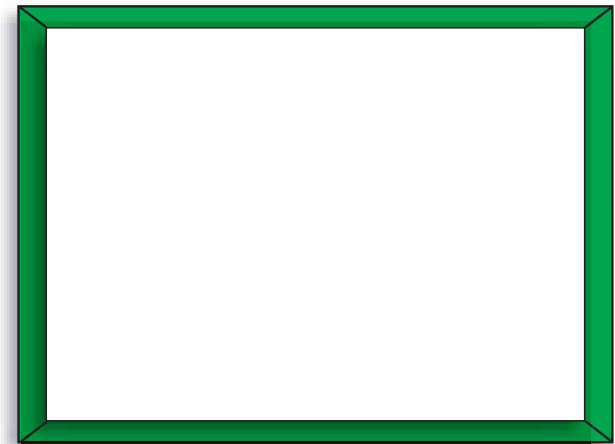
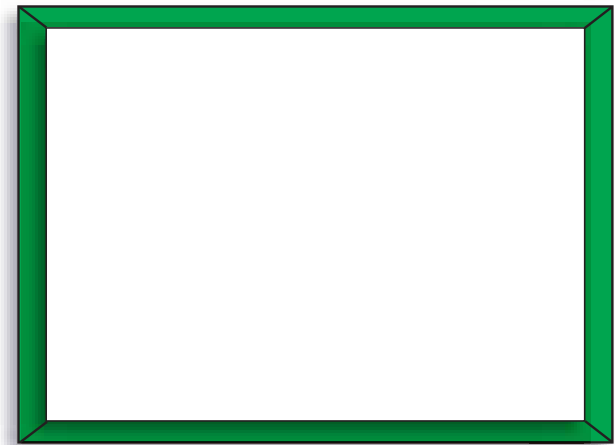

7. Akiri arunakampi amuyuru phuqachma:



_____ manq'axa aski qullawa ukhamarusa ch'amañchayasiriwa.



_____ wawanakana munkañña manq'apawa.



Kiptayata manq'anakana
sutipawa chhaqi.
¡Thaqapxañäni!

8. Manq'anakana sutipa ullma ukatha sapa salla jaljtayma.



isañu						
-------	--	--	--	--	--	--



thayacha						
----------	--	--	--	--	--	--

9. Qillqanaka uñxatma ukatha jamuqanakana sutinakaparjama ajllma.

i s th a ñ u y ch

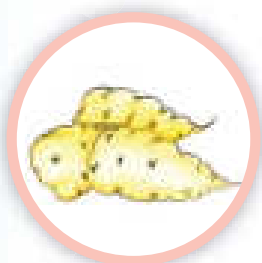

Yatiqatasatha amuykipapxañäni

10. ¿Kunsa juyphimpi mayjt'ayata manq'anaka tuqitha yatiqthana? ¿Kunjamsa yatiqtasti?

- Yaqha juyphimpi mayjt'ayata manq'anaka uñt'sta ukjaxa, ukanaka tuqitha yatiyarakma.

Jupyphimpi mayjt'ayata manq'anakatha ullapxañäni ukatha qillqapxarakiñäni

3 Laphi



Yatiqañataki wakichasipxañäni



¿Kunjamasä
isañu
thayachaxa?

Asakipacha yatxatapxañäni

1. Qillqata janira ullkasa, kutt'ayma:

¿Kunjamäpachasa thayacha
lurañasti?

¿Kunatakisa jaqinakaxa
thaqapxpacha?

2. Qillqata ch'ujuki ullt'ma, ukatha uñt'ata arunaka muyuntayma.

Isañu thayachatha

Isañuxa jiwasa suni suyu tuqina walja thaya taypinsa achuqiriwa, ñiya apilla kikipa wiskhalla achuqawa. Aski wakisirinakaniwa k'umarañätakiwa thaqataraki.

Uka achuqaxa qhatiyatasa jani ukjaxa thayachatasa suma manq'awa, yamastha qhatiyañatakixa lupiruwa qawichaña, kalturu phayasiñatakixa janiwa qawichañäkiti.

Thayachaxa wawanakatakisa wali muxsawa. Ukhamarusa uka manq'axa qullawa, ukathwa isañu achuruxa yäqañasa.



3. Qillqata ullawasina "Isañu thayachatha", arst'asa jaysma.

- ¿Kawksaxansa isañuxa achuxa? ¿Kunatakisa walipacha?
- ¿Aski wakisiriti isañu achuqañapaxa? ¿Kunathsa?
- ¿Suni suyu tuqixa askipachati jaqinaka utjasiñapatakixa? ¿Kunathsa?

4. Akiri wakichataru sutinakapampi phuqacht'ma.

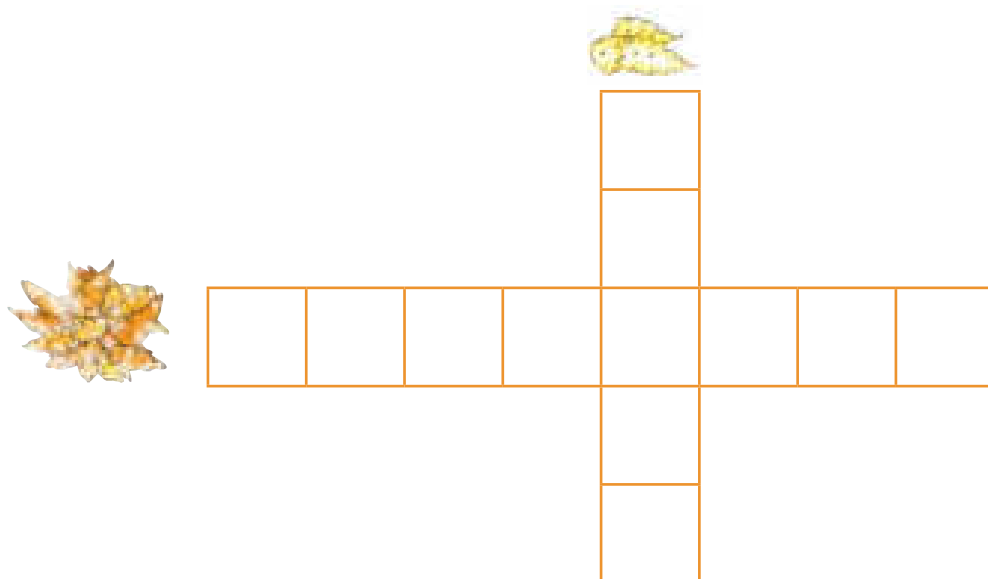

Isañu ukhamaraki
thayacha
ukanakatha
k'atampi
yatxatapxthana.



5. Qillqatanakaru phuqachma.



_____ xa k'allk'uwa ukhamarusa
janiwa ukhampacha manq'añäkiti.

_____ xa phayasiñatakixa lupiru
qawichañawa.



_____ xa wawanakana
misk'ipawa.

_____ xa isañu phutsüsina
juyphiru apanukusinwa lurasi.



Juyphi sank'añapa
yatiñatakixa qutu
warawarawa uñch'ukiñaxa.

6. Qillaqata arunakampi  ukatha , machaqa aru jaljatanaka wakiyañaru anapaxañani, ukhamatha yaqha arunaka jakiñataki.

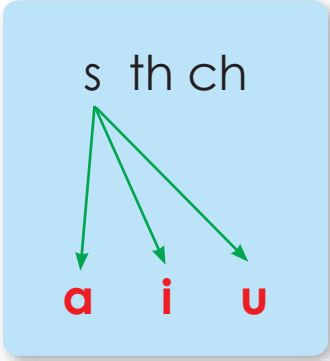

sa					us
	thi			uth	
		chu	ich		

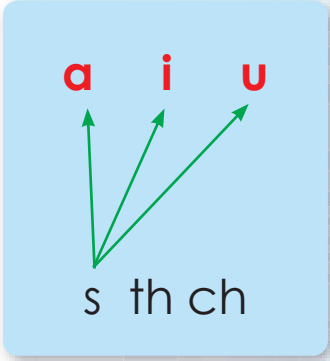

7. Arunakaru uñ'atha aru jaljayatampi phuqachañani yaqha machaqa arunaka kiptayañataki.



___ku



___ki



ku___ku___



ay___

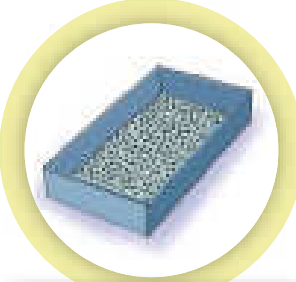

___su___



ki___



chu___





thu___

8. Tarjitanakana uka aru jaljayatanakampi jaqha arunaka wakiyma.

Apnaqaña qillqanaka
ajllisa arunaka
kiptayäsina qillqañäni.

9. Amuyunakaru phuqachapxañäni.

- Wawanakaxa  _____ musq'ayapxi.
- Awichaxa  _____ sawuski.
- Inti wawaxa  _____ phusaski.

Yatikipayasipxañäni

4 Laphi



Yatiqañataki wakichasipxañäni

1. Jamuqa uñxatma ukathxa jiskht'anakaru kutt'ayma.

- ¿Kampachasa ch'ulluni jamach'ixa?
- ¿Kunsa yatipacha ch'ulluni jamach'ixa?
- ¿Jaqinakaxa uka yatiyxa yäqapxachati? Aruskipt'ma.



Askipacha yatxatapxañäni

2. Yatiqiri masinamampi jani ukjaxa wilamasimampisa juyphi sank'aña lumanakatha aruskipt'ama, kunfi yatiyapktama uka tuqitha qillqt'ma.

3. Yatirixa kunt'i yatiyapktama uka ullt'apxäni:



Juyphi wali sank'añapatakixa
ch'ulluni jamach'ixa ñiya chika
uruthpacha "Juyphiwa ch'isi"
sasawa ch'akiqixa.

4. Ch'uñuchañawja chiqawja uñt'apxañäni.



5. Janira uñt'kasa, yatiqiri masinakamampi uñt'ata chiqawjanakatha aruskipapxma.

¿Kawkhaxanaksa
uñt'apxthana?

¿Kawki tuqisa ajllismaxa
yatt'ayañataki?

¿Kunjamasa?

6. Ajllitama ukawja sixst'ma.

A large, empty yellow rectangular box with rounded corners, intended for writing or drawing. It occupies the lower half of the page.

7. Yatiqiri masinampi aruskipañataki qutuchasipxma ukatha akiri wakiyatarjama arkapxma.

¿Kunjamasa ukawja chiqaxa?

¿Kawksäxankisa?

¿Kunanakathsa jisqxattaxa?

¿Kunathsa uka chiqawja ajllta?

Ukawja utjasiwi tuqi mä jamuqa uñt'ayma, yatiyañataki.



Arsuñataki amuyunakama wakichma.

8. Yatiqiri masimana uñt'awinakapa aski isch'ukma.

9. Ukawja ajllitama uñt'ayäsina lurawinakama samichma.

Ukawja chiqa ajllitajatha askti yatiyawtha.

Jach'atha ukhamarusa qhanti arsuwaytha.

Yatiqiri masikakajana uñtt'atapatha yatiyawipa sumti ist'awaytha.

Yatiqatasatha amuykipapxañäni

10. Arst'asa jaysapxañäni:

- ¿Wakisiriti kunaymana chiqawjanakatha ukhamaraki ch'amanchasiri manq'anakatha mayninakaru uñt'ayañaxa? ¿Kunathsa? ¿Kunjamsa yatiqawaythxa?



5 Laphi

Lurataja uñt'ayaja

Yatiqañataki wakichasipxañäni

¿Juk'akispha juyphimpi kiptayata
manq'anakaxa ukatha
kunarusa purt'aysna uka tuqiha
wilamasinakamaru yatiyaña
munasmati?



¡Maya qillqa
qillqt'apxañäni!

Askipacha yatxatapxañäni

1. Janira qillqkasa, jamuqanaka uñakipma, ukatha sapaqata lurawi unt'ayma.



2. Qillqa wakichma.

¿Kunsa qillqañäni?	¿Kuna tuqithäpachanisa?	¿Khititakisa qillqañäni?

3. Kamachasphasa juyphimpi kiptayata manq'anaka pisipachakixaspha ukjasti, uka tuqi yatxatäsina qillqaqma.

Handwriting practice area with ten horizontal dashed lines for writing.

4. Yatiqiri masimaru jani ukjaxa wilamasimarusä qillqatama yatiyma, ukhamarusä askiñapataki kuna amuyunaksa katuqma.

Yatiqatasatha amuykipapxañäni

5. Arst'asa jaysma: ¿Jumataki uka lurawina kunasa wali khusänaxa? ¿Kunathsa?



Wilamasimaru
ukhamaraki yatiqiri
masimarusä qillqatama
yatiyma.



6 Laphi

Ch'arki luraña tuqitha yatiqthana

Yatiqañataki wakichasipxañäni

1. Qillqata janira ullkasa.

- ¿Kuna tuqitha qillqatäpachasa? ¿Kunasa kamachpachäni?

Askipacha yatxatapxañäni

2. Jichhaxa ull'apxañäni:

Ch'arkhiña

Ch'arkhixa janchisaru ch'amanchiriwa k'umara jakasiñataki, ukathwa kunaymana manq'anakana phayataxa.



Aychaxa jani utjki uka pachataki imañawa.



Allphachu,



uwija,



waka,

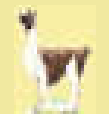

qawra aychanakathwa ch'arkhiña

khusaxa. Ch'arkhiñatakixa aychaxa

sillp'a sillp'awa kharinuqaña, ukathxa jayumpiwa jach'ikipaña, ukhamawa juyphiru apsuña, lupiruraki wañsuyaña, yaqhipaxa pä arumarakiwa juyphsuyapxi ukatha pä ururakiwa wañichapxi, ukhamawa imañaxa jallu pachataki.



3. Wilamasimampi jani ukjaxa yatiqiri masinakamampisa aruskipma, ukhama jiskht'anakaru kutt'ayma:

- ¿Kuna tuqithsa qillqataxa yatiychistu? ¿Kunatakisa ch'arki lurapxi?
- Ch'arki luraña tuqitha sixst'ma.

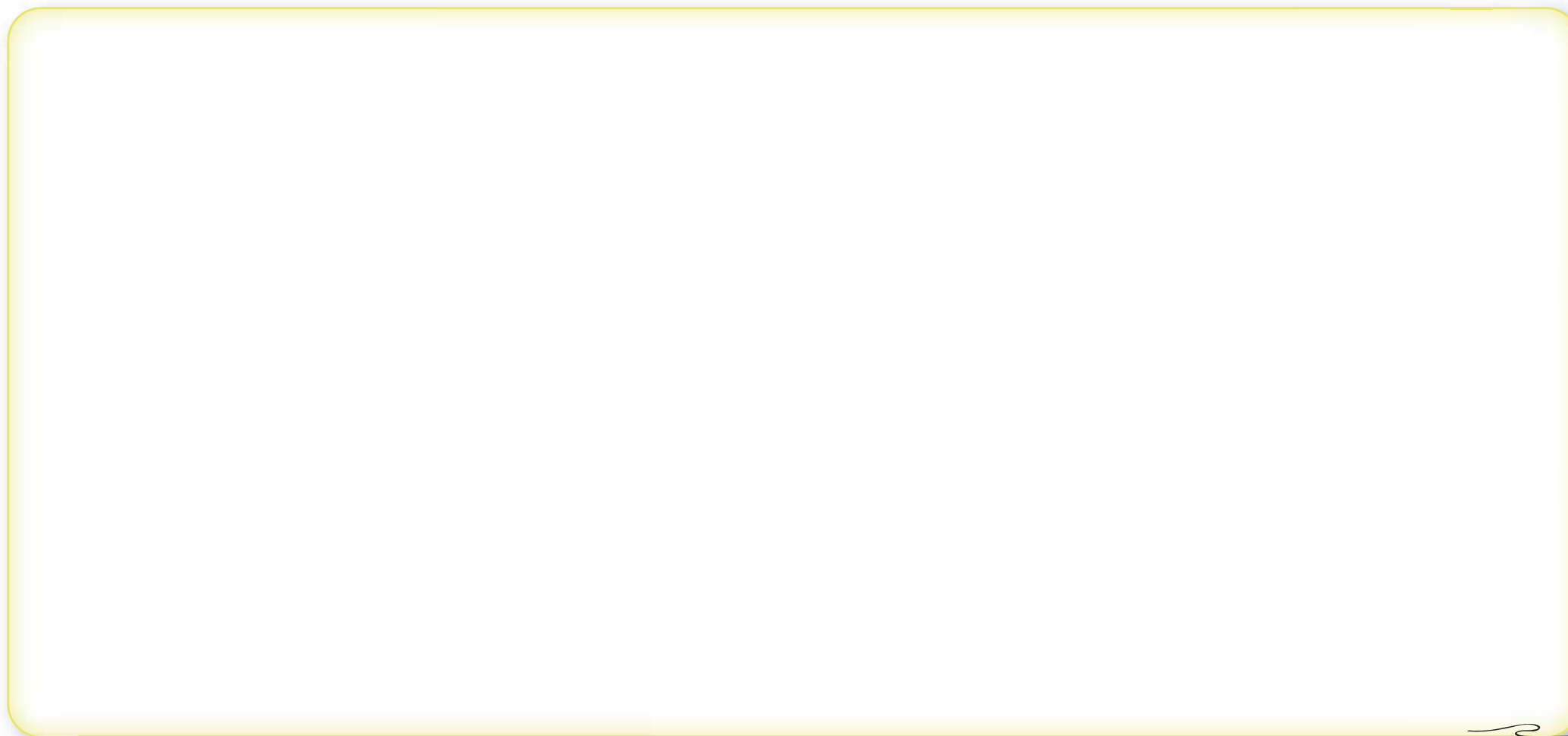

Yatiqatasatha amuykipapxañäni

- ¿Ch'arki luraña tuqitha yatiqawixa askipachati? ¿Kunathsa?
- ¿Jumana ayllumanxa ch'arkxa kikiparakti lurapxi? ¿Kunjamasa?



¡Anatapxañäni!

Jamuqanaka uñakipt'asa sutinchma. Ajllitama akiri 363 laphinkiri
llip'katayañanakampi salla qalltaparjama llip'katayma.

a

i

u

4ri
T'aqa

K'umarapxañasataki
isinaka wakichapxañäni



¿Kunathsa jiwasa p'itata isinakampi jani isixapxiti?



Aski wakisiri utjirinaka:

Ayllunakana p'itaña lurawinakaxa yatiña yatiñaniwa, ukanaka jani chhaqtañapataki jilirinakatha sullkanaka tuqiruwa luraña yatichapxirinaxa. Ukhama sipana, jaqinakasa jichhürunakana janikiwa p'itata isinaka uchasxapxiti, jaya markawkatha apanita isinakaki alasxapxi. Ukhamatha jiwasana p'itata isinakaxa pisipxakiwa.

Uñxatma ukhama kutt'ayma:

1. ¿Kunsa jaqinakaxa jamuqana lurasipki?
2. ¿Uka lurawi lurañana yanapiritati? Aruskipma.



Ch'amt'añasa:

¿Kunjamsa pisiki p'itata isinakampi isixatasatha yatxatäsina mayninakaru yatiysnaxa?

Lursuña: Ayllunakana kunjamasa isisipxthana uka tuqitha mä warurt'a qillqma.

Jiwasa p'itata isinakampi jani isixatasatha yatxatapxañäni

1 Laphi



Yatiqañataki wakichasipxañäni

1. Jiliri wilamasimampi, p'it'ata ch'ullu kunathsa awisphaki uchasxapxthana, uka tuqitha aruskipma. Ukhama sixst'ma.



Askipacha yatxatapxañäni

2. Akiri qillqata ullapxañäni.

¿Kunasa p'itawinakasampi kamachpachaxa?

Marsila  awichaxa Samira allchhiparuwa alwatha sartayäna, juparu mä suma  ch'ullu p'itaña yatichäna.

–  Ch'ullu pit'añxa taykajawa wawakayätha ukapachana yatichawitu– sänawa.

Taykanakampi awichanakasampixa imilla wawanakaparu, allchhinakaparuwa kunjamsa

 ch'ulluxa thayatha jark'aqasiñataki p'itaña, uka amtayäna. Jichhürunakanxa taykanakasa janikiwa p'itaña yatichxapxiti, ukathwa ch'ulluxa inasa jani uchasxapxchiti,

yaqhipa  jaqinakaxa alxañatakikiwa lurxapxi.



Yatiqiri masimampi jani ukjaxa wilamasimampisa aruskipma, kunathsa uka p'itañanakaxa jaytanukutäxi, uka tuqitha.

3. Arst'asisa ukhama qillqatampi jiskht'anakaru jaysma:

- ¿Kunsa awichaxa allchhiparu yatichäna? ¿Kunsa yatiyäna?
- ¿Kunathsa wawanakaru janiki awichanakaxa yatichxapxpacha?
- ¿Kamachasphasa p'itaña jani yatichasxaspha ukjaxa?
- Qillqatarjama, ¿Kuna kamachatathsa p'itañanakaxa jani yatichasxixa? Kutt'ayatama qillqama.

4. Kutt'ayawimarjama sixst'ma.

- ¿Khitinakasa jichhürunakana p'itasipki?

- ¿Kunatakisa jichhürunakana p'itatanaka lurapxi?

5. Jamuqataru chiqapa amuyumpi tupayma.

wiskha

chala

ch'ullu



6. ¿Kunathsa jiwasa p'itata isinakampi janiki uchasxapxthana?, uka yatxatañataki, wilamasimampi aruskipma.

7. Kunfi wilamasimaxa yatiyktama, ukxata sixst'ma ukhama qillqt'ma.

Handwriting practice area with three horizontal dashed lines on the left and a yellow rounded rectangle on the right containing a pencil icon.

8. Yatiqiri masinakamaru sixst'atamatha ukhamaraki qillqatamatha yatiyma.

Yatiqatasatha amuykipapxañäni

9. Jiskht'anaka ullt'ma, ukhamaraki kutt'ayawima samichma.
¿Aski wakisiripachati p'itaña yatichañaxa?

Jisa



Janiwa



• ¿Kunathsa?

Handwriting practice area with a horizontal dashed line.



2 Laphi

P'itañanakxata ullapxañäni ukhamaraki qillqapxañäni

Yatiqañataki wakichasipxañäni

1. Yatiqiri masinakamampi aruskipma.

¿Marsila awicha p'itañatakixa kunasa wakisi lurañaxa?



Ch'ullu ukhamarusa chala p'itañataki wakichasipxañäni.

Askipacha yatxatapxañäni

2. Ch'ulluxa kunjamasa p'itaña uka tuqitha ullapxañäni.



P'itaña yänaka

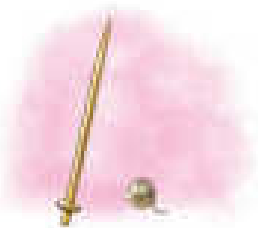

Qapuña

1. Mä jawita t'awra apaqaña.
2. T'awrawa t'isaraña.
3. Allphachu t'awra qapuña.
4. Qaputa ch'ankha khiwiña.
5. Khiwita ch'ankhawa layiña.
6. Ch'ullu p'itañawa qalltaña.

1



4



2



5



3



6



3. Jiskht'anakaru arst'asa jaysma.

- ¿Kunsa qillqataxa yatiyistu? ¿Kunatakisa qillqataxa luraspacha?
- ¿Kunatakisa aka qillqataxa wakisiripacha?

4. Qillqatana uñt'ata arunaka muyuntayma.

AWICHA

t'awra

p'itaña

p'itiri

ch'ankha

layiña

anilina

ch'ullu

qapu



Awichaxa allchhiparu
allphachu t'awrata ch'ullu
p'itaña yatichäna.

5. Jichhaxa akiri arunaka thaqma awicha - ch'ullu sutipa samiparjama samichma.



awicha



ch'ullu

awicha

chulla

ch'ullu

allchhi

chullu

awicha



Samira wawaxa arunaka jaljayaña muni, apnaqalla qillqanakampi ukataxixa yanapma.

6. Jamuqanaka uñxatt'asa sutinakapa ullt'ma. Arunakana sapa sallaparjama muyunakaru samichma, ukathxa kajunallanakaru aru jaljayata qillqma ukhamasa samichma, ukathxa kajunallanakaru aru jaljayata qillqma.



awicha



ch'ullu



7. Uka Arunaka ulläsina sapa sallanaka jaljayma.



ch'ullu

--	--	--	--	--	--	--



awicha

--	--	--	--	--	--	--

8. Sapa aruna jaljayapa maya riximpi tupayma ukatha kikiya samimpi samichma.



ch'ullu

ch'u

llu



awicha

a

wi

cha

¡Yatiqata arunakampi mä qillqata wakichapxañäni!



9. Jichhaxa, awicha – ch'ullu uka aru jakitanakampi amuyuru phuqachma.

Marsila  _____ xa allchhiparuwa allpachu t'awra

qapuña yatichi  _____ p'itañataki.

Samiraxa wali k'uchiwa  _____ qapuri uñjäsina

 _____ p'itañataki qapuña tatiqaski.

Yatiqatasatha amuykipapxañäni

10. Arst'asa jaysapxañäni.

- ¿Jumataki uka lurawinxä kunasa khusänxa? ¿Kunathsa?
- Kasta t'awranakatha p'itañataki wilamasimampi aruskipma.



3 Laphi

P'itañanakxata yatiñanaka ull't'apxañäni ukhamaraki qillqt'apxañäni

Yatiqañataki wakichasipxañäni

Yatiyayawi ullapxañäni kunathsa janiki p'itxapxthana uka tuqitha yatxatapxañäni.



Askipacha yatxatapxañäni

1. Janira qillqata ullkasa, jaysma:

¿Qillqatanxa kunanaksa qhananchi?

¿Kuna yatiwinaksa yatxatapxpachañäni?

2. Yatiyawi ull't'apxañäni ukatha amuyumampi chikayma.

Yatiyawi

Kunathsa  ch'ulluxa jani apnaqatäxi ukxata aruskipt'añatakiwa markasana urupa amtaskipana taqiniru suyt'apxamama.

Tantachasiñawja: Marsila  awichana utapana.

Uru: Lunisa, tunkapayani uru, julyu phaxsina

Pacha: Kimsaqallqu alwa urasa.

 ch'ullunaka apanipxäta.

Ayllu p'iqinchiri.

3. Yatiyawı ullawsına jaysma:

- ¿Kunsa uka qillqataxa yatiyistu?
- ¿Kuna tuqithsa mathapiwına aruskipapxani? ¿Kunatakisa?

Jichhaxa uka aru
apnaqañanakampi arunaka
qillqapxañäni.



4. Aru jaljatanaka ullma, ukatha askichäsına qillqma.



llu

ch'u



wi

cha

a

5. Tarjitanaka ulläsına sutinakapa taypına aru jaljanaka uñ'tatama maya muyumpi muyuntayma.



llachu

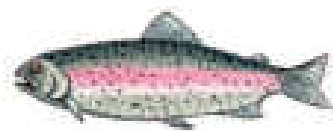

chawlla



awicha



ch'ullu

6. Ch'ullu  awicha  uka arunakampi yaqha aru jaljanaka uñstayapxañäni.

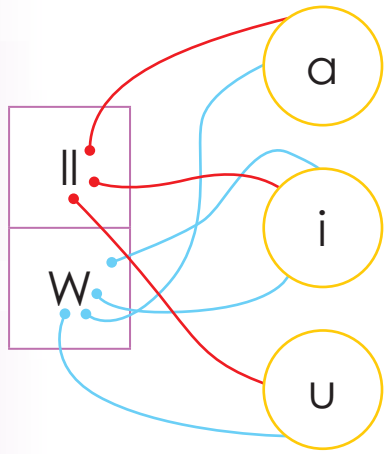

lla			all		
	wi			iw	

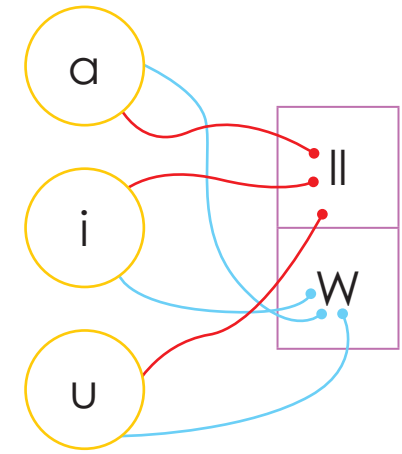

7. Machaqa sutinaka uñstayañataki uñjatama aru jaljanakampi phuqacht'añäni.



chu _____

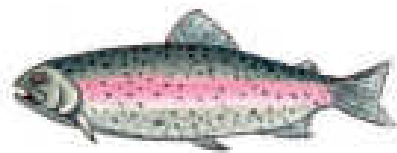

chaw _____



_____ ka



a _____ cha



wis _____



_____ chi



a _____ yu



_____ ka

8. Uñjkthana uka aru jaljanakampi yaqha arunaka qillqantma ukathxa jamuqt'arakma.

9. Uñjkthana uka arunakampi aka qillqata phuqacht'arakma.

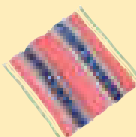

_____ allchhinakaparu ch'ullu awayu  sawuña yatichi.

_____ nakaxa jawiraru  _____ naka katuri sarapxi.

Yatiqatasatha amuykipapxañäni

10. Jaysma:

- ¿Kuna arunaksa yatiqawthana? ¿Kunjamsa lurawaythanxa?
- Nayra p'itatanaka p'itañatakixa kuna t'arwanakasa apnaqata uka sutinaka qillqañataki wilamasinakamampi aruskipt'ma.



4 Laphi

Yatikipayasipxañäni

Yatiquañataki wakichasipxañäni

1. Jiskht'anakaru jamuqa uñxat'asa jaysma.

- ¿Mamaxa kunsä luraskixa?
- ¿Ch'iqä ampärampi qaputaxa kunatakisa askipacha?
- ¿Jumaxa uñjiritati ch'iqä ampärampi qapurxa?



Askipacha yatxatapxañäni

2. Wilamasimampi, yatiqiri masimampisa, kunatakisa askipacha ch'iqä tuqi qaputaxa, uka tuqitha aruskipapxma. Sixst'ma ukhamasa qillqt'ma.



3. Kunfi awichaxa siskana uka tuqitha ull't ma.



Wawanakana awkipatha
taykapatha jani
llakisipxañapatakiwa ch'iqa
qaputa ch'ankhampi ch'iqa
ampararu chint'aña.



4. Qapuñataki iwxañaka arkapxañäni ukathxa sixst'apxañäni ukhamaraki qillqapxañäni.

5. Janira qillqkasa sixst'kasa jiskht'anaru jaysapxañäni:

¿Kunatakisa iwxañaka
qillqthana?

¿Kuna iwxañakasa aski
wakisiri?

¿Yäqapxañasati uka
iwxañakxa?

Qapuñataki wakisiri iwxañaka tuqitha sixst'ma ukhamasa qillqt'arakma.

6. Yatiqiri masinakamampi mathapisina iwxañaka qillqapkatayta uka tuqitha yatxatapxañäni.

Luratama
uñanchayma.



Jani armt'asimti, jach'atha
qhana arumpi arst'aña.

7. Yatiqiri masinakamana iwxañakapa aski ist'ma.

8. Ullawsina aski ist'awsinsa lurawinakamarjama samichma.

Jach'atha qhana
arumpiwa iwxañaka
ullt'awaythxa.

Yatiqiri masinakajana
iwxañakapa askwa
ist'awaythxa.

Jiskht'awaythwa.

Yatiqatasatha amuykipapxañäni

9. Arst'asa jaysapxañäni.

- ¿Iwxawinakaxa wakisiriti? ¿Kunathsa?
- ¿Iwxañaka qillqañaxa nayraru sartaña yanaptamti? ¿Kunathsa?

Lurataja uñt'ayaja

5 Laphi



Yatiqañataki wakichasipxañäni

1. Mayninakampi aruskipma.

¿Kunathsa juk'aki apnaqatäxi jiwasa p'itata isinakaxa, uka tuqitha yatiyasmati?



¡Maya warurt'a qillqapxañäni!

Askipacha yatxatapxañäni

2. Janira qillqasa jamuqanaka uñxatt'ama warurt'ama qillqañataki.

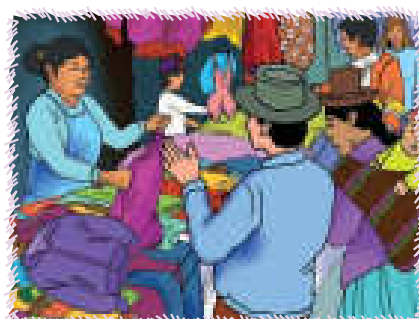

3. Qillqt'añataki wakichasipxañäni:

¿Kunsa qillqañanixa?

¿Kuna tuqithäpachänisa?

¿Khititakisa qillqañänixa?

4. Warurt'ama qillqst'ma ukhamasa sixst'arakma. ¡Janiwa jach'añapäkiti!

Handwriting practice area with a set of blue dashed lines on the left and a yellow rounded rectangle on the right containing a drawing of a pencil.

5. Yatiqiri masinakamataki warurt'ma, jupanakaxa ukxatxa kunsä amuyapxi, uka ist'ma.

Yatiqatasatha amuykipapxañäni

6. Arsuwimpi kutt'ayma:

- ¿Warurt'ama yatiyañaxa khusänti? ¿Kunathsa?

Wilamasimampi ukhamarusa yatiqiri masimampi qillqatamatha yatiyma.



Qhichwanakana p'itatapatha yatxatapxañäni

6 Laphi



Yatiqañataki wakichasipxañäni

1. Janira qillqata ullt'kasa, jaysma.
2. ¿Kunathsa qillqataxa yatiypachistani? ¿Kunjamsa qhichwanakaxa p'itapxpacha?

Askipacha yatxatapxañäni

3. Qillqata ullapxañäni.

Qhichwanakana p'itawipa ukhamaraki sawuwipa

Qhichwa ayllunakanxa allphachu, uwija ch'ankhanakampiwa chalanaka, ch'ullunaka p'itasipxi.

Warminakampi wawanakampiwa qapupxi ukhamaraki samichapxi.

Manta, chusi, punchu, ukhamasa awayu sawuñatakixa ch'ankhaxa kunaymana saminiñapawa.

Sawuñataki tiljatäki ukawjanxa janiwa mäkipañati, jani ukaxa t'aqisnawa sawuña tukuyañatakixa.

Wawanakaxa jilirinakarü uñch'ukisinwa yatiqapxixa.

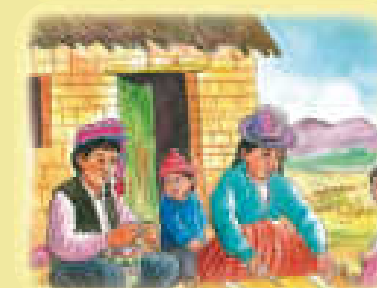
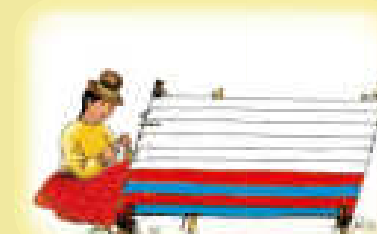

4. Akiri jiskht' anakxata yatiqiri masinakamampi aruskipt'ma:

- ¿Qhichwanakaxa kuna t'awrathsa p'itapxi? ¿khitinakasa qapupxi?

5. Qhichwa ayllunakanxa kunjamsa p'itapxpacha uka tuqitha amuyäsina sixst'ma.



Yatiqatasatha amuykipapxañäni

6. Arsuwimpi kutt'ayma.

- ¿Qhichwanakxata yatiñaxa askiti? ¿Kunathsa?
- ¿Allphachu t'awranakatha ayllumanxa p'itasipkiti? ¿Kunsa p'itapxi?

P'itata isinaka uchasipxañäni

8ri

Yatiqawi



Aski wakisiri utjirinaka:

Taqi markanakana ukhamarusa ayllunakansa jaqinakanxa suma lurtawinakapaxa utjapuniwa, jisnawa; p'itawinakasa, sawutanakasa, samichatanakasa, khitutanakasa, kunaymananakampi.

Nayra pachaxa jupanakpachakiwa lurasipxiřina, isisiñatakisa mayniru alxañatakisa. Jichhaxa mä qhawqha luririxa alxañatakikiwa lurxapxi. Ukhamiphaxa jichha jaqinakasa naylu isikwa uchasxapxaraki. Yamasa wawanakaxa p'itañanakxa janikiwa yatxapxiti.

Uñxatma ukatha kut'ayma:

1. ¿Jamuqana markachirinakaxa kuna lurawinkapxisa?
2. ¿Ukhama lurawina yanapirritati? Aruskipma.

Ch'amt'añasa:



¿Kamachsnasa p'itatanaka ukhamasa sawutanaksa kunanakathsa jani uchasxthana uka yatxatañataki?

Lursuta. Sawutanakasxata p'itatanakasampitha mä qillqa qillqasma.



1 Laphi

P'itawisa tuqitha yatxatapxañäni

Yatiqañasataki wakichasipxañäni

1. Wilamasimampi ukhamarusa yatiqiri masinakamampi aruskipma.

¿Jiwasa p'itatanaka jani khitisa uchasxaspha ukjaxa kamachasphasa?



Askipacha yatxatapxañäni

2. Akiri qillqata ullma.

Jiwasana yatita p'itawinakasa!



Awichaxa imilla wawanakaru yatita p'itañanaka yatichañatakixa wali ch'ikinawa. Jupaxa p'itañsa ch'ukuñsa yaticharakinawa, akhamanaka: ch'ullu, chumpa, chala, allmilla, phantillu, phullu aski istapisiñataki, ukhamaraki sawuñanaksa; wak'a, istalla, ch'uspa, unkuña ukhama.

Jichhaxa jaqinakaxa uka p'itañanaksa naylutaki lurxapxi, ukhamasa yaqha tuqi uñtanakani, niyasa chanipaxa iraqatakiwa. Ukanakathpi jaqinakaxa jiwasana p'itatanakasa jani uchasxapxitixa.



Awichaxa llakitawa, kunathfi wawanakaxa jani thaya jark'iri naylu isikwa uchasxapxi, taqi ukanakathwa thayampi usuntapxaraki, ukhamayphanxa taqinisa janikiwa k'umaräxthanti.

Jiwasana p'itata, jiwasana sawuta isinaxata aruskipapxañani.



3. Arst'asa jiskt'anakaru Jaysma.

- ¿Kunathsa jiwasana p'itata isinakasa luraña armanukxapxi?
- ¿Kunarusa puririsna naylutha lurata isinaka alatampiki isixapsna ukjaxa?

4. Amuyu ull'tma, ukatha kawkiri jamuqampisa wakt'i ukampi tupayma.



Jaqinakaxa jiwasana p'itata isinakasa janikiwa uchasxapxiti, naylu isikwa uchasipxi ukatha thayata usuntapxi.



Warminakaxa p'itañanakapsa naylu ch'ankampikiwa p'itxapxaraki.

5. Jaysma. ¿Jiwasana p'itatanakasa isinaka chhaqtxaspha ukjaxa kamachasphasa? ¿Kunathsa?

6. Wilamasimampi jani ukachaxa yatiqiri masimampisa jiwasa p'itata isinaxata aruskipma.
7. Jiwasa p'itata isinaxa janikiti uchasapsna ukjasa kunasa kamachaspha, uka tuqitha wilamasimaru jiskht'ma, ukhamasa wasitatha yäqañatakixa kunasa lurañaspha uka sixsma, ukhatha qillqasma.

Kunanakampisa	Waqiyayña

8. Yatiqiri masinakamaru jani ukjasa wilamasimarusqa qillqasutama, sixsutama yatikipayma.

Yatiqatasatha amuykipapxañäni

9. Jiskht'awinaka ulläsina kutt'ayawima (X) chimpuntma.

- ¿Jiwasa p'itatanakasa janikiti uchasapsna ukjasa kamachasphasqa, uka uñt'añaxa wakisisphati?

Jisa

Janiwa

- ¿Kunathsa?

- ¿Kuna qhanañchawisa arxatañaspha?

Jiwasana p'itañanakasatha ullapxañäni qillqsupxarakiñäni

2 Laphi



Yatiqañataki wakichasipxañäni

1. Wilamasimampi jani ukjaxa yatiqiri masimampi aruskipma.

- ¿Jiwasana p'itata isinakasa janiki uchasxapsnasti kamachasphasa? Kunfi sapktama uka sixsma ukatha qillqasma.

Askipacha yatxatapxañäni

2. Yatiya ullma ukata jaysma.

Yatiya

Taqi ayllunkirinakansa t'awrampi jiwasana p'itatasaxa janikiwa walinkiti, chhaqtirpachawa. P'itirinakasa naylumpikiwa p'itxapxi ukhamarusa jaqinakaxa jiwsana p'itata isinaksa janiwa uchasxapxarakiti, Ukhamayphana janikiwa k'umara jakasxapsnati, ukanaka qhanst'ayañatakiwa mathapisipxañäni, uka yatiyanipsma:

Kawkinkanisa : Awichana utapana.

Pacha : 4: 00 jayp'urjaru.

Uru : anata phaxsina, 26 tuminku urunkaniwa.

Apaniña :    , yaqhanakampi.

3. Wilamasijampi jani ukjaxa yatiqiri masijampi yatiya ullawasinx a aruskiptha.

- ¿Qillqataxa kuna tuqithasa? ¿Khitiru uñtayatasas? ¿Kuna tuqithsa aruskipañäni?
- ¿Yatiyaxa kuna qhanañchanakanisa?



Warminakaxa
kunanaksa mathapiwiru
apañanakapaxa uka
amtayañaru yanapt'ma.

4. Akiri 363 laphinkiri llip'katayañanakampi wakisiriwjaru llip'katayma.



wak'a

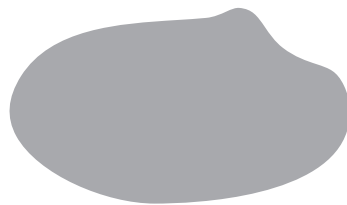

q'urawa



wiskha

5. Uñtaparjama sutinaka samichma.

wak'a	wank'u	waka	wak'a	k'awna
q'urawa	q'uwa	q'usu	q'urawa	q'uma
phullu	phuyu	phullu	phuju	phuku

Maya wawaxa jani ukankiri
sallanaka phuwqañchañapaxa
¡Yanapt'ma!



6. Wakiskiri aru jaljanakampi arunaka phuwqañchma.

wa q'u k'a ra phu llu



wak'a

wa



q'urawa

ra



phullu

llu

7. Sixsutanakana sutipa wakisiri sallanakampi phuwqachma.



wis _____ cha



ch'u _____



_____ llu



wa _____ wa _____



siwa _____



a _____ cha

8. Arunaka ullma ukatha uñt'ata sallanaku muuntayma.

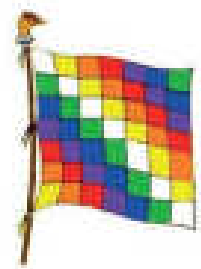

wi pha la



wis kha



a wi cha



cha la

9. Qillqataru kuna arunakati wakiski ukampi phuqachma.



_____ xa warminaku mä mathapiwuru jawsthapiyatayna



_____, _____ sawuñataki.

Yatiqatasatha amuykipapxañäni

10. Arsumpi kutt'ayma.

- ¿Wilamasimanxa kuna uñt'ata p'itañanaksa p'itapxisti? Wilamasimana yanapt'ayasisna sutinakapa qillqasma.

Wiskha k'anañataki iwxañaka ullañäni ukhama qillqsupxañäni

3 Laphi



Yatiqañataki wakichasipxañäni



Awichanakawa
wiska k'anaña tuqi
aski yatiñanipxi,
wawanakaruxa
jupanakawa
yatichañaparaki.

Askipacha yatxatapxañäni

1. Qillqata amusaki ullt'ma, ukathxa uñt'atama arunaka muyuntayma.

Qurawa k'anaña yatichañataki iwxañakapa

Juliku achachilaxa iwxañakapwa qurawa k'anaña jani chhaqtañapataki arkañasaxa, akirinakawa:

Juliku achachilaxa qurawa k'anaña yatichaski akirinakarjama arkasa.

- Allphachu t'awra yawiraña.
- Yawiratha tawra t'saraña.
- T'isaratha t'awra mismiña.
- Mismitanaka payata phalaña.
- Phalatanakampi q'urawa k'anaña.



2. Sapa jamuqana sutipa qillqma ukhama arunaka sallanakaru jaljtayma ukxaru aru t'aqanakaru.

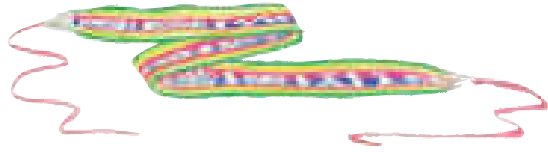

wa _____

w	a	K'	a
---	---	----	---

wa	K'a
----	-----



_____ ra _____

--	--	--	--	--	--

--	--	--

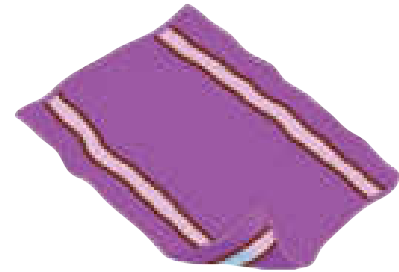

phu _____

--	--	--	--	--

--	--

3. Amuyunaka wakisiri arunakampi phuqachma.

- Urpi  _____ xa  _____ uchasiski.
- Santikumpi awkipampi  _____ k'anasipki.
- Irma  _____ xa  _____ sawuski.

4. Wak'a, q'urawa, phullu uka qillqanakampi machaqa aru t'aqanaka uñstayañaru anatiñäni, yaqha arunaka jakiñataki.

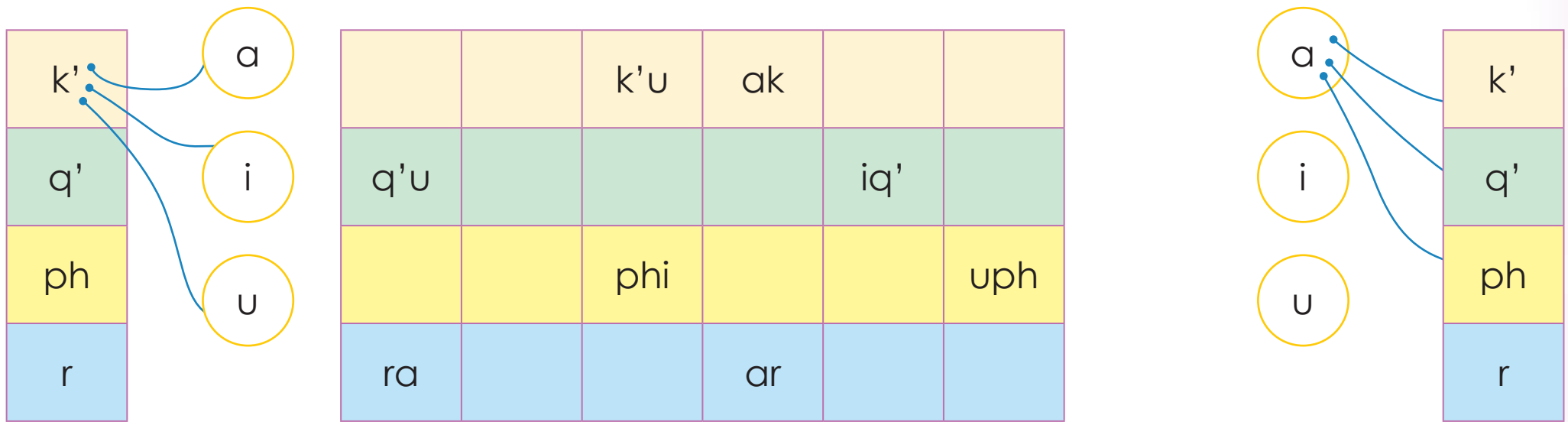

¡Maya wawaxa machaqa aru t'aqanaka jakitayna wali khusawa!

5. Aru t'aqanaka jakitamampi arunakaru phuqachma ukata sutinaka uñstayma.



way_____



_____wa



_____lla_____



_____si



ru_____



_____ku

6. Qillqatanaka phuqachama.

Aski mathapiwinakataki

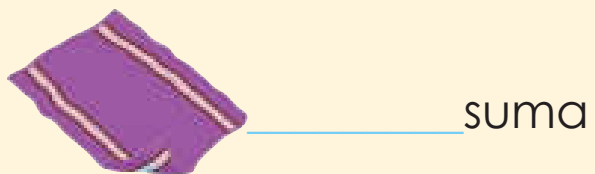

saltani



_____ uchasipxthna,



_____.

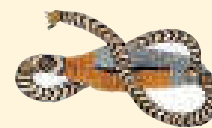

_____ mpi

thuqtañaru anatasipki.

Yatiqatasatha amuykipapxañäni

7. Kutt'ayma.

¿Kunjamsa machaqa arunaka ullaña ukhama qillqaña yatiqthansti?

Aruskipapxañäni

4 Laphi



Yatıqañataki wakichasipxañäni

1. Jamuqa uñxatma ukhama jiskht'anakaru kutt'ayma.

- ¿Kunsa kamachasipki sawutampixa?
- ¿Kunathsa sawutanakaxa jani khuchjañakpacha?
- ¿Jaqinakaxa uka yatıyxa yäqapxpachati? Aruskipma.



Askipacha yatxatapxañäni

2. Wila masimampi sawuña yatıyanakatha aruskipma. Kuntıxa sapktama uka sixsma ukatha qillqisma.

3. Yatiri kunti jiskchitu uka ullt'ma.



Janiwa sawutaxa
khuchuñati, ajayuniwa.



4. Wak'a lurawixa kunathsa jani chhaqtañapa, uka tuqitha kunjamasa uka uñt'ayañäni ukhamarusa kamachañänisa yäqkakiñataki mä yatiya amuyapxañäni.

5. Yatiya janira qillqkasa, yatiqiri masinakamampi akirinaka tuqitha aruskipma.

¿Kamachasphasa
p'itañanaka alxañatakiki
lursna ukjasti?

¿Kunjamsa uñt'ata wak'a
luraña yatiqsnasti?

¿Khitisa yatichasispha
ukhamsa kawkinsa?

6. Jichhaxa yatiyama qillqasma.

Handwriting practice area with seven horizontal dashed lines for writing.

7. Yatiqiri masinakamampi yatiya qillqutanaka uñt'ayañataki mathapisma.

¿Kamachasphasa
p'itañanaka alxañatakiki
lursna ukjasti?

¿Kunjamsa uñt'ata wak'a
luraña yatiqsnasti?

Yatiya mä laphiru qillqasma
ukatha yatiqaña utarusa
jani ukachaxa ayllumana
utaparusa llip'katayma.



Yatiyama llip'katayäsina
amuyuma wakichaña
janiwa armasitati aski
yatiyañataki.

8. Yatiqiri masinakamana yatxatayawinakapa aski isch'ukma.

9. Yatiyama yatxatayawasinxä, lurawinakama samichma.

Mitsuwinaksa
yatiythwa

Jach'ata ukhamarusa
qhana arsuwthxa

Yatiqiri masinakajana
yatxatayawinakapa
askiwa isch'uthxa

Yatiqatasatha amuykipapxañäni

10. Arsuwimpi kutt'ayma.

- ¿Yatiya yatxatayañaxa askiti? ¿Kunathsa? ¿Uka yatiya kuna yaqha lurawinakansa apnaqasmäxa?



5 Laphi

Lurataja uñt'ayaja

Yatiqañataki wakichasipxañäni

¿Wilamasimaru ukhamasa yatiqiri masinakamarusa p'itata isinaka jani uchasksna ukaxa kamachasphasa uka yatxatayaña munasmati?



¡Maya jarawi qillqasuñani!

Askipacha yatxatapxañäni

1. Janira qillqkasa, jamuqanaka uñxatma ukatha jarawi qillqasuña yanapt'ayasiñataki sapaqata lurawi qhanañchma.



2. Qillqa wakichkipma:

¿Kunsa qillqañäni?

¿Kuna tuqithsa qillqañäni?

¿Khititakisa qillqañäni?

3. Kamachasphasa jiwasana isinakasa jani p'itxapxaspha ukjaxa, uka yatxatayasa mä jarawi qillqasma, ukathxa kunasa yäqañataki wakisispha lurañaxa, ukampi.

Handwriting practice area with six horizontal dashed lines on a white background.

4. Wilamasimataki ukhamasa yatiqiri masimanakataki jarawt'ma, ukatha khuspachañapataki iwxanaksa ist'ma. Kuna samini laphirusa jarawima qillqasma, ukatha taqini ullt'añapataki yatiquña utarusa, utamarusa, jani ukjaxa ayllumarusa llip'katayma.

Yatiquatasatha amuykipapxañäni

5. Arsuwimpi kutt'ayma: ¿Kunsa aka lurawina k'atampi munawtasti? ¿Kunathsa?

Jarawima kawki chiqansa taqini ullt'apxaspha, ukawjaru llip'katayma.





6 Laphi

Shawi aylluna p'itawipatha uñt'apxañäni

Yatiqañataki wakichasipxañäni

1. Janira qillqata ullkasa, kutt'ayma.

- ¿Qillqataxa kuna tuqithsa arspacha? ¿Kunjamäpachasa Shawi aylluna p'itawipaxa?

Askipacha yatxatapxañäni

2. Qillqata ullt'ma.

Shawi aylluna p'itawipa

Shawi ayllunxa chacha warmi ukhamawa p'itapxi. Warminakaxa qira t'awrathwa p'itapxisa sawupxisa. Ukatakixa t'axsupxi, wañsuyapxi, qapupxi, ukathxa kunaymana q'ipiñanaka, muchilanaka yaqhanakampsa p'itapxarakixa.

Chachanakaxa jikra, kanastanaka yaqhanakampsa lurapxi, ukhamasa tamshi yaqha yänakampi apnaqapxaraki. Tamshi apsuñatakisa walja alwarakiwa sarapxixa, ukana taykaparusa aski thuriñapataki luqtapxarakiwa.

P'itañatakixa qira ch'anaka k'antapxixa, mayachañataki ukhama p'itaña qalltañataki.



3. Yatiqiri masinakamampi aruskipma, jiskht'awinakarjama.

- ¿Shawi jupanakaxa p'itañanakapa kuna ch'ankampisa lurapxi? ¿P'itañataki uka ch'anaka kamachapxisa?

4. Shawi aylluna p'itatanakapa ukhamasa kunjamsa lurapxi uka sixsma.

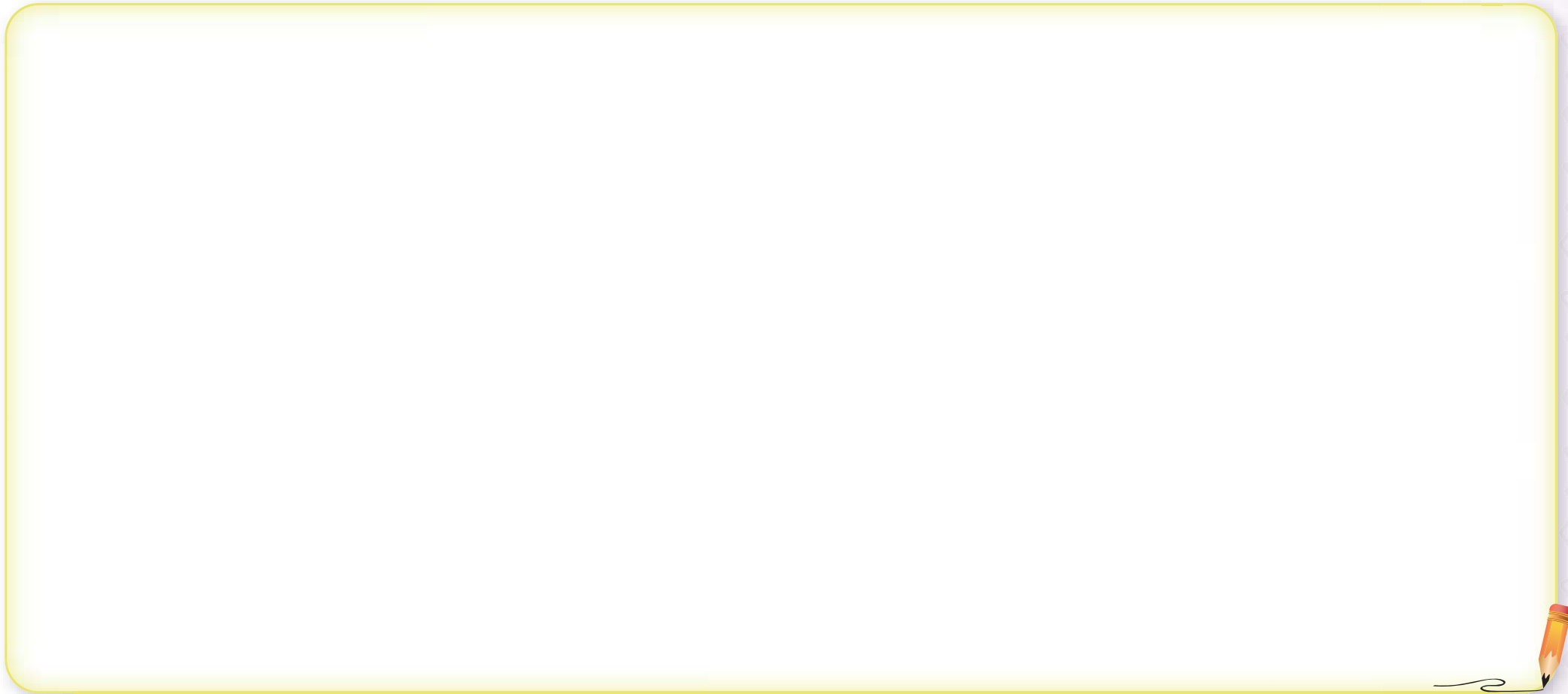

Yatiqatasatha amuykipapxañäni

5. Arsuwimpi kutt'ayma.

- ¿Shawi aylluna lurawipa tuqi yatiqatamaxa munañjamati? ¿Kunathsa?
- ¿Ayllumana p'itañataki kuna yatiwinakasa utjisti?



¡Anatapxañäni!

- Amuyunaka ist'ma ukatha aru arsutanaka chimpuntma.

Awichajaxa allchipataki ch'ullu p'itarapitayna.



Amaru wawaxa masinakapampi atipa atipa q'urawa k'anaski.

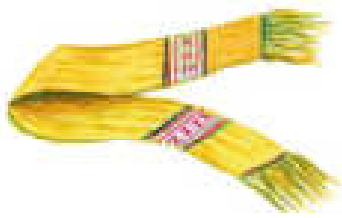

- Qapu sixsusina kimsa amuyu qillqt'ma.

Handwriting practice area with three sets of dashed lines on a light purple background.

5^{ri}
T'aqa

Utachañanakasa



¿Kunjamäskisa ayni mink'a ukanakaxa uta utachañanxa?

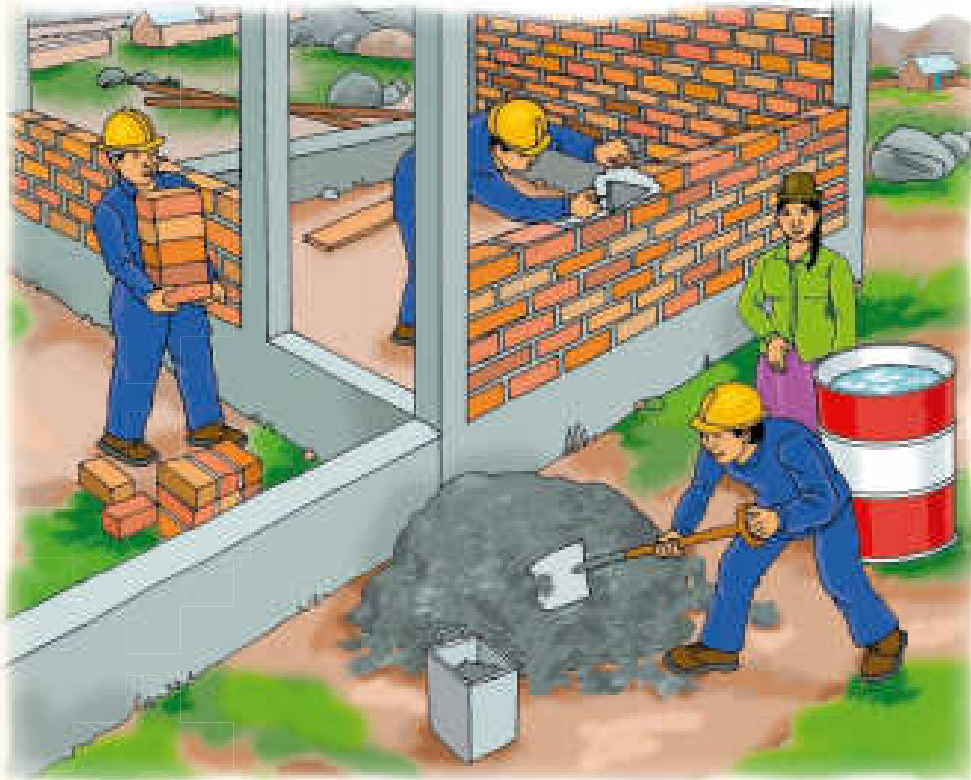

Aski wakisiri utjirinaka:

Jichha pachanakaxa ayllunakana jaqichasirinakaxa utjasipxañapataki utanakwa utachasipxi, kunaymana uñtaninaka maymaya yänakampiwa utachapxixa. Yaqhipa ayllunakanxa taqiniwa aynikiwa sasa aliqaki yanapt'asipxixa, yaqhipanakanxa mink'ampiwa lurapxaraki. Yamasta jichhanakaxa mink'anakasa qullqithakwa luriri sarxapxi, aynisiñaxa chhaqtirjamakixiwa.

Uñakipma ukhamasa jaysma.

1. ¿Kuna lurañanaksa jamuqatanxa jaqinakaxa lurapxi?
2. ¿Jumaxa aka lurawinxaxa irnaqawtati? Yatiyma.



Ch'amt'añasa.

¿Kunjamathsa utachawinakana aynisiñatha, mink'asiñatha yatxatapxirisna?

Lursuña: Kunajamäskisa aynisiña, mink'asiña utachawinakana uka yatiyma.

Utachkasaxa kunathsa juk'aki aynisitäxi mink'asitaxi ukxata yatxatapxañäni

1 Laphi



Yatiqañataki wakichasipxañäni

1. Wilamasinakamampi ukhamaraki yatiqiri masinakamampi aruskipma.



¿Jichhürunakaxa, kunjamsa utachañanakaxa ukxa amuyasipkiti.?

Askipacha yatxatapxañäni

2. Akiri qillqata ullapxañäni.

Utachañanxa mink'a, ayni ukanakaxa janiwa ancha uñjatäxiti

Tata Santikuxa allchhinakapampiwa alwatha utapa utachañataki yänaka aptiri saratayna. **Lawa, qala** ukhamaraki **jichhu** ukanakawa utachsuñataki wakisina.

Jak'apana utjasirinakaxa janiwa yanapt'asirjamapkänti. Santiku tataxa - ¿Kamachañänisa jichhaxa? Yanapawa munasi - sasawa säna.

¡Jichha urunakaxa janikirakisa aliqa yanapt'asxaphanti! Nayrapachaxa taqinisa yanapt'asipxiriinwa.

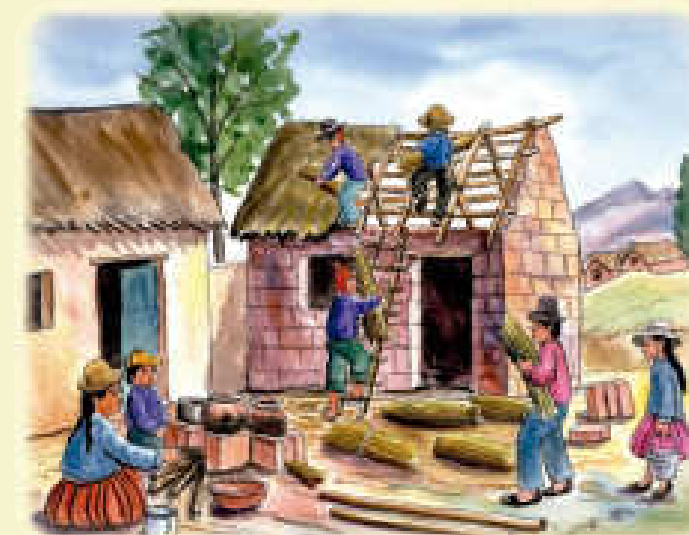



Masinakamampi
jani ukjaxa
wilamasinakamampi ayni
mink'a uka tuqinakatha
aruskipma.

3. Yatichirimampi aruskipma ukhama jiskht'anakaru kutiyma.

- ¿Kunathsa qillqatana piqinchapaxa sispacha: **Utachañanxa mink'a, ayni, ukanakaxa janiwa ancha uñxatäxiti**, sasaxa?
- ¿Kuna yänaksa tata Santikuxa utapa utachasiñataki munixa?
- ¿Kunsa aynitha mink'atha yattaxa?

4. Amuyanaka ullt'ma ukatha jamuqatampi tupayma.



Jaqinakaxa uta pirqasipki.



Jaqinakaxa mä uta utachsusipxi.



Utachaña yänaka.

5. Wilamasimampi uta utachawinakana kunathsa janiki aynisxapxi, mink'asxapxisa uka tuqitha aruskipäsina yatxatma.

6. Kunathsa janiki aynisiña mink'asiñasa munxapxi, uka tuqitha sixsma ukhamarusa qillqt'arakma.

7. Masinakamaru jani ukachaxa wilamasinakamaru qillqatama sixsutama yatikipayma.

8. Qillqatana uñañchata arunaka samichma.



jichhu



phala



uta



wiri

Yatiqatasatha amuykipapxañäni

9. Jiskht'anaka ullt'ma, yatiyama chimpuntma ukhamasa jaysma.

• ¿Wakisiriti irnaqañanakana yanapt'asiwinakatha yatxataña?

Jisa

Janiwa

• ¿Kunathsa?



2 Laphi

Uta utachañataki munasiri yänakatha ulläsina qillqapxañäni

Yatiqañataki wakichasipxañäni

¿Kuna yänakasa munasi utachañataki?



¡Utachaña yänakatha ullt'apxañäni!

Askipacha yatxatapxañäni

1. Ullt'apxañäni.

Utachaña yänaka

Utachxatañataki	Pirqañataki	Isthapiyañataki
 kalamina	 aruwi	 punku
 jichhu	 ñiq'i ñiq'i	 t'uxu

2. Ullawsina jaysma.

- ¿Kunsa uñt'ayasi uka yatiyaxa? ¿kunjama wakiyatasa?
- ¿Kunatakisa utachaña yänakxata ulläsina yatxatapthanxa? ¿Khitinakatakisa uka qillqataxa?

3. Sixsutanaka samichma ukatha sutipampi tupayma.

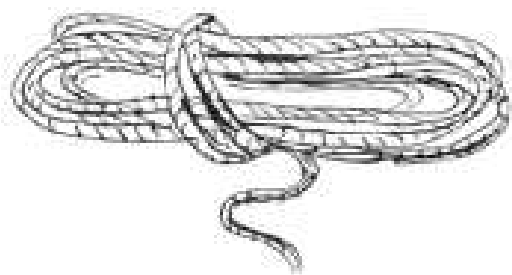

jichhu

phala

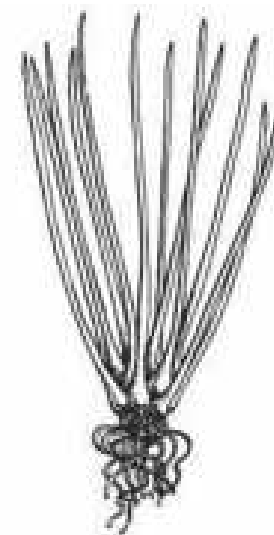

4. Kikipa arunaka mä samimpiki samichma.

jichhu	chhuru	JICHHU	chhiwchhi	jinchu
phala	phasa	phala	phaxsi	PHALA

5. Sapa jamuqanakana sutipa mä muyumpi muyuntayma.



jichhu	aruwi	lawa
qala	JICHHU	
phala	ch'ampha	ch'illiwa
wiskha	PHALA	

6. Uñt'atha arunakampi amuyuru phuqachma.

Tata Santikuxa



_____ utachaña amtatayna, ukatakixa



naka,



_____ ukhamasa



_____ ukhama

wakisirinaka jach'a qhatutha alasinitayna



Samiraxa yänakana
sutinakapa
jaljayañaruwa anati.

7. Jichhaxa yatiyani wakichata ulläsina, sapa jaljayapa jaljayma, ukatha lapisamampi samichma.

jichhu

ji

chhu

JI

CHHU

phala

pha

la

PHA

LA

Jisk'a wakiyata
qillqanaka
apanuqma.



8. Arunaka ullma ukatha uñt'ata sallanakaru muyuntayma.



ch'i lli wa



ji chhu



la wa



a ru wi



u ta



pha la

9. Sapa aruna jaljayapa maya riximpi tupayma, ukhama kikipa samimpi samichma.

jichhu

ji

chhu

la

pha

phala

Yatiqatasatha amuykipapxañäni

10. ¿Kuna arunaksa ullt'aña yatiqawthanxa? ¿Kunjamathsa?



3 Laphi

Utachaña yänakxata ullapxañäni qillqapxañäni

Yatiqañataki wakichasipxañäni



¿Kunjamasa ñiq'ixa?
¿kunjamasa ñiq'ixa
wakichaña?

Askipacha yatxatapxañäni

1. Janira yatiya ullkasa, jaysma:

¿Kunatakisa yatiya qillqata ulltanxa?

¿Kuna yatiysa yatxatañänixa?

2. Yatiya qillqata ullma, ukatha uñt'ata arunaka muyuntayma.



- Jichhuxa alirakiwa suni tuqina ukaxa jichhu uta utachañatakixa wakisiwa.

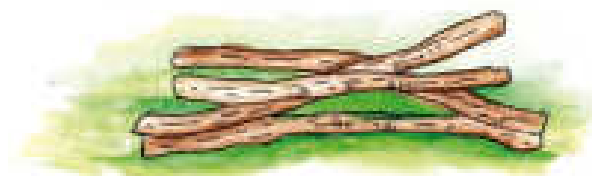

- Lawanakaxa quqanakathwa mistsu, ukanakaxa tijiralanakataki wich'usanakakiwa wakisi.

3. Qillqatana yatiyapa ullawsina jaysma.

- ¿Kuna yänakathsa yatiyasi qillqatanxa?
- ¿Wakisiriti sapa qillqata yatiyañaxa? ¿Kunathsa?



Arunaka qillqañatakixa
aru jaljayanakampi
arunaka jikipyatayma.

4. Sapa aruna jaljayapa maya riximpi tupayma ukatha kikiya samimpi samichma.



chhu

ji

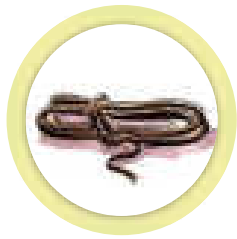

la

pha

5. Apnaqaña arunakampi wakiyataru phuqachma.

jichhu

--	--	--	--

phala

--	--	--	--

6. Akiri arunakampi



jichhu ukatha



phala sallanakapampi machaqa

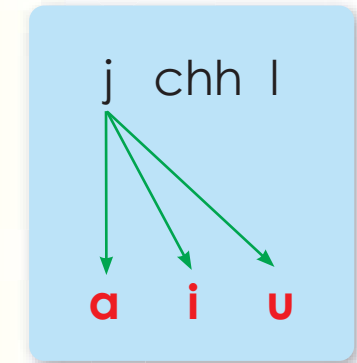

ja					uj
	chhi		achh		
		lu		il	

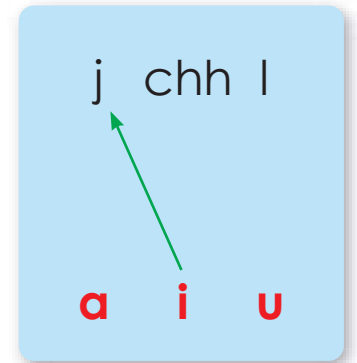

7. Jamuqanakana sutinakaparu uñt'ata aru jaljayatampi phuqachañäni.



chhiw _____



chhij _____



_____ chha



_____ llu



cha _____



_____ yu



_____ q'u



llu _____



_____ llu



_____ wi _____



_____ ku



_____ wi _____

8. Sixst'ma ukatha sutinakapsa qillt'arakma.

Empty rounded rectangular box for writing.

Empty rounded rectangular box for writing.

Empty rounded rectangular box for writing.

Empty rounded rectangular box for writing.

Empty rounded rectangular box for writing.

Empty rounded rectangular box for writing.

9. Akiri amuyuru arunakampi phuqachañäni.

Santikuxa wali aphana



luraski, jichhu



utachañataki.

Yatiqatasatha amuykipapxañäni

10. ¿Akiri yatiqawinxä kunsä yatiqt'awthanxa?



4 Laphi

Yatikipayasipxañäni

Yatiqañataki wakichasipxañäni

1. Jamuqa uñxatma ukhama jiskht'anakaru jaysma.

- ¿Kunsa jaqinakaxa jamuqatana lurapxi?
- ¿Kunatakisa luqt'asipxi simintawinxä?



Askipacha yatxatapxañäni

2. Wilamasimampi, masinakamampisa uta luraña tuqitha, yaqha yatiñanaka uñt'añatha aruskipma. Yatxatatamatha sixst'ma ukhamasa qillqt'arakma.

3. Yatirixa kunti yatiykchistu uka ull'ma:



Uta simintawinx
luqt'asipuniñawa
kunaymana yänakampi,
ukaxa k'uchi
utjasipxañataki ukhamaraki
kuna uthjiri yänakasa
utjapuniñapataki.



4. Utachaña yänakxata aruskipañani.

5. Janira aruskipkasina, kuna yänakatixa utachañatakiki ukanaka samichma.

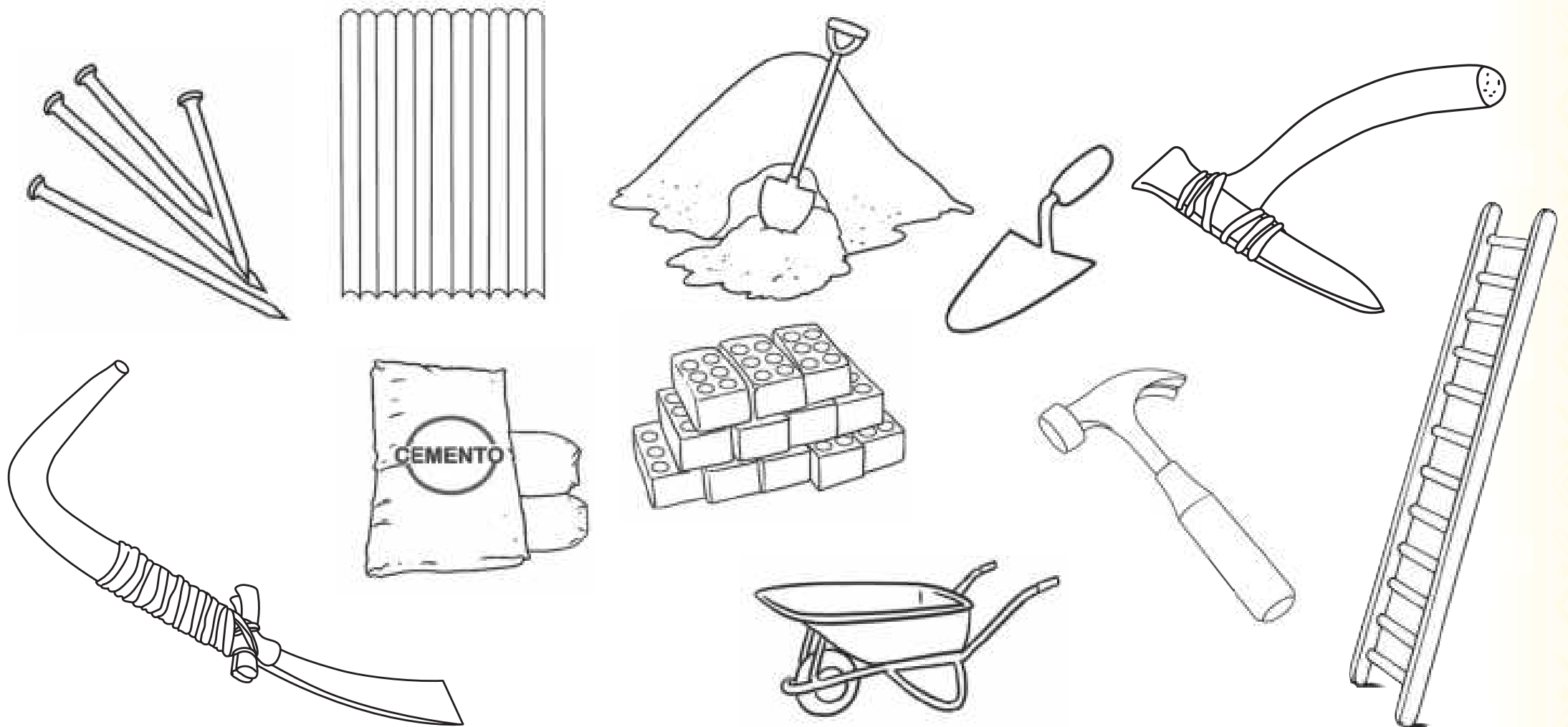

6. Masinakamampi aruskipma.

- ¿Kunjamasa yänakaxa? Sapa maya yänakatha yatiyima.
- ¿Kunatakisa wakisi? ¿Kunjamasa apnuqaña?

7. Aruskipawinxaxa, sapa yänakana samicht'atama arst'asa yatiyima.



8. Masinakamampi aruskipawasina, jumana ukankatama uñakipma. Siqtma luratanakama.

¿Jach'ata ukhamarusa qhana arumpiti arsuwaytha. Yänaka tuqitha aruskipawinxaxa?

Jisa

Janiwa

¿Yatiqiri masinakajana iwaxanakapa askti ist'awaytha?

¿Nayaru wakt'kitäna uka pachati arsuwaythxa?

Yatiqatasata amuykipapxañäni

9. Kutiyima.

- ¿Kunsa amxasiñasaxa, maya aruskipawina chikañäni uka pachatakixa?

Lurataja uñt'ayaja

5 Laphi



Yatiqañataki wakichasipxañäni

¿Munastati wila masinakamaru ukhamaraki masinakamarusa, taqpachani lurawina yanapasipthana, ukathxa?



¡Mä yatiya qillqapxañani ¡

Askipacha yatxatapxañäni

1. Qillqt'añataki wakichasipxañäni.

¿Kunsa qillqañänixa?

¿Kuna tuqithäpachänisa?

¿Khititakisa qillqañänixa?

2. Uta utachawinakana kunathsa janiki aynisxapxi, mink'asxapxarakisa uka tuqitha qillqt'ma ukhamaraki sixst'arakma.

3. Uta utachawinakana kunathsa chhaqtirjamäxpacha yanapisiwinakaxa uka tuqitha mä yatiya qillqt'ma.

Blank writing area with ten horizontal dashed lines for text entry.

Aru qillqatamxa
samichasmawa
suma
k'anchachata
uñjasiñapataki.



4. Yatiyama masinakamaru ukhamarusa wilamisanakamaru uñxatayma, ukatha juk'ampi khusachañataki iwxañaka katuqma.

Yatiqatasatha amuykipapxañäni

5. Jaysma.

- ¿Kunaka qillqatamana yatiyamana qhantayiripaxa?

Blank writing area with one horizontal dashed line for text entry.

Ch'umi suyuna utachasiwinakapatha yatxatapxañäni

6 Laphi



Yatiqañataki wakichasipxañäni

1. P'iqinchapa ullawsina jiskt'anakaru jaysma.

- ¿Kunxatsa qillqataxa yatiypachistäni? ¿Kunasa kamachpachäni?

Askipacha yatxatapxañäni

2. Akiri qillqata ch'ujuki ull't'ma, qhipxaruxa wilamasimataki ukhamarusa yatiqiri masimatakisa jach'a kunkatha ull't'arapma.

Ch'umi uraqinxä kunjamsa utachapxi uka uñt'apxañäni

Ashaninka markachirinakaxa wawanakaparuwa utachañä yatichapxi.

Chachanakaxa lrapay ukwa utachañataki wakichapxi.

Alwa qhara qharawa juch'usa, thuru lawanaka ch'umitha apsunipxixa.

Lawaxa waña, ch'ullqhi, jani laq'unakani ukhamañapawa.

Utachawinxä wilamasinakapampiwa yanapt'asipxaraki.



3. Masinakamampi aruskipma, ukhama jiskht'anakaru jaysma:

- ¿Kawki markathsa qillqata yatiyaxa arxaychistu? ¿Kunjamsa uksaxanakanxa utachapxäna?

Yatiqatasatha amuykipapxañäni

4. Ch'umi uraqina Suni suyunsa kunjamsa utachapxi, uka tuqitha sixst'ma.

Suni suyuna

Ch'umi uraqina

5. ¿Kunasa kikipäpacha jiwasana, ukhamarusa yaqha markamana utachasiña tuqithxa? Sixst'ma ukhamasa qillqt'arakma.



Yatiqatasatha amuykipapxañäni

6. ¿Kunsa yatiqawthanxa ch'umi tuqina utachasiwithxa.

Uta utachaña yanapt'asipxañäni

10^{ri}

Yatiqawi



Aski wakisiri utjirinaka:

Jichha phaxsinxa jaqichasirinakaxa wilamasinakapampi uta utachasiñankapxiwa, markansa ayllunsa, junt'u phaxsiwa, sasawa utachaña ch'amtapxixa.

Yaqhipa ayllunaka aynisa mink'asa utjaskiwa, yaqhipanakana pisipxarakiwa, yamasta maka chiqanakana qullqimpi mink'asa mink'asitakixiwa, walja urunakawa jupanakaxa uta lawkhapxixa utachapxixa, sumachapxixa, ukaxa wamphi qullqitakiwa.

Jamuqa uñxatasa kutt'ayma:

1. ¿Kuna lurañanaksa jamuqatanxa markachirinakaxa lurapxi?
2. ¿Jumasti ukankawtati? Yatiyma.



Ch'amt'añasa:

Aylluna markana utachawinakatha yatxatäsinxa: ¿Kunjamsa utachawina kunaymana yanapawinakxata mayninakaru yatiysnaxa?

Lursuña: Kunjamäskisa utachawinakaxa ukatha mä jawari qillqma.



1 Laphi

Kunjamsa utachaña yanapt'asiñataki aynimpi mink'ampi ch'amañchapxirixnaxa

Yatiqañataki wakichasipxañäni

1. Jamuqa uñxatawsina jaysma.

¿Jamuqatanxa kunjamasa utaxa?





Askipacha yatxatapxañäni

2. Yatichirina ullt'atapa ist'ma, ukatha luk'anamampi arkayasina ullataparjama arktma.

Mayja utachasiña uñstayxapxi

Ayllunakanxa yänakawa utachañatakixa apthapita ukhamarakiwa irnaqañatakixa aynisita, mink'asita.

Ukhamarusa jichhürunakanxa ukhama  utachasiñasaxa niya armatakixiwa; utachaña yatiri jaqirukiwa qullqimpi thaqatäxi, taqi kunasa  qullqikixiwa. Nayra yatita lurasinakasaxa chhaqtirjamakixiwa.

Ukhampachasa yaqhipa ayllunakana yanapt'asiñaxa utjaskapuniwa, uka taqinisa ch'amañchañäpxthanwa.

3. Ullawasina jiskht'anakaru jaysma.

- ¿Kunjamsa utanakaxa utachasi ayllunakanxa?
- ¿Kamachasphasa jani aynixapxsna jani mink'asxapsna ukjaxa?
- ¿Kunathsa utachawinakana khuyapayasiñaxa pisi amtatakixpacha?

4. Yatichirimampi wilamasimampisa aruskipma, jiskht'anakaru jaysañataki. Amuyatama (X) ukampi chimpuntma.

- ¿Kawkchhapiri ayllunsa suma sartañatakixa kawkchhapiri lurawinakasa askixa?

Ayni, mink'a.

Sapa sapa kunasa luraña.

- ¿"Qullqitakixiwa yanapayasiñasa" ukaxa askipachati?

Jisa, kunathtixa
qullqikixañapawa kunasa.

Janiwa, aynisiña mink'asiñaxa
walwa yanapchistasphaxa.

- ¿ Ayllusana jakasiwinxa masinakasaru utanaka utachawina jani yanapasiñaxa askipachati?

Qillqt'ma.

5. Wilamasimampi yatxatma, aynisiña mink'asiñaxa chhatapunisphati janicha, uka tuqitha aruskipasa. Ukatha qillqt'ma ukhama yatxatatamatha sixst'arakma.

Handwriting practice area with blue dashed lines and a yellow sticky note with a pencil icon.

6. Yatiqiri masimaru jani ukachaxa wilamasimarusqa qillqatama ukhamasa sixsutama yatikipayma.

Yatiqatasatha amuykipapxañäni

7. Jiskht'anaka ullawsina kutt'ayawima (X) chimpuntma.

• ¿Uta utachañanakana aynisiña mink'asiña pisi armt'atakixi, ukaxa askipachati?

Jisa

Janiwa

• ¿Kunathsa?

Handwriting practice area with blue dashed lines.

Uta utachaña yänakatha ullapxañäni



Yatiqañataki wakichasipxañäni

1. Jamuqa uñxatäsina masinakamampi aruskipma.

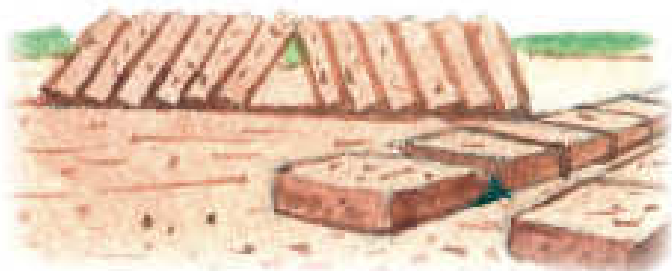

¿Kunjamasa aruwixa?
¿Kunatha luratasa?
¿Kunatakisa wakisi?

Askipacha yatxatapxañäni

2. Aruwi, qala uka utachaña yänakana yatiyapa ullt'ma.



Pikuxa lawallatha jirumpitha wakt'ayatawa, ukampixa aruwi lurañataki, uraqsa pht'snawa.



Qalanakaxa wali ch'ilawa uta simintañatakiwa wakisi.

3. Qillqata ullawsina, yatiqiri masinakamampi aruskipma, ukatha jaysma.

- ¿Kuna tuqithsa qillqataxa yatiyistuxa?
- ¿Kunathsa wakisi utachaña yänakatha yatxataña?



Achachilaxa utapa utachañataki yänaka wakichaski.

4. Jamuqatampi qillqatanaka tupayma.



qala

piku



5. Jamuqatana sutinakapa muyuntayma.



qala	qallu	QALA
<i>qala</i>	qamaqi	
punku	piku	juku
PIKU	<i>piku</i>	

6. Wakiskiri aru jaljanakampi arunaka phuqañchma.

qa pi la ku





qala

piku

qa	
	ku



7. Sixsutanakana sutipa wakisiri uñt'atha aru jaljanakampi phuqachma.

___q'i

___la

___ku

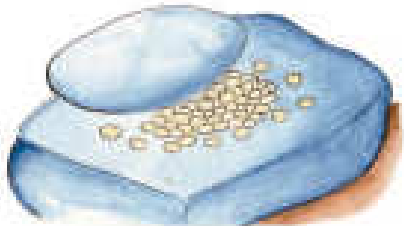
___qa___

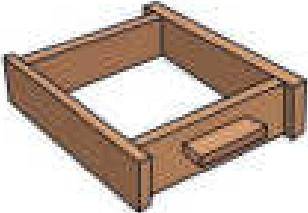
chhu___

___ru___ra

Wakisiri
sallanakampi
phuqachma.



8. Arunaka ull't' ma ukatha uñ't'ata sallanakaru muyuntayma.



ji chhu

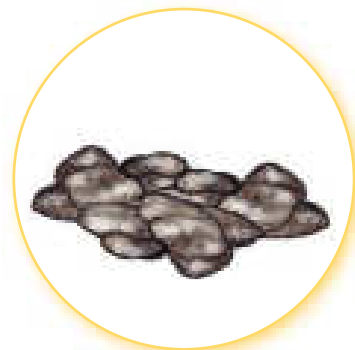

qa la



pi ku

9. Amuyunakaru wakisiri arunakampi phuqachma.

Achachilajaxa



utachasi, utatakixa kunaymana yänakawa

munasi:



ukhamanaka. Awichaxa manq'a phayaski utachirinakataki

wakichasi.



utachañakixa waljaniïpxiwa.

Yatiqatasatha amuykipapxañäni

10. Jaysma.

- ¿Kuna yänaksa wila masimaxa utapa utachasiñataki apthapisixa?

Maya wakiyata apthapinaka ulläsina qillqapxañäni (catálogo)

3 Laphi



Yatiqañataki wakichasipxañäni

¡Utachaña yänakatha yatiyapxañäni!



¡Maya wakiyata apthapitanaka ullapxañani!

Askipacha yatxatapxañäni

1. Yänakxatha qillqata ullapxañani.

Utachaña yänaka



Aruwixa laq'ampita ukaru jichhumpi ch'axltasna lurañawa.
Uta pirqanaka pirqsuñatakiwa wakisi.
Kunaymana jisk'a jach'awa.



Qalanakaxa wali ch'ullqi, jathiwa.
Apnuqasiwa uta utachañanaka qalltanakaruwa uskusi.
Khaya kantiranakanwa jilpacha jakxatasi.



Pikuxa aski wakisiriwa uraqi phat'añataki, yamasa uta lurañataki munasipuniwa.

2. Yänakana sutipa ullt'apxañäni, ukathxa sapa salla jaljayañäni.



qala

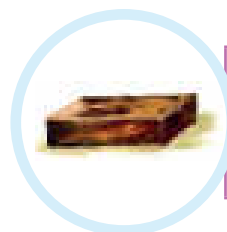

aruwi



jichhu



piku

3. Qillqataru wakisiri arunakampi amuyanakru phuqachma.

• Jilaja uta utachawiru



_____ apt'atawa aynisiri sarawi.

• Waynanakaxa



_____ pirqañataki



_____ lurasipki.

• Machaqa



_____ xa, wali sumallawa uñtasi.

4. Qillaqata arunakampi  qala,  piku, yaqha arunaka jaljatanaka wakiyañaru anatapxañäni, ukhama jaqha arunaka jakiñataki.

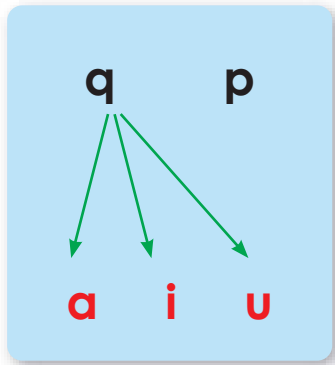

qa aq

 pi up

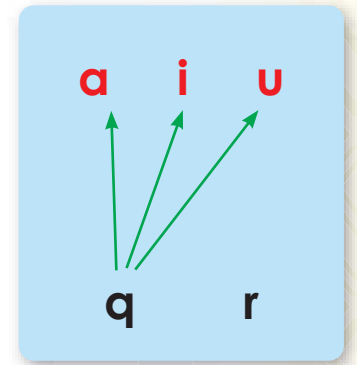

¡Samirana machaqa aru jaljanaka jakitapaxa wali khusawa!



5. Sixsutanakana sutipa wakisiri sallanakampi phuqachma.



_____llu



qaw_____



_____wa



qa_____



jiw_____



_____cha_____



_____ka



pir_____

6. Qillqatanaka phuqachma.



_____ mpi



_____ mpi

ukhamawa jaqinakaxa

utachapxi,



utachañaruxa jak'ankiri ayllu

masinakaxa



_____,



_____ ukhamasa



_____ aptaniña

yanapt'apxixa.

Jaqinakaxa



_____ utachañataki



_____ sipki,

ukaruxa mä



_____ wa

sayt'i. Ukhamaxa jank'akiwa

utachsusixa.

Yatiqatasatha amuykipapxañäni

7. Jaysma.

- ¿Kunjamsa machaqa arunaka ullaña ukhamarusa qillqaña yatiqthansti?

Yatikipayasipxañäni

4 Laphi



Yatiqañataki wakichasipxañäni

1. Jamuqa uñxatäsina jiskht'anakaru jaysma.

- ¿Kunasa sixsutanxa uñiyasi?
- ¿Kunathsa utachaña yänaka jilt'pacha?
- ¿Kunsa yatiyistu kunapachatixa utachaña yänaka jilt'ki ukaxa?



Askipacha yatxatapxañäni

2. Wila masimampi ukhamarusa yatiqiri masinakamampi aruskipäsina, utachaña tuqitha yaqha yatiyanaka amtma. Kuntixa sapktama uka sixst'ma ukhama qillqt'arakma.

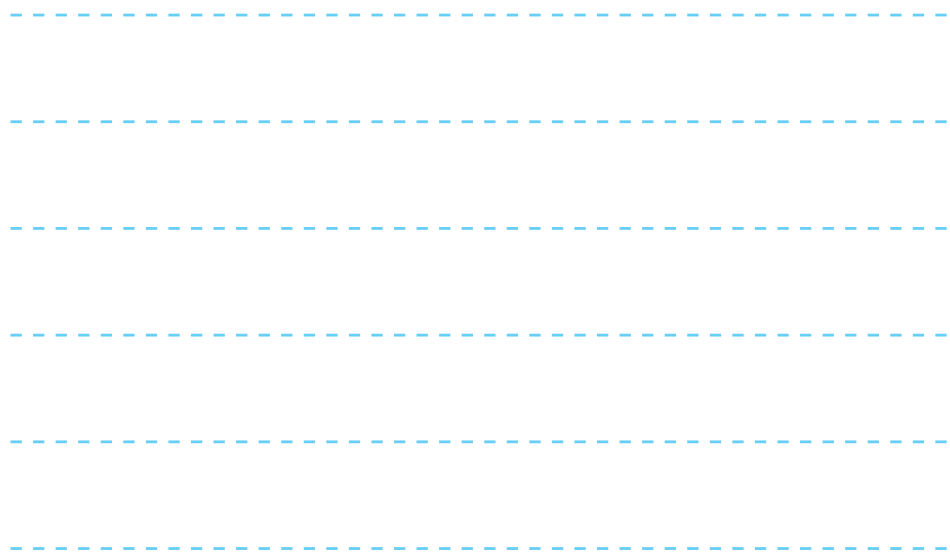

3. Yatirixa kunti jiskchistu uka ullt'ma.



Kunapachatixa utanakasa utachasthanxa, uka tukuyanxa yänaka jilt'i ukaxa yatiyasiwa, uka utana utjasirinakaxa suma k'uchiwa wilamasinakapampi ayllu taypina utjasini, uka saña munixa.

4. Yatiqiri masinakasaru yatt'ayapxañäni.



5. Janira yatiykasa, aka yatiya ullt'ma.

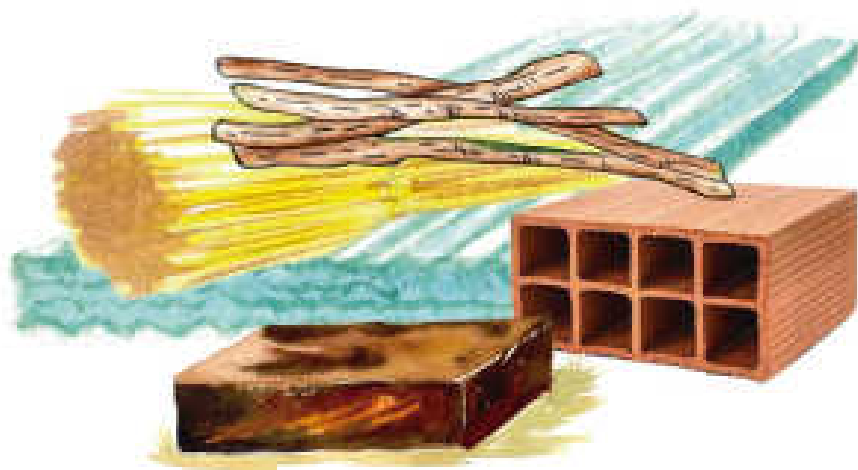

¿Kuna tuqithsa yatxataña munasmamaxa?



Aymara markanxa aylluna utjkiri yänakampiwa utanakasa utachasipthanxa.

6. Yatxatañataki yatichirimampi wakichasipxma.

Kunjama apnaqañasa ukhamarusa kunjama luratasa, uka yatxatasmawa.

7. Yatxatawimatha arst'asisa ukhamaraki sixsutamampisa ukaya jisk'a qillqatampisa yanapt'ayasirakismawa.



Suti: _____

Kunatakisa wakisi: _____

Kunjama lurañasa: _____

8. Yatiyawsina, kunanaktixa yatiyawina lurtaxa ukanaka samichma.

Jach'atha ukhamasa qhana arsuwthxa.

Yatt'ayaja suma sarantaytha.

Yatt'ayawinxax aski qhananchañataki sixsutanakampisa yanapt'asthwa.

Masinakajana jiskht'anakaparusa jaysthwa.

Yatiqatasatha amuykipapxañäni

9. Kutt'ayma.

- ¿Kunasa askiñapaxa arsutampi yatt'ayawinxax?



5 Laphi

Lurataja uñt'ayaja

Yatiqañataki wakichasipxañäni

¿Munasmati wila masimaru ukhamarusa masinakamaru yanapasiñxata yatiyaña?



¡Maya jawari qillqapxañäni!

Askipacha yatxatapxañäni

1. Janira qillqasa, jamuqanaka uñxatma ukatha jawari qillqsuña yanapt'ayasiñataki sapaqata lurawi qhanañchma.

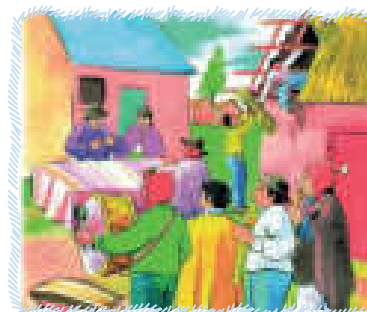
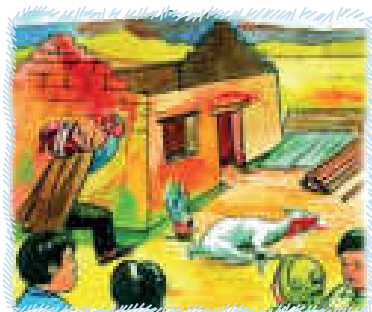

2. Qillqa wakichkipma:

¿Kunsa qillqañäni?	¿Kuna tuqithsa qillqañäni?	¿Khititakisa qillqañäni?

3. ¿Kamachasphasa aynisa mink'asa armatakixaspha ukjaxa? Uka yatxatäsina mä jawari qillqasma, ukathxa kuna lurañasa yäqañataki wakisispha, ukampina.

Blank writing area with horizontal dashed lines for text entry.

4. Wilamasimaru ukhamarusa yatiqiri masimaru jawari qillqatamatha yatiyma, ukatha iwxxanakapsa qatuqma, k'athampi khust'ayañataki.

Yatiqatasatha amuykipapxañäni

5. Arsuwimpi kutt'ayma: ¿Kunasa aka lurawina khusänxa? ¿Kunathsa?

Jawarima kawki chiqansa
taqini ullt'apxaspha ukawjaru
llip'katayma.





6 Laphi

Shawinakana uta utachasinakapa uñt'aphana

Yatiqañataki wakichasipxañäni

1. Janira qillqata ullkasa, jiskht'awinakarukutt'ayma.

- ¿Qillqataxa kuna tuqithsa arspacha? ¿Kunjamäpachasa Shawi aylluna utachañänakapaxa?

Askipacha yatxatapxañäni

2. Qillqata ullt'ma.

Shawinakana uta utachasiwipa

Utachañatakixa Shawi achachilanakaxa iwxt'asiñwa yatipxi; chachanakarusa lawa, phala, shapaja ukanaka thaqthapipxañapataki yatiyaraki.

Chachanakaxa utachaskäna ukawja pichthapipxixa, warminakaxa manq'añanaka, umañanaka yanapirinakaru waxt'añataki wakicht'apxixa.

Uta utachsutaruxa mayni yatiri achichilawa qullakipixa, uka uta wiñayañapataki, ukana utjirinakasa suma utjasiñapataki, ukhamaraki wilamasinakasa suma jakasipxañapataki.



3. Yatiqiri masinakamampi aruskipma, jiskht'awinakarjama jaysma:

- ¿Kawki chiqa jakawithsa qillqataxa yatiychistu? ¿Kunanakasa chachanakana warminakana lurañanakapaxa khaya Shawi ayllunxa?
- Shawi aylluna kunjamsa utachapxi, uka tuqitha sixsma.

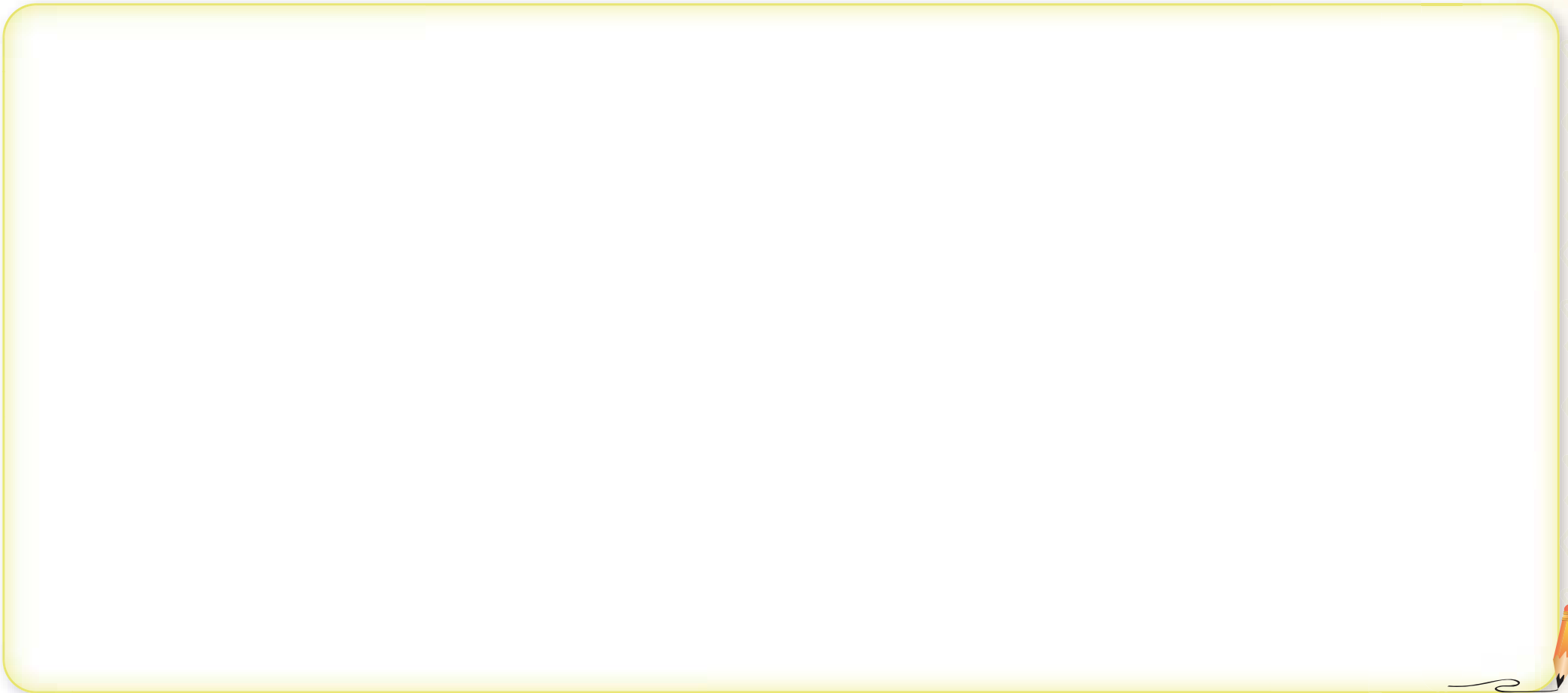

Yatiqatasatha amuykipapxañäni

4. Arsumpi kutt'ayma.

- ¿Shawi aylluna lurawipa tuqitha yatiqatamaxa munañjamati? ¿kunathsa?
- ¿Ayllumana, utachaña tuqitha kuna yatiwinakasa utjisti?



¡Anatapxañäni!

- Utachaña yänaka samichma.

k	a	l	a	m	i	n	a	y	ñ	t'	p
r	u	w	i	q'	t	a	h	i	r	j	i
j	i	c	h	h	u	q	x	i	q	k	k
u	w	r	a	t'	m	a	s	m	a	s	u
c	a	r	u	w	i	r	w	t	l	u	k
w	k	a	l	a	p	h	a	l	a	s	a
t	ñ	i	q'	i	u	n	k	a	m	i	t
a	j	l	a	m	q	t	x	n	s	t'	p'

- Sapa aru katjatama sixst'ma.

• Kalamina	Piku
• Phala	Aruwi
• Jichhu	Qala
• Ñiq'i	

6ri
T'aqa

Uywanaka uywachapxañani

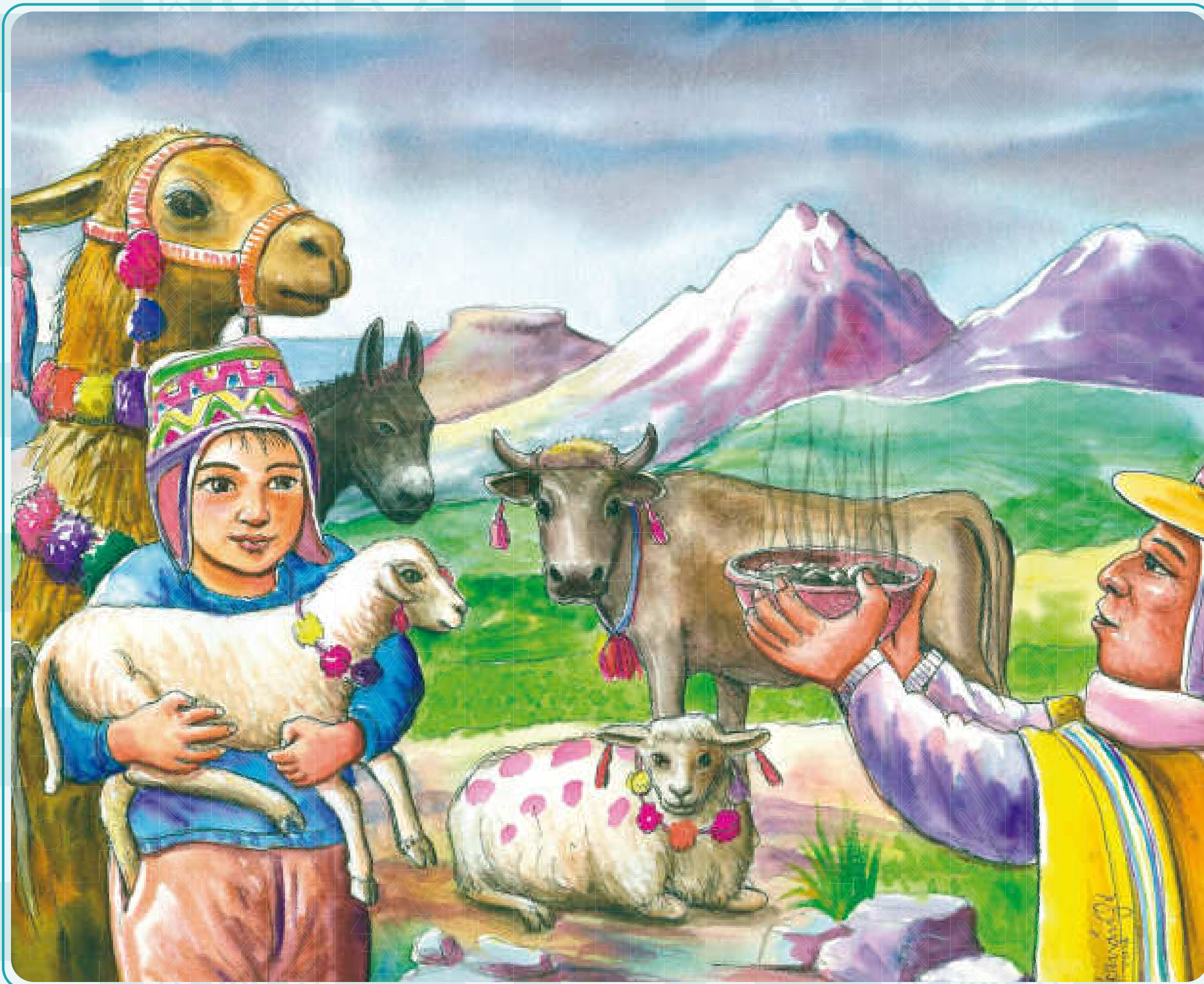

¿Kunjamäskisa ayllusana uywanaka uywachañaxa?



Aski wakisiri utjirinaka:

Jaya maranakathpachawa, markachirinakaxa kunaymana uywanaka uywapxiritayna akhama: qawra, allpachu, uwija, waka, yaqhanakampi. Kunathtixa uka uywnakaxa yapu lurañataki uywañasa wakisirakinawa, manq'añatakisa, ukhamarusa alxawsina qullqichañataki. Jichha pachanakanxa yaqhipa kasta uywanakaxa pisi uywatakixiwa, ukhamatha wilamasinakasa jani manq'ani jani qullqini uñjasxapxaraki.

Uñakipma ukatha kutt'ayma:

1. ¿Kuna luraña markachirinakaxa akiri jamuqana lurasipkisti?
2. ¿Ukhama luraña lurtati?



Ch'amt'añasa:

¿Kamachsnasa, wilamasinakaxa kunathsa pisiki uywa uywxapxi, uka yatxatäsina yatikipayañatakixa?

Lursuña: Wilamasinakaxa kunathsa pisiki uywanaka uywxapxi, uka tuqitha yatiyawini laphi lursma.

Kunathsa pisiki uywa uywachxapxi uka yatxatañäni

1 Laphi



Yatiqañataki wakichasipxañäni

1. Mayniri wilamasimaru jiskt'ma, kunathsa ayllumana pisiki uywa uywachxapxi, uka tuqitha sixsma.

Askipacha yatxatapxañäni

2. Akiri qillqata ullma.

¡Uywanakasaxa psikixiwa!

Juliku achachilaxa Intimpi, Mayampi allchhinakapampi jakisipxatayna uywanaka tuqitha aruskipañataki.

Jupaxa akhama amtasinaxa, nayra pachaxa jaqinakana wali khusapuniwa akiri uywanaka uywachapxäna: allphachu, qawra, uwija, waka, yaqha uywanakampi.

Yapu yapuchañataki, qullqichasiñatakisa t'awra saminakarjamawa ajllxapxäna, wansa tantapxäna, aycha alxapxäna. Ukhamarusa allphachunaka, qawranaka suma uywañataki kasta kasta lakjapxäna.

Ayllunakana wilamasinakasaxa kunaymana lurañatakiwa uywa uywapxarakina ukhamatha qullqinipxäna. Jichhaxa, janiwa uywxapxiti, niyasa awtunaka, tarakturanakaki apnaqxapxi, Ukhamaraki khumuña uywanakasa kikiparaki yuntanakasa janikiwa yäqataxiti.



Yatiqiri masinakamampi jani ukjaxa wilamasimampisa aruskipma, kamsañsa muni qullqichasiña ukhamasa kunathsa uywanakasa pisikixi, uka tuqitha.

3. Jiskht'anakaru arsuwimpi ukatha qillqatampi kutt'ayapxma.

- ¿Kunathsa uywanakaxa pisikixi?
- ¿Kunathsa uywanaka uywañasasti?
- Wakichataru kunanakathsa qillqathana yatiyawchistu, uywa pisiki uywxapxi uka tuqitha phuqachma. Qillqasma ukhamarusa sixsma.

Wilamasinakaxa kunathsa uywanaka pisiki uywachxapxi.

1 Kunathsa

2 Kunathsa

4. Wilamasimampi jani ukachaxa yatiqiri masinakamampisa aruskipma, ukatha kunathsa uywanaka uywañaxa pisikixi uka tuqitha yatxatma.

5. Yatxatatamatha sixsma, ukhama qillqasma.

- ¿Kasta kasta uywanaka qullqichañataki ukhamarusa manq'aniñatakisa wakisirifi uywachaña?

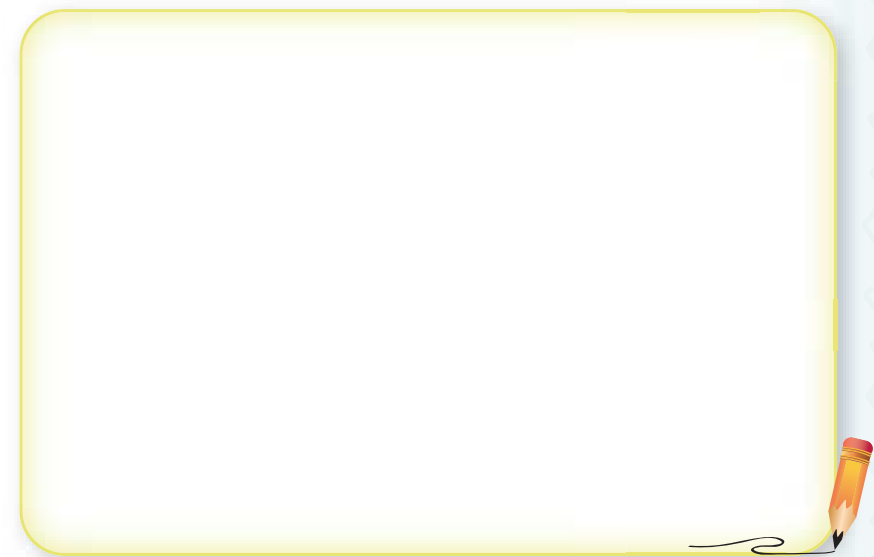

6. Masinakamaru jani ukachaxa wilamasimarusu qillqsutama ukhamasa sixsutama yatiyima.

Yatiqatasatha amuykipapxañäni

7. Jiskht'anaka ullma, ukatha kutt'ayawima samichma.

- ¿Kasta kasta uywanaka uywachaña qullqichasiñasataki?
- ¿Ukhamasa manq'aniñatakisa wakisiti?

Jisa



Janiwa



- ¿Kunathsa?



2 Laphi

Uywa uywaña yatiyawinakatha ullapxañäni ukhamasa qillqapxañäni

Yatiqañataki wakichasipxañäni

1. Yatiqiri masinakamampi aruskipma.

Awicha, ¿Kunathsa uywanakasaxa pisikixisti?







¡Maratha mararuwa, ayllunakasana suma kasta uywanakasa chhaqtaraki!



Askipacha yatxatapxañäni

2. Qillqata ullma.



Yatiyiri

Sata qallta phaxsina 20 urü saraqkiphana, 2022 maranxa, Kaylluma ayllunxa  qawra,  allpachu yawirañatakiwa mathapipxäna.

Ukathxa yatirixa Apu Achachilanakaru luqtapxäna. Allpachu , llamp'u ,  kuka ukatha winu ukanakampiwa, uywanaka

mirañapataki mayarakina. Maysa tuqinxä, kullakanakawa  qawra,  thaxa apthapiwinxa  p'isaqa thuqtayatayna.

Ukhamaruwa  t'awra alirinakaxa purinipxäwa, pisi qullqimpikiwa alaña munxapxarakina.

Ukhamipanxa, ayllu jaqinakaxa llakitapxänwa. Ukathwa Ayllu p'iqinchirixa: "Janiwa suma kasta,  t'awraxa alxasiñasati; qapupxañäni  ch'ullu,  chumpa p'itañataki, ukanakxa jila qullqiruwa aljt'asxañäni" sasawa ixwäna.



3. Jiskht'awinaka arsuwimpi kutt'ayma.

- ¿Kuna lurawithsa yatiyawixa jispacha? ¿Kuna pachansa, ukhamarusa kawkinkänasa?
- ¿Kunathsa ayllu jaqinakaxa alakipanakaru thuqumukuyapxänasti?
- Qillqatathjama, ¿kunatakisa ayllu jaqinakaxa mathapipxäna?

4. 363 laphinkiri lip'iyaña jamuqanakampi lip'xatayma: llamp'u, thaxa, ukhamarusa t'awra. Ukatha sutipa qillqasma.

5. Qillqatana kuna arunakfi uñ'taxa ukanaka muyuntayma.

p'isaqa – thaxa – qawra – allpachu – t'awra – uwija – qamaqi

6. Kawkintixa kikipa jiskixa uka samichma.

p'isaqa	llawi	LLAMP'U	llata	llamp'u
thaxa	thuxtu	thaxa	thaki	THAXA
t'awra	t'awra	t'aqa	T'AWRA	t'akuña



Suni wawaru qhanxatayata arunaka jaljtayañaru yanapt'ma. Apnaqaña qillqa llaphillanakampi anatma.

7. Arunaka ullma, ukatha sapaqata aru jaljtayaña mä muyumpi jist'antma, ukathxa uka jaljtayma.



p'isaqa



t'awra



thaxa

p'isaqa

--	--	--	--

t'awra

--	--	--	--

thaxa

--	--	--

8. Aru jaljtayata ma siqimpi aruparjama chikthapiyma, ukatha sixsuta aynacha chiqaparu qillqasma.



t'aw

tha

sa

qa



p'i

ra



xa



¡Ullapxañäni
ukhama amuyunaka
qillsupxañäni!



9. Arunaka jakitamampi amuyunaka phuqañchma llamp'u, t'awra, ukhamarusa thaxa.

-  _____ xa wali khusawa kunaymana luqtawinakataki.
- Mamajaxa qawra  _____ apthapiski.
- Allpachu  _____ xa taqi chiqansa wali yäqatawa.

Yatiqatasatha amuykipapxañäni

10. Arsuwimpi jaysma.

- ¿Kunatakisa yatiyawinaka ull'thana? ¿Kawkitha jutiri yatiyawinaka ullthana ukaya ist'thancha?



3 Laphi

Maya jiskht'awitha ullapxañani ukhamasa qillqsupxañani

Yatiqañataki wakichasipxañani

¡Aylluna p'iqinchiriru jiskht'awinakatha ullañani!



Askipacha yatxatapxañani



1. Aylluna p'iqinchiriru akiri jiskht'ayasiwipatha ullma.

Yatiyawi ulläsinxa, arunchirinakaxa aylluna p'iqinchiriparuwa jiskht'apxatayna.

Jiskht'iri : ¿Sutimasti? ¿Kawki ayllutätasa?

P'iqinchiri : Saturninu satäthwa, aymara ayllutarakithwa.

Jiskht'iri : ¿Kamachänasa ayllumana?

P'iqinchiri : Alakipanakawa purinisina: allpachu, qawra,  t'awra, ukhamarusa  thaxa, alxita sapxituwa, janiwa chanipsa churaña munapkituti.

Jiskht'iri : ¿Kunatakisa uywanaka lakjapxisti?

P'iqinchiri : Suma kasta kasta uywa lakjasina k'atampi mirayañataki uywasiñatakiwa, ukawa qullqichapxitu ukhamasa manqsa churapxituxa.

Jiskht'iri : Jichhaxa markachirinakaxa janiwa alakipanakaru alxapxaniti. Pay suma jaysawimatha.

2. Jiskht'awi ullawsina kutt'ayma.

- ¿Kunathsa aylluna p'iqinchiriru jiskht'apxisti?
- ¿Jumatakixa jiskt'awixa askiti? ¿Kunathsa?
- ¿Jiskht'awixa uraki suma uñjasiñataki wakisiti? ¿Kunathsa?

Jichhaxa jiskh'awina arunaka qhanañchata qillqañataki uka qillqata laphillanaka apnaqma.



3. Arunaka ullma, ukhama, sapa salla jani ukachaxa sapa aru jaljtayata wakichataru qillqma.



--	--	--	--

p'isaqa

--	--	--	--

t'awra

--	--	--	--

thaxa

4. Arunaka ullma, ukhama kikipa aru qillqatanaka mä muyumpi jist'antma.

p'isaqa	p'iq'i	p'asanqalla	p'i qi	qaqa
t'aw ra	t'an t'a	t'a qa	mux sa	t'ax lli
tha xa	than tha	tha ki	xa xu	sa xa

5. Akiri qillqanakampi  p'isaqa  t'awra yaqha aru jaljtayatanaka uñstayañaru anatañäni.

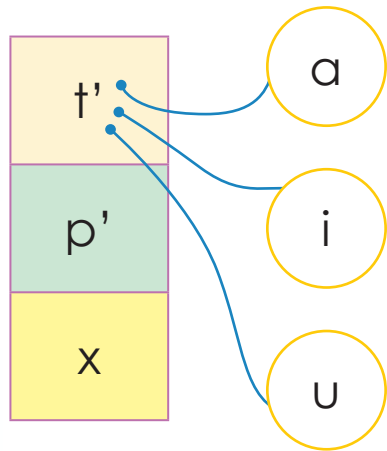

t'a			at'		
	p'i			ip'	
		xu		ix	

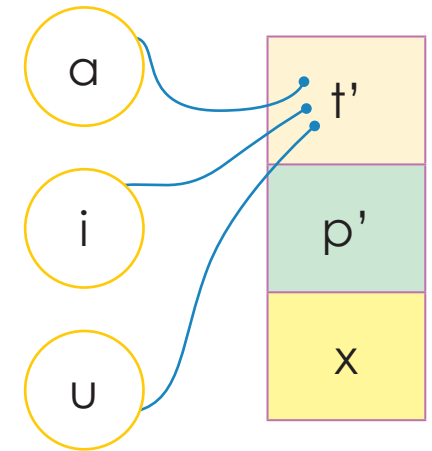

6. Yaqha sutinaka uñstayañataki uñt'ata aru jaljtatanakampi arunaka phuqachma.



q'i _____



_____ka



t'u _____

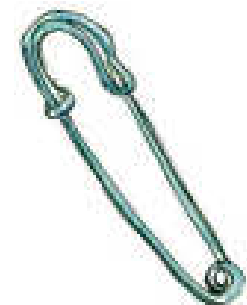

_____ri _____



_____sa _____



_____la





si _____



su _____ su _____

7. Machaqa aru jaljtatanaka jakitamampi yaqha arunaka qillqma, ukhamarusa sixsurakma.

8. Uñt'atama arunakampi qillqataru phuqachma.

Mamajaxa qhaturu qawra llamp'u aliriwa sarixa, puriniñsinxa qawra 
_____ apthapiñwa yanapitanixa, ukampi phayasiñataki. Tatajaxa
kullakajampixa  _____ qapuñataki suma t'isjapxäna.

9. Jaysma.

- ¿Khitinakasa mä jiskht'awinkapxi? ¿Kunatakisa jiskht'awixa lurasisti?



4 Laphi

Yatikipayasipxañäni

Yatiqañataki wakichasipxañäni

1. Jamuqa uñakipma, ukatha jiskht'anaka kutt'ayma.

- ¿Kunsa markachirinakaxa wawanakampi uñch'ukisipki?
- ¿Kunatakisa kunaymana uywanaka uywañasti wakisi?
- ¿Kunsa markachirinakaxa lurapxpachani?



Askipacha yatxatapxañäni

2. Wilamasimampi ukhamarusa yatiqiri masinakamampisa kuna luqtanakasa uywa mirañapataki luraña, jani ukachaxa lurasanakacha utji uka tuqitha aruskipma. Kuntixa sapktama uka sixsma, ukatha qillqma.

3. Awichaxa kunti jiski uka ullma.

Uywa aski mirañapatakixa
taki chuymampiwa
ch'uwañaxa.



4. Aylluna yatiriru kunanakathsa kunaymana kasta kasta uywanakaxa pisikixi uka tuqitha jiskht'añataki wakichma.

5. Jiskht'awi janira qalltkasa amtapunma:



- Yatiyiriru aruntaña.
- Sutipa jiskht'aña.
- Qhana ukhamarusa jisk'apacha jiskht'anaka wakichma.
- Yatiyiriru pay suma, ukhamsa sart'xajawa sapunma.

6. Jiskht'añamataki jiskht'anaka qillqma.

Handwriting practice area with five sets of horizontal dashed lines on a white background.

7. Jiskht'anaka qillqatampi ukhamasa iwxaanaka yäqasina, jiskht'asmawa.



8. Yatiqiri masinakamana jiskht'awinakapa wali isch'ukma.

9. Wilamasimampi jani ukachaxa yatiqiri masinakamampi jiskht'awinaka uñakipañataki mathapixma.

10. Jiskht'awimana kuna lurañanakti phuqta, ukanaka samichma.

Jiskht'ataru arunthwa.	Jiskht'ataru sutipa jiskht'thwa.	Jisk'a ukhama qhana jiskht'anakwa wakichthxa.	Jiskht'ataru wali ist'äsina jaysawinakapa qillqaqthwa.	Jiskht'awasina pay suma ukhamasa sart'xajawa sarakthwa.
------------------------	----------------------------------	---	--	---

Yatiqatasatha amuykipapxañäni

11. Arsuwimpi kutt'ayma.

- ¿Jiskht'irjamäñti jani ukaxa jiskht'ayasirjamäñcha muntasti? ¿Kunathsa?
- ¿Kunasa mä jiskht'awi luratasana askichañäsphasti?



Yatiqañataki wakichasipxañäni

¡Kunanakath,sa
uywanakaxa pisikixi uka
tuqitha qillqañäni!



¡Jisa, Yatiqiri masinakasaru
ukhamarusa
wilamasinakasaru
yatxatayañatakiniwa!

Askipacha yatxatapxañäni

1. Janira yatxataykasa, akiri wakichata amuyt'awiru phuqachañäni.

¿Kuna tuqithasa yatxatayawimasti?	¿Kunsa uywanaka pisikixi uka tuqitha yattasti?	¿Kunanakathsa uywanakasti ayllunakana pisikixi?

2. Kunanakathsa uywanakaxa pisikixi, uka tuqi uñt'ayma. Qillqma jani ukaxa sixst'ma.

3. Yatiqiri masinakamampi jani ukaxa wilamasimampi yatxatayañataki wakichasma, akirinaka yäqasina:

- Yatxatayawimana, jach'atha ukhamasa qhana arumpi amuyunakama aski sarayma.
- Amparanakamsa uñtanaksa apnaqapunma askiñapataki.



4. Yatichimarusa, yatiqiri masimarusu jani ukaxa wilamasimarusu iwxañaka ist'apunma.

Yatiqatasatha amuykipapxañäni

5. Arsumpiki kutt'ayma:

- ¿Uywanakaxa kunanakathsa pisikixi uka qhanti sasktha?
- ¿Kunatakisa yatiqiri masinakarun ukhamasa wilamasinakarusa yatxatayañasti wakisi?

Shawi aylluna chakuwipatha katuña

6 Laphi



Yatiqañataki wakichasipxañäni

1. Janira qillqata ullkasina, kutt'ayma.

- ¿Kuna tuqithsa qillqatasti yatiasphacha? ¿kunjamapachasa Shawi aylluna katuwipasti?

Askipacha yatxatapxañäni

2. Qillqata ullma.

Shawi aylluna katuña

Shawi jaqinakaxa wali katurinakäpxiwa, uywanaka katuñatakisa kunaymana sipitjañanaka uchañwa yatipxixa.

Jichha maranakanxa sipitjañanakapa ina mayakiwa uchxapxaraki, janiwa uywa katuñasa ina jasäxiti.

Wali ch'amawa sallqa uywanaka katuñataki jakiñasa, jani chuymani jaqinakawa quqanaka phichapxi, k'utsupxi ukhama. Uywanakaxa janiwa kawkina utjañsa yatxapxiti, ukhamathwa jichhaxa katuñasa wali ch'amäxiwa.



3. Yatiqiri masinakamampi aruskipma, jiskht'awinakarjama:

- ¿Shawi jaqinakaxa kunsá wali yatipxixa?
- ¿Kunanakathsa Shawi jaqinakaxa inamaya sipitanakapsa uchxapxixa?

4. Shawi jaqinakana katuwipa tuqitha yatiqatama sixsma.



Yatiqatasatha amuykipapxañäni

5. Arsuwimpi jaysma.

- ¿Yaqha ayllunakana uywanakapa tuqitha yatxatanaxa wakisiti? ¿Kunathsa?
- ¿Ayllumampina kuna lurawinakansa kikipaxa jani ukaxa mayjarkisti?

¿Uywanakasaxa kunathpunisa psikxisti?

12^{ri}

Yatiqawi



Aski wakisiri utjirinaka:

Jichha pachanakanxa janikiwa tama tama akiri uywanaka jakiñjamäxiti: qawranaka, allpachunaka, asnunaka yaqha uywanakampisa, uka uywanaka lanti muturani yänakakwa apnaqataxaraki, ukathpi khumuñanakatakisa chhajrañatakisa janisa uywanaka uywatäxarakitixa. Ukhamatha wilamasinakasa jani qullqini jani manq'añanisa uñjasxapxarakisphawa.

Kunanakathsa ayllusana uywanakaxa psikxaraki uka yatxatawasina akhamäniwa ch'amañchañasaxa:

¿Kunjamsa wilamasinakarü, kunasa kamachaspha uywanaka psikxiphana, uka tuqitha yatxataysnasti?



Lursuña: Ayllusana uywanakaxa kunjamäskisa ukatha mä jisk'a amuyu wakichañasawa.



1 Laphi

Uywanakaxa kunanakathsa pisikixi uka tuqitha yatxatapxañäni

Yatiqañataki wakichasipxañäni

1. Wilamasimampi jani ukaxa yatiqiri masimampisa aruskipma.



¿Kamachasphasa wilamasinakasa taypina jani uywa uywasxapsna ukjasti?





Askipacha yatxatapxañäni

2. Akiri qillqata ullma.

Asnumpi khullumpitha

Maya arumaxa, tata Julikuxa wanu khumuñataki  asnu mayt'asiri qurpatha qurpa thaqäna.  Asnu janiwa jakkänati, ukatha art'äna: "¿khitisa asnuni?", sasa.

Utaru kutt'äsinxa phuju jak'ana mä  khullu jip'intaskiri uñjäna, maya qalampi jaqutatañwa munarakinaxa, ukhamaruwa amtasina: "Uka uywaxa janiwa aliqa jiwayañäkiti, jachjitasphawa", sasa, ukhamawa  khulluxa thuqtayawasina sarxäna.

Utaparu puriwsinxä, warmiparu akhama sänawa: "Janiwa khitinsa asnuxa utjkiti, taqinisa awtumpi mutumpitakwa kunsä khumxapxi, janirakiwa alañjamäkisa,

ukhamarusa awtusa mutusa janiwa uka alaya tuqixa makhatkasphati.  Asnu alxatajsa amtasipunthwa, k'atakiwa kunsä khumurinxä!", sasa.

3. Jiskht'anaka arsuwimpiwa kutt'ayaja.

- ¿Kunasa kamachpacha uywanaka psikxañapatakisti?
- ¿Kamachasphasa wilamasinakati jani uywanipkaspha ukjasti?
- ¿Kunathsa uywanakatha jakasirithanwa, jistanxa?

4. Jamuqanaka uñakipma, ukatha kuna tuqithasa, uka qillqasma.

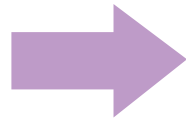

Blank writing area with a dashed line for handwriting practice.

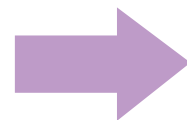

Blank writing area with a dashed line for handwriting practice.

5. Kutt'ayma. ¿Kunjamsa wilamasinakaru ñanqhachaspha, uywanaka psikixaspha ukjasti?

Large blank writing area with a dashed line for handwriting practice.

6. Kunanakampisa kamachasphaxa uywanaka wilamasimana utjasiñapataki psikixaspha ukjasa, kunasa wakisispha chiqachañataki, uka tuqitha wilamasimampi aruskipma. Wilamasimaxa kunti jisktama uka sixsma jani ukjasa qillqasma.

Kunanakampisa kamachaspha	Chiqachawi

7. Yatiqiri masinakamampi jani ukaxa wilamasimampirusa qillqatama yatikipayma, jani ukasa sixsutamsa.

Yatiqatasatha amuykipapxañäni

8. Jiskht'anaka ullma, ukatha kutt'ayawima chimpuntäsina (X) jaysma.

- ¿Uywanaka psikixiphanxa kunasa kamachaspha, uka tuqitha yatiñaxa wakisiti?

Jisa



Janiwa



- ¿Kunathsa?



Yatiqañataki wakichasipxañani

1. Wilamasimampi jani ukjaxa yatiqiri masimampi yatxatma.

- ¿Kuna uywanakasa chhaqtirjamaxa? Sixsma, ukhama sutipa qillqasma.

Yatiqatasatha amuykipapxañäni

2. Yatiyawini laphi ullma.

Uywanakasa uywapxañäni



Asnu,



qawra ukhamasa



allpachunakasa chhaqtasxakiwa!

¡Uywa uywasipuniñäni!

¡Asnumpi qawrampixa khumuñatakiwa!

¿Kunsa kamachsnasti?

JACH'A ARUSKIPAWI

Aylluna p'iqiñchirimpi

Kawkhankanisa: Aylluna utapana.
Uru: 20 uru anata phaxsi. Pacha: 10:00 alwa.

Uywanakasa chhaqtirjamawa

¡Janiwa armasitati!
Mä asnuwa surtiyasini.

¡, Khullu uka thuqtiri uywanakasa janiwa jiwayañati, chhaqtarakispawa!

3. Qillqata ullawasinxá wilamasijampi, ukhamarusa yatiqiri masinakajampiwa aruskiptha.

- ¿Kuna tuqithsa qillqataxa jisichitu? ¿Khititaki qillqatasa? ¿Kuna tuqithsa arxaychitu?
- ¿Kunathsa “Jach’a aruskipawixa” apasini?



Yatiyawini laphina qhanañchata sutinaka amtañaru yanapt'ma.

4. Mathapiwixa kuna sutinakti apani ukampi sixsuta chikthapiyma.

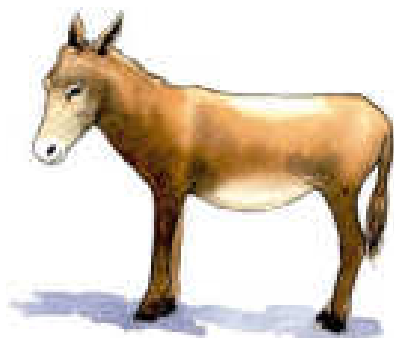

asnu

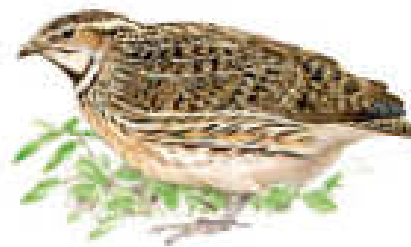

khullu

5. Nayraqatankiri kikipa arunaka samichma.

asnu	ASNU	suni	asnu	sanu
khullu	khunu	KHULLU	khumu	khullu

Maya wawaru
 arunaka aru jaljatampi
 phuqachaña
 yanapma.



6. Jamuqanakana sutipa ulläsina, aru jaljanakaparjama mä kajunalla samichma ukatha wakichatawjaru qillqampi phuqachma.



--	--

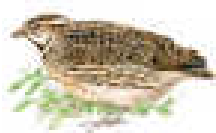

--	--	--



7. Jamuqanaka jani ukankiri aru jaljampi qillqsüsina sutipa phuqachma.



___kha

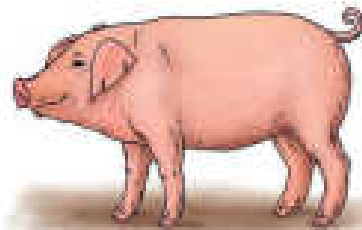

___chi



___nu



___ti



___na



qhu___

8. Arunaka ullma, ukhama uñt'ata aru jaljatanaka muyuntayma.



llan ti na



wir wi na



wis khu

9. Qillqata jani utjatapa arunakampi phuqachma.

Aylluna p'iqinchirixa akiri chhaqtirjama uywanakathwa aruskipixa, jisnawa:



_____ ,



_____ ukhamasa



_____ .

Uka uywanaka uywasipuniñasawa, ukhamarusa khullusa p'isqaqasa janiwa sinti jiwayañati, chhaqtarakisphawa, sasawa arxatäna.

Yatiqatasatha amuykipapxañäni

10. Arsuwimpi kutt'ayma.

- ¿Aylluna uywanaka chhaqtirjamiphana, uka tuqitha chiqachañasti wakisphati?
- ¿Kunathsa?

Ullapxañäni, ukatha mä yatiyawı qillqsupxañäni

3 Laphi



Yatiqañataki wakichasipxañäni



¡Achachilanakaxa
uywa uywañatakixa
wali yatiwinipxiwa!

Askipacha yatxatapxañäni



1. Aylluru sinti awtunaka mantawipa tuqitha yatiyawı ull'añäni.

Yatıyasiri

18 uru, sata qallta phaxsi, 2022 mara.

Aymara ayllunakana utjasirinakaxa mä ch'axwawıruwa mantapxäna, kunathtixa kunaymana jani uñt'ata awtunakawa ayllunakaru mantäsina alinaksa inaki takirpayxäna, uywanakarusä janiwa aski manqasiykänati, pastunakapsa q'añuchänawa. Ukatha jani sinti ukhamäñapataki marka p'iqiñchirıruwa mayt'asipxäna.



“Nanakaxa yatitäpxthwa  uywata khumusiñsa, jichhaxa chhaqtayañsa munapxaspha ukhamjamawa, mä tuqithxa , khullusa yaqha sallqa uywanakasa janikiwa utjxarakiti, chhaqtirjamakixiwa”, sasawa marka p'iqinçirıru qillqata laphinaksa luqkatapxäna.

Miércoles alwa 15 uru, sata qallta phaxsina, aka ch'axwawıxa apasina.

2. Sapaqatana sutipa qillqsuñataki jamuqanaka uñakipma. Ukathxa wakichataru sapa qillqa ukhamasa aru jaljatanaksa qillqma.

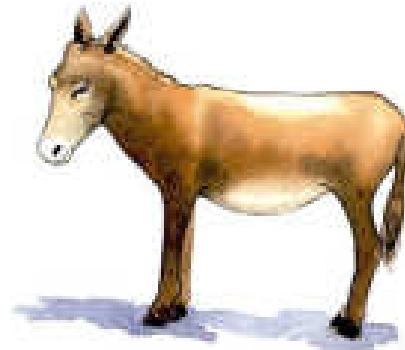

khullu

kh	u	ll	u
----	---	----	---

khu	llu
-----	-----



--	--	--	--

--	--

--	--	--	--	--

--	--

3. Amuyunaka jani ukankatapa wakisiri arunakampi phuqachma.

- Achachilajaxa tatajaru  _____ uywaru kunjamasa khumuñaxa uka yatichatayna.
- Awichajaxa  _____ k'awnaxa manq'añawa sarakiwa.
- Mamajaxa  _____ umayañatakiwa jiskharaki.

4. Aka arunakampi  asnu ukhamasa  khullu, machaqa aru jaljtayatanaka uñstayañaru, yaqha arunaka jakiñataki anatañäni.

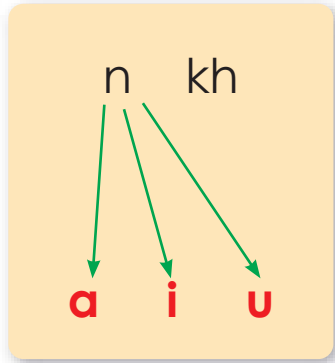

A row of six purple boxes containing the syllables: kha, [blank], [blank], akh, [blank], [blank]. Below this row is a row of six blue boxes containing: [blank], ni, [blank], [blank], [blank], un.

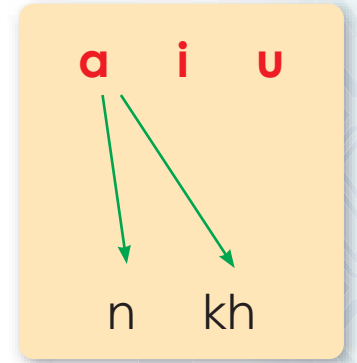

¡Waliwa Samira wawaxa yaqha aru jaljtayatanaka jakirakixa!

5. Aru jaljtayata jakitamampi arunaka phuqachma ukatha sutinaka uñstayma.



____ la



ch'an ____



wis ____



a ____



qi ____ ya



____ sa

6. Qillqatanaka phuqachma:

Santikuxa



jikkäsina,



khumuniñataki, sarkipanxa mä



_____ ruwa

thuqtayäna.

Inti wawaxa



lumaruwa awatiri saratayna

ukathxa



_____ wa

apstanxäna,



_____ wa

purxatani sasawa k'uchisina.

Yatiqatasatha amuykipapxañäni

7. Yatiqiri masinakamampi, jani ukjxa wilamasimampisa aruskipma, ukatha kutt'ayma.

- ¿Yatiyawinaka ist'aña ullañasa wakisiriti? ¿Kunathsa?
- ¿Machaqa arunaka ullaña qillqsuña kunjamsa yatiqthana?

Aruskipapxañäni

4 Laphi



Yatiqañataki wakichjasipxañäni

1. Jamuqa uñakipma, ukatha jiskt'anaka kutt'ayma.

- ¿Kunsa chachaxa samkasiski?
- ¿Kunsa yatiyistu warimpi samkasiñaxa?
- ¿Mä jaqixa kunatakisa warimpi samkasispha?



Askipacha yatxatapxañäni

2. Wilamasimampi ukhamarusa yatiqiri masinakamampi kuna yaqha uywanakampi samkasiñasa askiripacha, uka tuqitha aruskipma. Kunti sapktama uka sixsma, ukhamaraki qillqma.

Blank writing area with a yellow border and a pencil icon at the bottom right.

3. Yatirixa kunti jiski uka ullma.



Maya jaqiti warmimpi samkaschi
ukjaxa taqi kuna amtanakapasa
wali khusawa phuqasini.

4. Aylluna kunasa kamachaspha uywanaka chhaqtxapunispha manq'añanakatakisa, uka tuqitha aruskipañataki jawillma. ¡Jumawa yanapt'iritaxa!

5. Janira aruskipawiru mantkasinxaxa, akiri iwxañanaka amtma:

1ri Mayawja
uñanuqawma, ukhama,
urumpi pachampi
aruskipañataki.

2ri Taqini ukankañapataki
wakichma.

3ri Taqini
ukankañapatakiwa
wakichañamaxa,
ukhamasa askiñapataki.

6. Jutiritaki aruskipaña yatxataña tuqitha pä jiskht'awi qillqasma, ukaxa aruskipaña qalltañatakiwa.

Yatxataña tuqi

Jiskht'anaka

7. Aruskipawi pä jiskht'a qillqsutamampi sarantayma, ukhamasa taqi ukankirinakarusa arxatayma.

Aruskipawixa kunti yatxataña muntana uka tuqithäñapawa.

Mayni ukankirina jiskht' anakapa jutiriru jiskht' ayma.



Aruskipawinkirinakaxa kunjamsa qhanañchsa uka arusxatañapa iwixma.

8. Aruskipawi lurawasinxaxa, luratanakama samichma.

Jiskh' anakaxa amtata yatiqaña tuqinati.

Taqi ukankirinakaruti arsuyawthsti.

Arxatawijasti kuna chiqachaña taqi uñtaninati.

Taqi ukankirinakarusa askti ist'awthxa.

Yatiqatasatha amuykipapxañäni

9. Arsuwimpiki kutt' ayma.

- ¿Aruskipawinaka wakichañaxa askiti? ¿Kunathsa?
- ¿Kunsa arsuwija askiñapataki yatiqaskakiñajasti?



5 Laphi

Lurataja uñt'ayaja

Yatiqañataki wakichasipxañäni

Wilamasinakana
manq'asiñapataki uywanakaxa
chhaqtxaspha ukjaxa
kamachasphasa, ukanakatha
chuyma ch'allxanaka
amuyunaka qillqsuñäni.



¡Jisk'a amuyunaka
qillqsuñäni!

Askipacha yatxatapxañäni

1. Wilamasinakana manq'asiñanakapataki uywanakaxa chhaqtxaspha ukjaxa kamachasphasa, uka tuqitha jisk'a amuyunaka qillqsuñataki wakichma.

¿Kunsa qillqañäni?	¿Kuna tuqithsa qillqañäni?	¿Kunathsa qillqapxañäni?

2. Wilamasinakana manq'asiñapataki uywanakaxa chhaqtxaspha ukjaxa kamachasphasa, uka tuqitha paya jisk'a amuyu qillqasma.

Two sets of handwriting practice lines. Each set consists of a solid top line, a dashed middle line, and a solid bottom line, with a green mountain range illustration at the bottom of each set.

3. Jisk'a amuyunakama uñacht'ayma, ukatha askiñapataki iwzanaksa ist'ma.
4. Jiska amuyunakama mä yaqha samini laphiru qillqasma, ukatha k'anchachma.

Jisk'a amuyunakama qhanawjaru
llip'katayma, taqini ullt'añapataki.



Yatiqatasatha amuykipapxañäni

5. Arsuwimpi kutt'ayma:

- ¿Kunjamsa aka lurawi sarantaytaxa? Qhanañchma.



6 Laphi

Ashaninka uka markana uywa katuña

Yatiqañataki wakichasipxañäni

1. Janira qillqata ullkasa, amuyt'asa jaysma.

- ¿Kunjamsa ayllumanxa uywanaka katupxi?
- ¿Ayllunana kuna uywanaksa katupxi?

Askipacha yatxatapxañäni

2. Akiri uywa katuña tuqitha qillqata ullma.

Ashaninka uka markana katuña

Walja nayra maranakawa, Ashaninka jaqinakaxa uywanakaruxa wilamasipäspasa ukhamwa uñjapxänaxa, janiwa inasa katupkiñinati. Jichha pachanakanxa, manq'añatakikiwa katupxaraki.



Ashaninka jaqixa quqa quqa qulluru katuri sarañatakixa wakichasipxiwa, q'axchaña, machiti, kunaymana yänakampi uywampi chika utjanuqtañataki.

Ukhamasa chakuwiruxa jayu apapxaraki, katüsina jayuchañataki.



3. Ashaninka markana uywa katuwi qillqata tuqitha ull'awasinxa, kutt'ayawi (X) ukampi chimpuntma.

- ¿Kunathsa Ashaninka jaqinakaxa quqa quqa qulluruxa jayu apapxi?

a. Manq'añatakiwa munapxi.

ch.Uywa katupki ukaru jayumpi uchañataki.

4. Maya sixsüsina qhanañchma, "Ashaninka jaqinakaxa uywanakaruxa wilamasipäsphasa ukhamwa uñjapxäna", uka amuyu.



Yatiqatasatha amuykipapxañäni

5. Arsuwimpi Jaysma.

- ¿Kunsa Ashaninka markana uywa katuwipatha yatiqtasti? ¿Kunathsa?
- ¿Ashaninka markana ukhamasa ayllumampixa uywa katuwina kunanakansa kikipasa jani ukaxa mayjarakisa?



¡Anatapxañani!

Jamuqatanakana sutipa phuqachma.

A crossword puzzle grid with the following animal illustrations placed around it:

- Hummingbird (top left)
- Eagle (top center)
- Pig (top right)
- Sheep (middle right)
- Parrot (middle left)
- Chicken (middle center)
- Goat (middle center)
- Emu (left side)
- Buffalo (bottom center)
- Deer (bottom left)
- Alpaca (bottom center)

The grid consists of empty squares for letters, with some squares already filled by the animal illustrations.



Satawina suma qamarapxañäni



¿Kunjama satatäskisa yapunakasaxa?



Aski wakisiri utjirinaka:

Nayra pacha maranakathwa, ayllu jaqinakaxa aski kunaymana achuqanaka satapxiriña. Uraqinakasa yapu khuswa kunaymana achuqanaka achuqayiri jisnawa: ch'uqi, apilla, isañu, tunqu, siwara, yaqhanakamposa. Ukhamawasinxä jichhaxa uraqixa janikiwa nayrjamäxiti, jallusa janiwa pachaparu purxiti, ukatha juyranakasa janiwa pachaparu satatäxiti. Yaqhipa satirinakaxa janikiwa lumasankasa uñkapxarakiti, chanirusa jani chanirusa satatawapxakiwa.

Uñxatma, ukhama kutt'ayma:

1. ¿Kunsa jamuqankiri jaqinakaxa lurasipki?
2. ¿Aka lurawinxä yanapiritati? Aruskipma.



Ch'amt'añasa:

¿Kunjamathsa satawinakatha yatxatatasa mayninakaru yatikipayapsnaxa?

Lursuña: Yapunakasaxa kunjama satatäskisa uka tuqitha mä jach'a llip'iyaña laphi lursupxañäni.

Yapunakasaru kunjamsa satasipkthana uka tuqitha yatxatapxañäni

1 Laphi



Yatiqañataki wakichasipxañäni

1. Wilamasinakamampi jani ukaxa yatiqiri masinakamampi aruskipma.



Sataña pachankthanwa,
¿amuyusiptati?



Askipacha yatxatapxañäni

2. Qillqata ullapxañäni.

¡Janiwa khusa uraqixa utjkiti satañataki!

Aymara ayllunakanxa, nayra jallunakampiwa sataña qallantapxi. Nayrpacha jiwra phawañampiwa qalltaña ukxaruwa akiri achuqanaka satapxaraki jisnawa:  ch'uqi,  apilla ukhamasa ulluku.

Achuqanaka satañatakixa aka yänakawa wakisixa sañani:

lluku ukhamasa



yunta.



arma,



Jichhürunakanxa, ayllu jaqinakaxa kuna urusa satantasipkakiwa, yaqhipakiwa lumanaka uñchukisipkixa, ukhamarusa janikiwa nayra sata, taypi sata, qhipa sata ukanaksa aski sarayasipkiti.



Yatiqiri masinakamampi jani ukaxa wilamasimampisa kamsañsa munixa “nayra sata, taypi sata, qhipa sata” uka tuqitha aruskipma.

3. Yatichirimampi aruskipma ukhama jiskht'anaka jaysma.

- ¿Kunathsa yapunakaxa nayrijama jani pachaparu satatäxi?
- ¿Kamachsnasa uraqiru suma satañataki, ukhama walja achuñapataki?
- ¿Aymaranakaxa kuna achuqanaksa satapxi? ¿Kuna yänakasa satañataki wakisisti?

4. Amuyunaka ullma, ukatha chiqächixa (Ch) uchma, jani ukhamäkchi ukjaxa (J) uchma akiri qillqatanakana.

Markachirinakaxa k'ata achuqayañataki ukatha alxañatakixa jani aski qullanaka uchapxi.

Yapuchirinakaxa jani wakisiri pachaparuwa sapa marasa satapxaraki.

Yapuru satañatakixa janiwa lumasankaxa uñjapkiti.

Markachirinakaxa arma ukhamasa yunta ukanakampiwa satapxi.

Aymaranakaxa janiwa satapkiti.

5. Wilamasimampi kunathsa jani chaniparu satxapxi uka tuqitha yatxatma, ukatha aruskipma.

6. Yatxatatamatha sixsma, jani ukachaxa qillqsmasa.

Handwriting practice area with three dashed lines on the left and a yellow notepad with a pencil on the right.

7. Masinakamaru jani ukaxa wilamasimarusu qillqsutama sixsutama yatiyima.

8. Qillqatana qhanañchata arunaka samichma.



arma



yunta



lluku

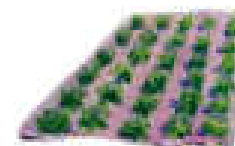

yapu

Yatiqatasatha amuykipapxañäni

9. Jiskht'anaka ullma, ukatha kutt'ayawima chimpuntma.

- ¿Uraqinakasana kunanakathsa jani wali satxapxi, uka yatiñaxa wakisiti?

Jisa



Janiwa



- ¿Kunathsa?

Handwriting practice area with a dashed line.



2 Laphi

Sataña tuqitha mä karta ullapxañäni ukhama qillqsupxañäni

Yatiquañataki wakichasipxañäni

¿Wilamasimaxa kunjamsa satapxi?



¡Maya karta ullapxañäni!

Askipacha yatxatapxañäni

1. Ajustinu achachilana kartapa ullma.

Arikipa, 25 uru taypi sata phaxsi 2022 marana.

Munata Kati imilla wawa:

Walikisiptaxa, nayaxa jumanakatha amtasipunthwa. Maya yatxatayaña munäsinwa qillqansmaxa.

Sataña pachaxa purinxiwa, ukatha uraqi wakichañwa munthxa, ukatakixa walja jatha, ukhamasa luraña yänakawa munasirakixa, jisnawa: jawasa, ch'uqi, apilla, ulluku yaqhanakampisa.

Yuntampiwa satajaxe, arma wakichasthwa, maya lluku apayanitasma, nayra utjirixa p'akisxiwa. Uraqinakasa qaritjama ukatha ch'apaqsutjamakiwa. Yapuxa inaxaya wali wanunchjatampi khusa utjarakchinisa.

Suma allchhi sart'awaja. ¡Uñjasipunma ukata k'ataki kutt'ayanita!

Juliku achachilama

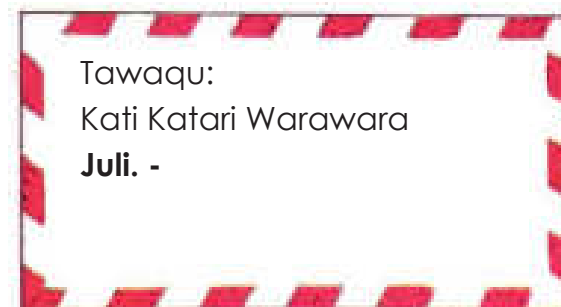

2. Karta ull'awasinxa, kutt'ayma.

- ¿Khitisa karta qillqixa? ¿Khitirusa qillqapxi?
- ¿Kunathsa kartaxa qillqasixa?
- Qhanañchma, kartana jisk'a amuyu jiskixa: “Yapuxa inaxaya wali wanuchjatampi khusa utjarakchinisa”, ukxata.
- ¿Ajustinu achachilaxa kuna yänakampisa achunaka satpachanisti? Aru ullma, 365 jakhu laphita llip'iyaña jamuqa llip'iqayma, ukhama chiqapawjaru llip'xatayma.

yunta

arma

3. Sapa jamuqana sutinakaparu muyuntayma.

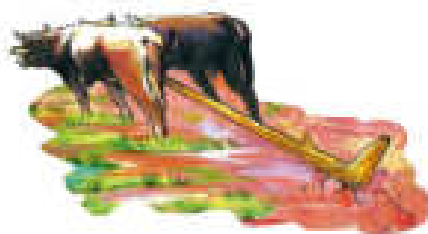

<i>yunta</i>	<i>yaya</i>	<i>yuku</i>
<i>yuru</i>	YUNTA	
mara	ARMA	mama
muraya	arma	



Isaku wawaxa satañataki
yänakana sutinakapa
jaljañaruwa anati.

4. Arunaka ukhamasa aru jaljtayatanaka ullma. Ukatha, chiqaparu chikthapiyma.

yunta

ar	ma
----	----

ARMA

arma

yun	ta
-----	----

YUNTA

Apnaqaña
arunakampi
wakiyma.

5. Sapa aruru jaltata arunakampi phuqachma.

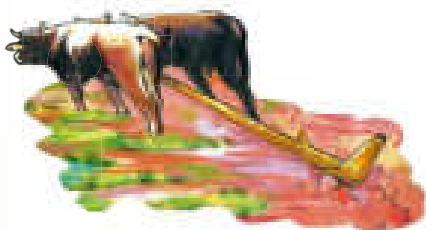

ar_____



ar_____



_____ku



6. Kikipa aru qalltaninaka samichma.

yunta	yapu	<i>yunta</i>	yuru	<i>yuqa</i>	YURIÑA
arma	<i>aruwi</i>	<i>aru</i>	<i>uru</i>	ARUMA	asuru

7. Jamuqa uñxatma ukatha wakichataru sutinakana sapasapa qillqapa qillqantma.



--	--	--	--	--	--	--	--	--	--



--	--	--	--	--	--	--	--	--	--

8. Arunakana qillqapampi: arma ukathxa yunta akiri wakichatana yaqha arunaka jakma. Jakitanakama qillsurakma.

a r m y u n t

p	t'	q	x	y	q'	n	p	a
a	r	m	a	q	u	r	ñ	r
s	w	r	i	l	l	u	s	K
i	a	i	T	y	u	n	t	a

1. _____

2. _____

9. Qillqatanaka phuqxatapxañäni.

Ajustinu achachilaxa k'uchiwa:



_____ ,



ukhamasa



_____ satixa.



_____ mpi, ukhamasa



_____ mpiwa sati.

Jusiya allchhipaxa



_____ uchañwa k'uchi yanaparaki.

Yatiqatasatha amuykipapxañäni

10. ¿Maya karta kunatakisa qillqathana? Karta ulläsina kuna wakisirinaksa jaktaxa mä qhawqha jisma.



3 Laphi

Maya jaysawi karta ullapxañäni ukhama qillqsupxañäni

Yatiqañataki wakichasipxañäni



¿Kunjamasa llukuxa?
¿Satañataki kunjamasa
armaxa wakichaña?

Askipacha yatxatapxañäni

1. Janira qillqata ullkasa, kutt'ayma.

¿Kunatakisa qillqata ullañäni?

¿Kuna yatxatawsa jakiñäni?

2. Qillqatanakana yatxatawipa ullma, ukhama uñt'ata arunaka muyuntayma.

Juli, 30 uru octubre phaxsi 2022 marana.

Munata achachila:

Kartama taypiha kunjamäsktasa uka yatiñaxa khusawa,
nayasa waliskaraktwa.

*Lluku mayista ukxa apayanisksmawa, arma, yunta
ukanakayri jumakiwa kunjamasa wakichanata.*

*Pachaparu satanata, mira suma: jawasa, ch'uqi, apilla,
ukhamasa ulluku. Janikisa uraqi laq'asa khusaxchiti.*

Yanapañamataki puriniwxajawa. ¡Suma uñjasipunma!

Kati munata allchhima.

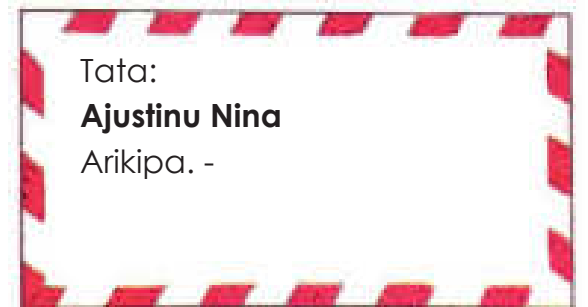



3. Qillqata ull'awasinxa, kutt'ayma.

- ¿Kuna pachasa kartaxa qillqasi? ¿Kawki chiqathsa kartaxa qillqasi?
- ¿Kunatakisa kartaxa qillqasi ukhamarusa khitisa qillqixa?

4. Jamuqanaka uñxatma, ukhama tuyuskiri aru jaljtayatanakamampi, sutinakapa qillqama.

llu ku ta yun ma ar



Below each illustration is a blue rounded rectangular box for labeling.

5. Arunaka uñstayañataki qillqanaka ajllma, ukhama maya siqimpi chikthapiyma. Apnaqaña qillqanakampi lurma.

Iluku

arma

yunta

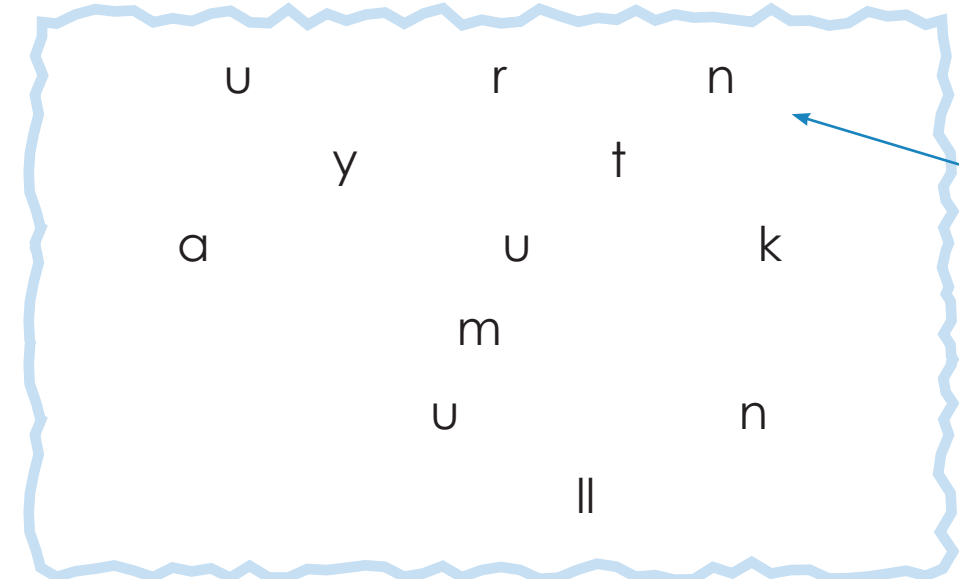

6. Akiri qillqanakampi  yunta ukhamasa arma , machaqa aru jaljtayatanaka uñstayañaru anatañani. Wakichata phuqachma.

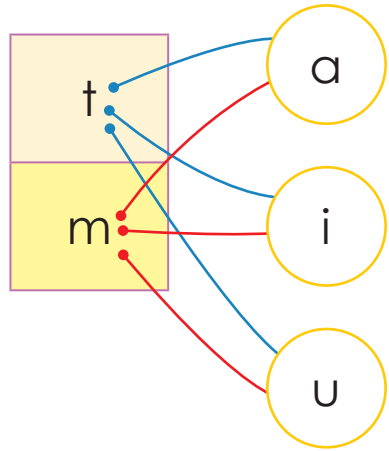

ta			at		
	mi			im	

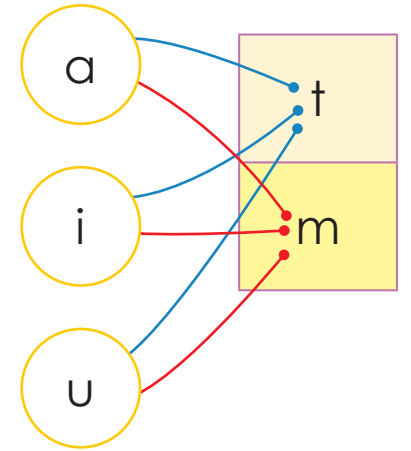

7. Jani ukankiri aru jaljtayatanakampi jamuqanakana sutinakapa phuqachma.



___ pa



___ ru ___



u ___



a ___ pa ___



Ja ___ ch'i

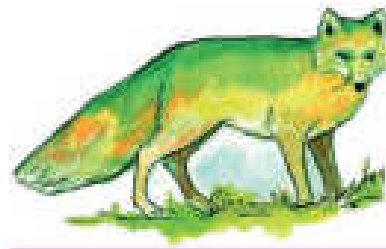

qa ___ qi



___ ri ___ ta



ki ___ la

8. Wakichatana sapaqata arunakampi amuyunaka qillqasma.

yunta

yuku

arma

9. Maya jamuqampi amuyu chiktapiyma.

Wilamasijaxa armampi
tunqu satapxi.



Achachilajaxa satañataki
yunta yapintaski.



Yatiqatasatha amuykipapxañäni

10. Arsuwimpi jaysañani.

- ¿Kuna yatiñasasa mä karta qillqsuñataki? Qhanañchma.



4 Laphi

Yatikipayasipxañäni

Yatiquañataki wakichasipxañäni

1. Jamuqa uñxatma ukatha jiskht'anaka kutt'ayma.

- ¿Kunathsa imilla wawaxa liqi liqi tapa uñch'uki?
- ¿Liqi liqina tapapa muqu patxankchi ukhamarusa jawira lakxankchi ukaxa kunsä yatiyasi?
- ¿Liqi liqi tapa taypina uwija thaxati jakisixa uka kunsä yatiyasi?



Askipacha yatxatapxañäni

2. Wilamasimampi ukhamarusa yatiqiri masinakamampi aski satapxañapataki, liqi liqina tapapaxa yaqha kunanakamposa saña munpacha, uka tuqitha aruskipma. Kunti sapktama uka sixsma, ukhama qillqasma.

3. Yatirixa kunti yatiyaski uka ullma.

Liqi liqiti muqu patxaru tapachaschixa,
jallu maräniwa jischituwa, tapati jawira
lakxankchixa, mach'a maraniwa sasiwa.
Uwija thaxati liqi liqi tapankchixa, ukaxa
ch'uqixa wali achuqanixa sarakiwa,
ukhamaxa walja ch'uqi satañasawa.



3. Kunathsa yapuchirinakaxa pisiki lumanaka uñkapxi, uka tuqitha aruskipapxañäni.

4. Janira aruskipkasinxaxa, yapunakaxa kunjama satatäskisa, uka tuqitha sixsma jani ukaxa qillqasma.

A large, empty, rounded rectangular box with a yellow border, intended for writing or drawing. It occupies the lower half of the page.

- Mayni masinakamampi mathapisipxma, ukhama kunathsa yapuchirinakaxa pisiki lumanaka uñchukxapxi, uka jisma.
- Sapa mayni mayakama kunanakathsa, uka ajllipxma, ukatha yatiqiri masinakamaru yatikipayma.

Nanakawa
ajllipxtha ...



Amtma:

Arsuñatakixa wakt'awima
suyañamawa.
Arsuña pachasa yäqañasawa.
Arsuriru aski ist'añawa.
Yatyawiw qhana arsuñasawa.

5. Yatiqiri masinakamampi aruskipawasinxaxa, lurawima uñakipasma. Ukhamaru luratanakama chimpuntma.

¿Yatyawiw qhana ukhamasa chiqapänati?

Jisa

Janiwa

Wakt'awijaruwa suytxa, ukhamasa pachsa yäqarakthwa.

¿Yatiqiri masinakajaruxa ist'thwa?

Yatiqatasatha amuykipapxañäni

6. Jaysma.

- ¿Aruskipañataki kunanakasa yäqañasaxa?

Lurataja uñt'ayaja

5 Laphi 

Yatiqañataki wakichasipxañäni

¿Ayllumana yapuchirinakaxa kunathsa pikisi lumasanka uñkapxi, uka tuqitha yatxatayaña munasmati?



¡Maya llip'iyaña yach'a laphi qillqsuñäni!

Askipacha yatxatapxañäni

1. Llip'iyaña laphi qillqsuñama wakichma.

¿Kunsa qillqapxañäni?	¿Yatxatayawixa kunäpachanisa?	¿Khititakisa qillqapxañäni?

2. Llip'iyaña lapphiru uchañataki, satawina walt'awipa tuqitha amuyunaka qillqma.



3. Sataña jani walt'awi tuqitha nayraqata jumana llip'iyaña laphima jamuqsuña yant'ma.

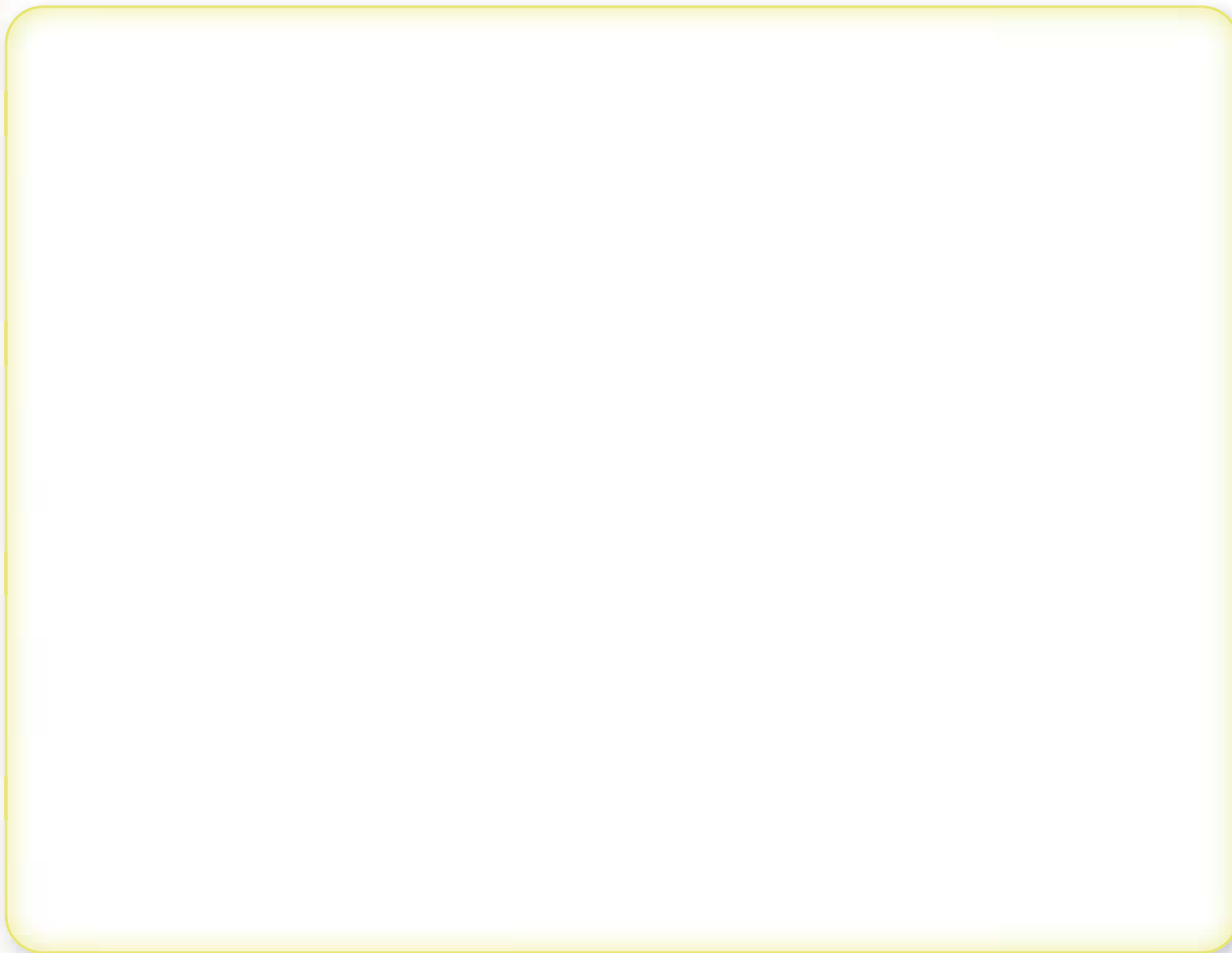

Llip'iyaña
jach'a laphiru
jambuqanaka
llip'katayma.

Kunaymana
qillqanakampi
ukhamaraki
saminakampisa
qillqama.



4. Uñakipma, ukatha iwxañaka churapktama ukampi yaqha samini laphiru llip'iyaña laphima qillqama. Uxaru aylluna mä qhanawja chiqaru llip'katayma.

Yatiqatasatha amuykipapxañäni

5. Kutt'ayma.

- ¿Llip'iyaña laphi qillqutamana kunasa chiqpacha amuyusti?

Yaqha ayllunakana satañanakapa tuqitha yatxatapxañäni

6 Laphi



Yatiqañataki wakichasipxañäni

1. Qillqatanakana jamuqanakapa uñxatma.

- ¿Qillqataxa kunathsa yatiypacha?, ¿Kawki aylluthsa arxayaspachani? ¿Kunatakisa qillqasupxpacha?

Askipacha yatxatapxañäni

2. Yatiqiri masinakamataki jani ukaxa wilamasimatakisa qillqatanaka jach'atha ullma.

Qhichwanakaxa walja sillq'unakati uraqi manqhana utji ukaxa ch'uqi, jawasa ukhamasa jiwra achuqanaka walja utjañapatakiwa, sapxiriwa. Qhichwanakana manq'anakapanxa ch'uqixa ukankapuniwa, jiwra k'ispiñusa ukhamaraki, kikipakiwa jawasa mut'isa.



Awajun ayllunxa, laq'ati ch'iyara ukhamasa ch'allanixa satañataki, wali khusawa. Jupanakaxa yuka lawa jach'añapataki satapxi. Awajun jaqinakaxa akiri manq'anakwa phayapxi, yuka phutsuta, yuka kanka, ukathxa yuka laphinakampixa kaltu phayapxi. Yukaxa kunaymana manq'ana phayatarakiwa.

3. Yatiqiri masinakamampi aruskipma, ukhama jiskht'anaka kuff'ayma:

- ¿Qillqatanakana kunathsa arxaychitu?
- ¿Qhichwanakaxa kunjamsa khusa achuqawa utjani uka yatipxi?
- ¿Awajun jaqinakaxa kunjamsa khusa yukanakaxa utjani uka yatipxi?
- ¿Qillqatanaka ullatama muntati? ¿Kunathsa?

4. Wakichata phuqañchma. Qillqasma jani ukaxa sixsma.

Jiskht'anaka	Awajun ayllu	Qhichwa ayllu
¿Kunjamsa khusa achuqa utjañapa yatipxi?		
¿Kuna manq'anaksa phayapxi?		

5. ¿Kawkchapi ayllusa k'atampi jumana ayllumjamaxa? ¿Kunathsa?

Yatiqatasatha amuykipapxañäni

6. ¿Awajun aylluna satañapa tuqitha kunsä yatiqthana?

Yapunakasana satañxata yatxatapxañäni

14^{ri}

Yatiqawi



Aski wakisiri utjirinaka:

Jaya maranakthwa, markachirinakaxa kunaymana achunaka satapxaraki. Satañatakixa puruma uraqiru, puruma laq'aru satatapuniwa, aski khusa, suma muxsa, jach'anaka ukhama achuqixa. Yaqha achuqanakayrixa qallpansa achukisphawa: apilla, ulluku, jawasa, jiwra qañiwa, yaqhanakampisa. Jichha pachanakanxa yaqhipaxa jani pachaparukiwa chanirusa jani charinusa satxapxi, ukawjatha amuykipañawa aski wakisiri.



Yapunakasaxa kunathsa jani aski pachaparu satatäxi, uka tuqitha uñ'awasinxa yaqha ch'amañchasina phuqañätanwa.

¿Yapunakasana pachaparu satawi utjañapataki kamachapxiñksnasa, uka kunjamsa yatxataysnasti?

Lursuña: Yapuchirinakaxa kunathsa jani pachaparu satxapxi, ukatha qillqsupxañäni.



1 Laphi

Sataña pachana wakisirinakatha yatxatapxañäni

Yatiqañataki wakichasipxañäni

1. Jamuqa uñxatma, ukhama kutt'ayma.

¿Kunjamasa
jamuqana
yapuxa?





Askipacha yatxatapxañäni

2. Yatichiramaru qillqata ullt'ki uka ist'ma, ukhama luk'anamampi qillqatkama arkma.

Sataña

Juwansuxa wilamasipampi satañataki wakichasipxi. Ukhamasa ququ phayañatakixa jayp'uthpachawa  **qhuna** chakilla patxaru uchäsina jiwra qhunapxäna, ukhamathxa muxsa k'ispiñu, thaxthimpi ququtaki lurapxäna.

Juwansuxa, yapu lurirjama, sänawa “uraqisa qaritawa ukhamasa ch'apaqsuta sapa marasa  **apilla** satatakiwa, ukathwa juk'aki achuqarakixa”, sasa.

Jichha maraxa janiwa apilla satañapäkiti, luranitixa juk'akirakiniwa, ukathxa wilamasinakaxa jani manq'ani ukhamasa jani qullqiniwa uñjasipxasphaxa. Ukhamaxa uraqixa wanuchjañawa  siwara ukhamasa  jiwra phawañataki.

Chuqixa puruma uraqinwa satasinixa. Ukhamawa uraqi ch'amañchasiñapataki, maratha mararu yaqha achunaka satañanakapaxa.

- ¿Kunanakasa kamachasphaxa jani satapksna ukjasti?
- ¿Kunathsa wilamasinakataki satañaxa wakisiristi?
- ¿Kamachasphasa pachpa achuki sapa marasa sataskaksna ukjasti?
- ¿Kamachasphasa achuqanakaxa juk'akispha ukjaxa?
- Lurañanaka ullma ukatha 365 jakhu laphitha llip'iyaña jamuqa llip'iqayma, ukhama chiqapawjaru llip'xatayma.

Juwansuxa sapa marasa pachpa uraqinakwa achunaka sataskixa.

Warmixa ch'uqi sataski, aski achuqañapataki.

Uraqixa ch'apaqsutawa kunatixa sapa marasa pachpa achukwa satasipki.

3. Kutt'ayma: pachpa uraqina walja maranaka ma achuki satsna ukjasti. ¿Kamsasma walja aski achuqanakanisnati?

4. Yatichirimampi ukhamarusa wilamasimampi yapuchirinaka jani chaniru sapa marasa satxapxaspha ukjaxa kamachasphasa, uka tuqitha aruskipma. Ukatha uraqinaka uñjaña yanapiri wakisiri lurañanaka chimpuntma.

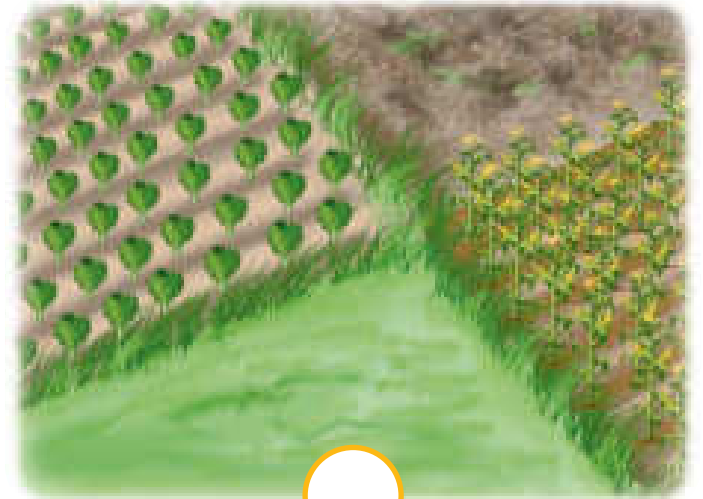

5. Maya luraña ajllma, ukhama masinakamaru, jani ukachaxa wilamasimaru, uraqinaka aski yäqañatha qhanañchma.

Yatiqatasatha amuykipapxañäni

6. Jiskht'anaka ullma, ukhama kutt'ayawima (X) chimpuntma.

- ¿Kunjamathsa chaniparu wasitatha satantapsnaxa, uka yatiñaxa wakisiti?

Jisa

Janiwa

- ¿Kunathsa?

Maya correo electrónico uka ullapxañäni ukhama qillqapxañäni

2 Laphi



Yatiqañataki wakichasipxañäni

¿Maya correo electrónico uka uñtt'ati?



Askipacha yatxatapxañäni

1. Juwansuna correo electrónico katuqatapa ullma.

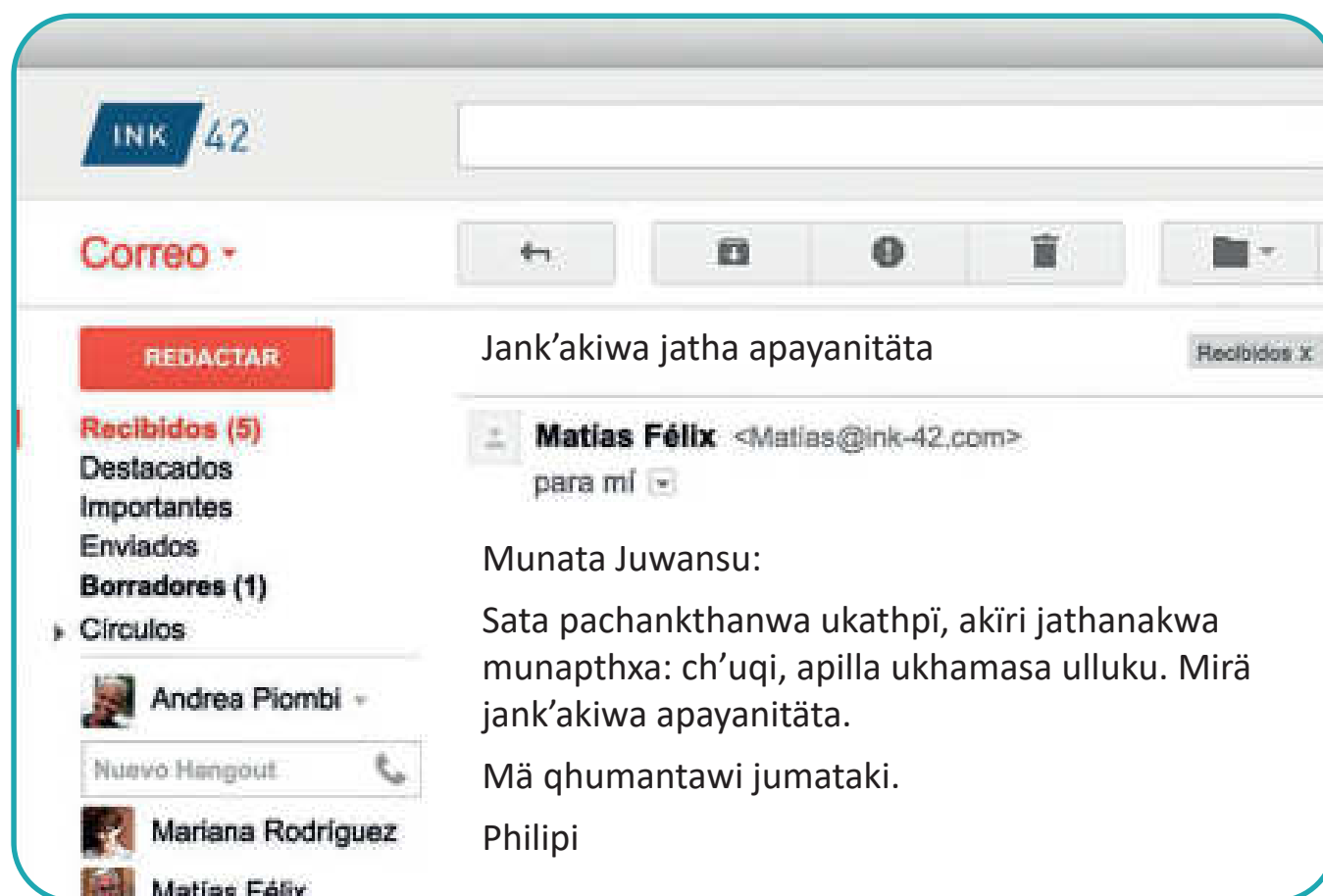

¡Correo electrónico ukanama walja jaqinakaruwa yatxatawinaka apayaraksnaxa!



2. Correo electrónico ull'tawasinxá, yatiqiri masinakamampi aruskipäsina kutt'ayma.

- ¿Kunathsa correo electrónico ukana qillqataxa yatiyasi? ¿Satañataki jathaxa wakisiripachati?
- ¿Kamachasphasa jani satañataki jatha ujtjaspha ukjasti?



Achachilaxa satañataki jatha wakichaski, sutinakapa jakiña yanapt'ma.

3. Jamuqanaka uñxatma, ukhama sutinakapa qillqasma.



4. Jamuqanaka uñxatma, ukatha sutinakapampi chikthapiyma.



qhuna

apilla



APILLA

QHUNA

5. Jamuqanakana sutinakapa jani ukankiri aru jaltayatanakampi qillqantawsina phuqachma.



____qi



a____lla



qhu____

6. Apnaqaña qillqanakampi yanapt'ayasisa arunaka qillqanakampi phuqachma.



apilla						
--------	--	--	--	--	--	--



qhuna						
-------	--	--	--	--	--	--

7. Qillqanakampi arunaka uñstayañäni "ch'uqi, apilla, qhuna".

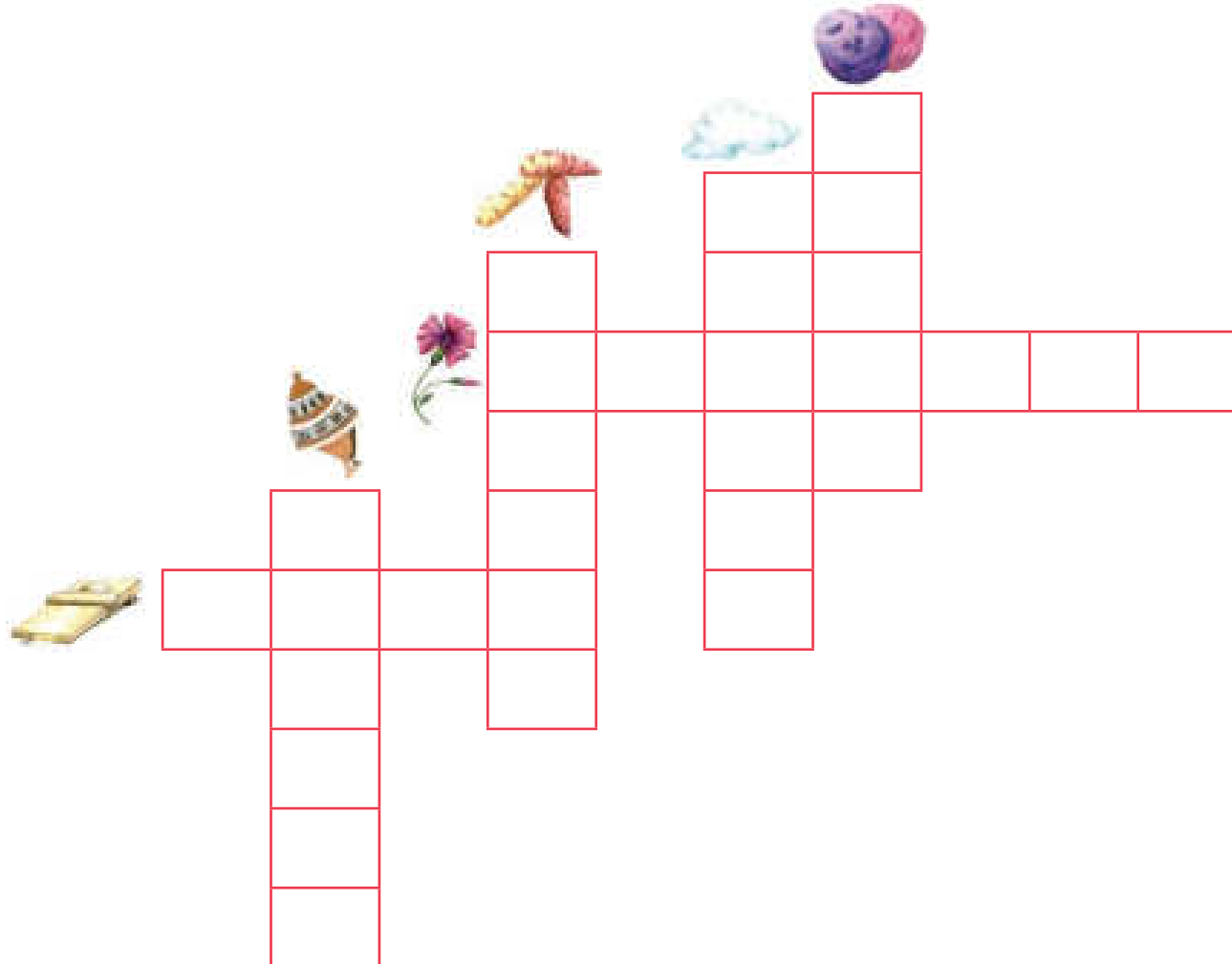

Ch'	a	u	qh	ll	q	n	p	i
-----	---	---	----	----	---	---	---	---





Wakichatana, jamuqanakana sutipa qillasma.



8. Qillqata uñstayañataki uñ'ata arunakampi qillqantma.

Achachilajaxa  _____ satixa,  _____ ukhamasa muxsa  _____, wilamasinakapampi manq'asipxañapataki.

Tatajaxa  _____ alasinitayna jiwra ukhamarusa qañiwa qhunañataki, ukatha _____ k'ispiña _____ ukhama  _____ phayañataki.

9. Jamuqanaka uñxatma, ukhama maya qillqa qillqasma.





Yatiqatasatha amuykipapxañäni

10. Kutt'ayma.

- ¿Maya correo electrónico uka taypinama yatikipayasipxsnati? Qhanañchma.

Satañxata yatiyawı qillqata ullapxañäni, ukhama qillqsupxañäni

3 Laphi



Yatxatañataki wakichasipxañäni

¡Santikuru, yapunkthwa saña munthxa!



¡Yatiyawı qillqata apayasmamaxa!

Askipacha yatxatapxañäni

1. Maya qillqa yatiyawına achunaka sataña tuqitha aruskipawı ullma.

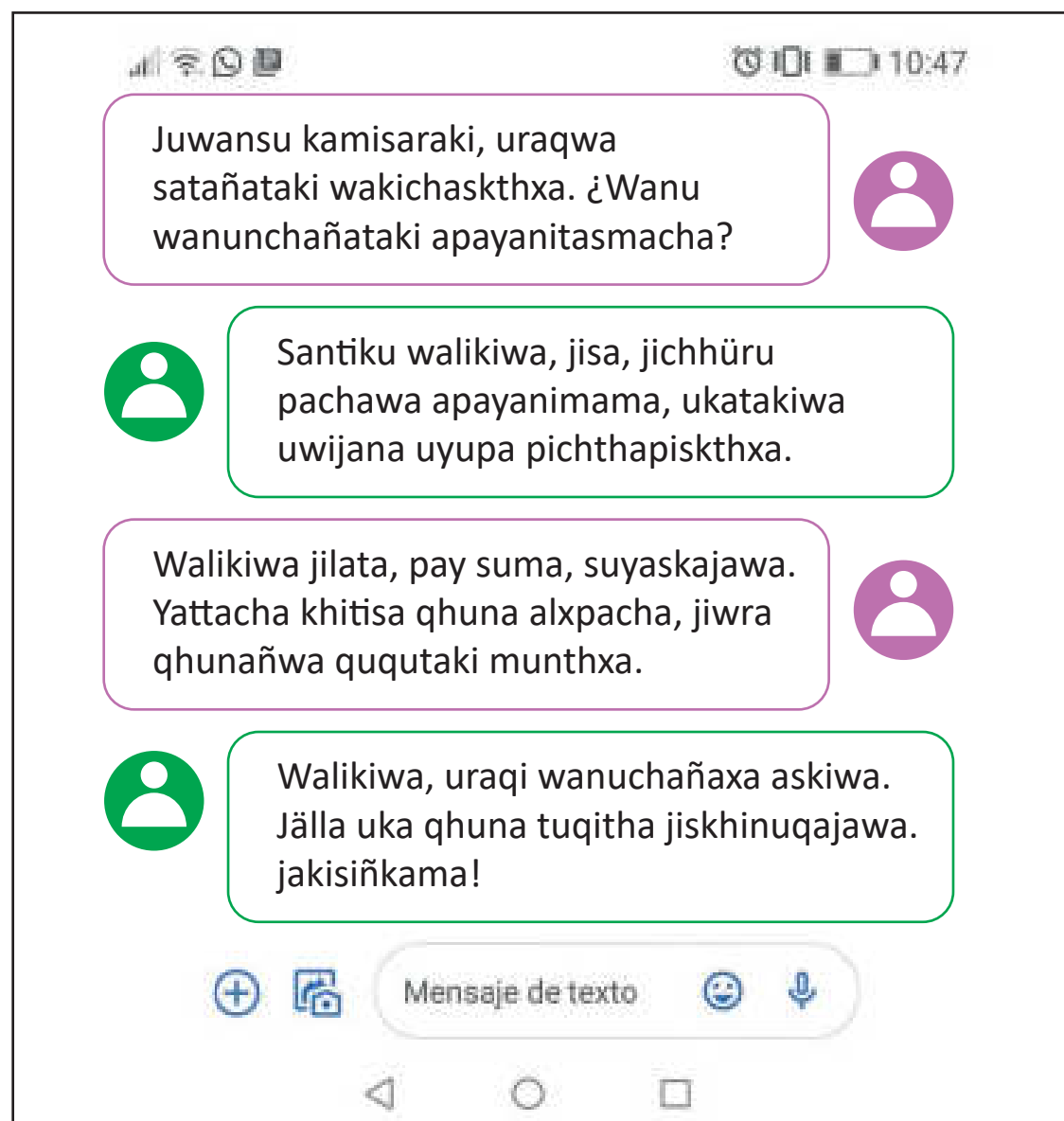

¿Maya silularampixa yatiyanaka apaysnati ukhamasa anchhichpacha aruskipsnati?



2. Arsuwimpi jaysma

- ¿Kuna tuqithsa Juwansumpi Santiku jilatampixa aruskipapxpacha? ¿Kunatakisa Juwansuxa wanu muni? ¿Kamachisa wilamasimaxa yapu achuqañapataki? ¿Santiku jilataxa kuna achunaksa satpachani?

3. Sutinaka ullma, 365 jakhu laphita jamuqa lip'iqayasa chiqawjaru lip'xatayma. Ukatha sapa wakichataru qillqanakapa qillqasma.

	apilla								
	qhuna								

4. Qillqa phuqañchañataki arunaka qillqasma.

Tatajaxa satañataki akiri jathanakwa apixa



_____ ,



_____ ukhamasa



_____ yapuruxa.

sarapxarakixa, ukataki kullakajaxa machaqa



_____ wakichäsina

jiwra ququtaki qhunarakinixa.

5. Aka arunakampi  qhuna,  apilla uka yaqha aru jaljtayatanaka uñstayañaru anatañäni. Aru jaljtayatanakampi phuqachma.

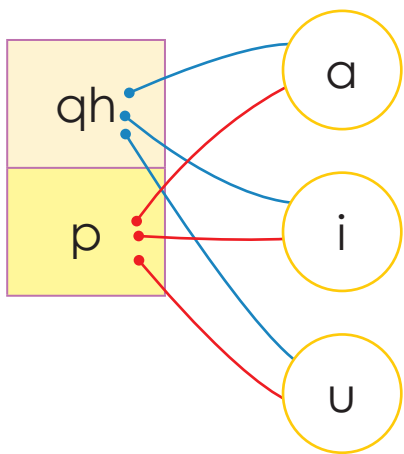

qha			aqh		
	pi				up

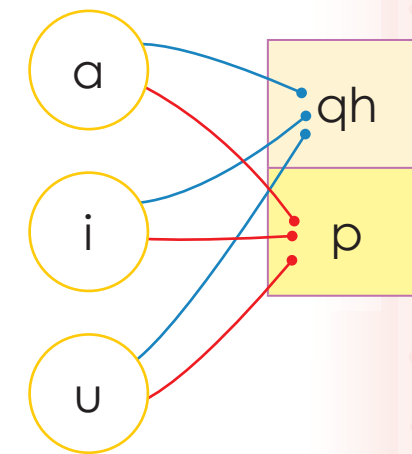

6. Jamuqanaka uñxatma, ukhama arunaka qillqisma.









7. Aru jaljtayata uñt'atamampi machaqa arunaka qillqma.

.....

.....

8. Jamuqanaka uñxatma, ukxaru sapaqatampi mä qillqa qillqasma.



1. _____
2. _____
3. _____
4. _____

Yatiqatasatha amuykipañäni

9. Kutt'ayma.

- ¿Kunjamsa machaqa arunaka ullaña qillqaña yatiqtansti?

Yatikipayasipxañäni

4 Laphi



Yatiqañataki wakichasipxañäni

1. Jamuqa uñxatma, ukhama jiskht'anaka kutt'ayma.

- ¿Kunasa jamuqana uñayasi?
- ¿Kunsa muña panqart'aski ukaxa saña munchituxa?
- ¿Kuna pachansa achunaka satapxsnasti?



Askipacha yatxatapxañäni

2. Wilamasimampi ukhamasa yatiqiri masinakamampi, kunathsa muña panqart'irixa yäqañasa, uka lumasatha aruskipma. Kamsaptamsa uka sixsma, ukhamasa qillqasma.

3. Yatirixa kamschitusa uka ullma.

Muña panqart'irixa sataña pachaxa nayräniti, taypiniti ukaya qhipänicha, ukwa jischituxa. Willka kuti phaxsinti panqart'chixa nayra satäniwa, llump'aca phaxsinti ukjaxa taypi satäniwa, sata qallta phaxsina ukjaraki qhipa sata maräniwa, uka yatiychistuxa.



4. Aski satañataki lumasanakatha aruskipañäni.

5. Janira aruskipkäsina, aski satañataki mä lumasa ajllma, ukhama sixsma.

- ¿Kuna tuqithasa lumasaxa?
- ¿Kamsañsa muni?
- ¿Achunakaxa kuna pachansa sataña jani ukachaxa kunjamasa sataña?

6. Jichhaxa, yatiqiri masinakamampi aruskipma.

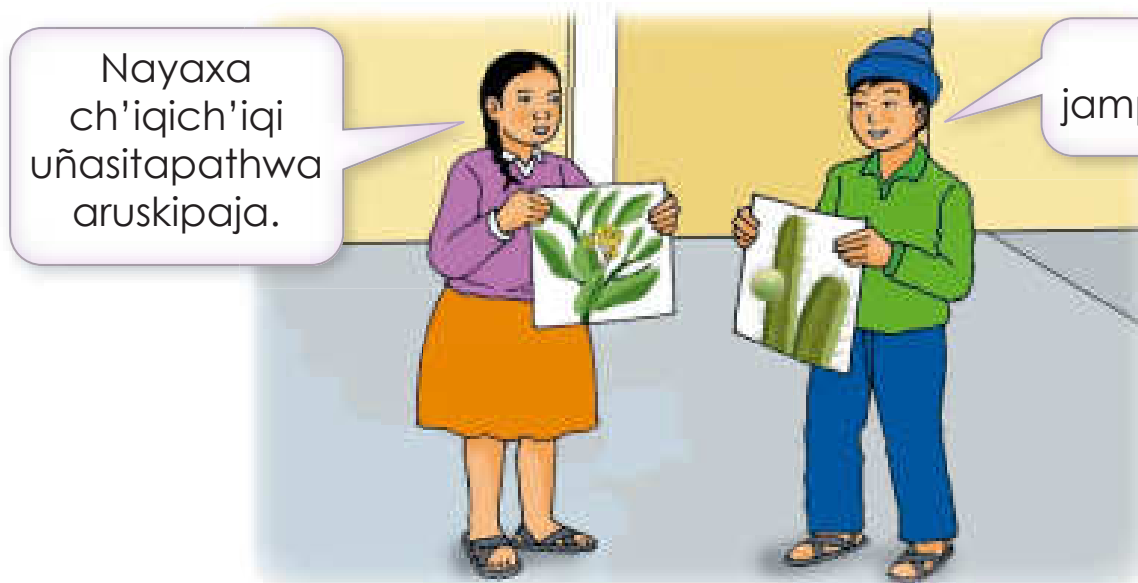

Nayaxa
ch'iqich'iqi
uñasitapathwa
aruskipaja.

Nayaxa,
jamp'atunakatha

Amtma:
Arsuñataki wakt'atama
suyañamawa.
Pacha churatakirawa arsuñamasa.
Arsuriru aski ist'añawa.
Yatiwisa qhanpacha arsuñawa.



7. Yatiqiri masinakamampi arsuwasinxaxa, luratama uñakipma. Ukatha luratanakama chimpuntma.

¿Lumasanaka ajllitatha aruskipawina jach'atha ukhamasa qhanti arsuwthxa?	Jisa	Janiwa
¿Yatiqiri masinakajaru askti ist'awthxa?		
¿Arsuñataki wakt'itu ukti suythxa?		

Yatiqatasatha amuykipapxañäni

8. Kutt'ayma.

9. ¿Maya aruskipawina arxatañatakixa kunanakasa yäqañasasti?



5 Laphi

Lurataja uñañcht'ayaja

Yatiqañataki wakichasipxañäni

¿Yapuchirinakaxa kunathsa jani chaniparu satawxapxi, ukxata qillqsuña munasmati?



¡Qillqsuñäni!

Askipacha yatxatapxañäni

- 1. Janira qillqasa jamuqanaka uñxatma, ukhama sapaqata lurawitha amuykipma. Qillqsuñamataki maya ajllma.**

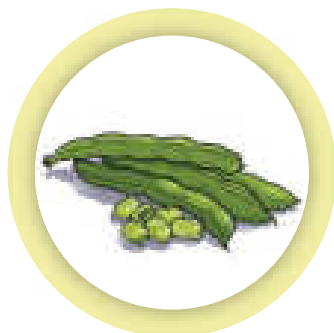

- 2. Qillqaña wakichma, ukhama lurawi ajllitama qillqasma.**

¿Kunsa qillqajasti?

¿Kunjamasa?

¿Kawkinkisa?

¿Kamachisa?

¿Kunjamasa uñjasthxa?

Aka amuysutawa amuyunakama wakichaña yanapätama.



3. Kunathsa yapuchirinakaxa jani chaniru satxapxi, uka qillqsuñamataki nayriri amuyunakampi qillqasma.

P'iqincha: _____

¿Kunsa qillqajasti?

¿Kunjamasa?

¿Kawkinkisa?

¿Kamachisa?

¿Kunjamsa uñjasthxa?

4. Yatiqiri masinakamataki jani ukachaxa mä wilamasimatakisa qillqsutama ullma, ukhama askichañataki iwxañaka katuqma.

Wilamasinakamaru ukhamasa yatiqiri masinakamarusa qillqsutama yatikipayma.



Yatiqatasatha amuykipañäni

5. Arsuwimpi jaysma. ¿Kunasa aka lurawina k'atampi munañjamanaxa? ¿Kunathsa?



Yatiqañataki wakichasipxañäni

1. P'iqincha ull't' ma ukatha jiskht'anaka kutt'ayma.

- ¿Qillaqataxa kuna tuqithsa yatiypachani? ¿Kunasa kamachpachani?

Askipacha yatxatapxañäni

2. Qillqata ch'ujuki ullma, ukathxa mä yatiqiri masimataki jani ukaxa wilamasimatakisa jach'a kunkatha ullma.

Qanchis aylluna ch'axluntata satañatha

Qanchis ayllunakanxa jathanakaxa wilamasjama, tayka, awki, ukhamasa jilatanakjama uñjatawa.

Achuqanaka kasta kasta imañatakiwa ch'axluntata satapxi: Tunqu sataña kikpa sukanwa jawasa, arwija, jiwra ukhamasa awina uchantapxixa.

Ukhamawa apthapiña pachataki kunaymana achunakaniwxapxixa. Ukhamarusa, taqinitakiwa utji, ukhamasa taqi kunataki, manq'añataki, imañataki, alxañataki, turkañataki kikipasa uywanakataki ukhamarusa luqtanakatakisa.



3. Yatiqiri masinakamampi aruskipma, ukhama jikht'anaka kutt'ayma:

- ¿Qillqataxa kawki aylluthsa jischitu? ¿Kunjamsa kunaymana achunaka imapxi?

4. Qanchis aylluna ch'axluntata satapxi uka sixsma, ukhamarusa ayllumana kunjamsa satapxi ukampi.

Qanchis Aylluna

Ayllujana

5. ¿Kunanakasa ayllumana ukhamasa Qanchis aylluna satawinakana mayjanakaxa, ukhamasa kunjama kikipanaksa jaktaxa? Sixsma, ukhama qillqasma.

Yatiqatasatha amuykipañäni

6. ¿Kunsa Qanchis aylluna satawipatha yatiqthana?



¡Anatapxañäni!

Aka qillq't'ata ullakipt'asa jamuqanaka llip'irayma, kamisati arsutäski ukhamarjama. Llip'katayañanakaxa 365 uka jakhuni laphinkarakiwa.

Kunaymana yanasiri Isaku

Isakuxa,
mä ch'utuquruwa mantäna;
uka ch'utuquxa uwija t'awratha luratänwa;
mä kustalaruwa mantäna.
kustalaxa sawusa luratänwa;
mä kajuna manqhanwa imantasina,
kajunaxa iwkaliptu lawatha luratänwa;
laranjaruwa mantäna,
laranjaxa puquränwa
ukatha Isakuxa qhispiwayiwa.

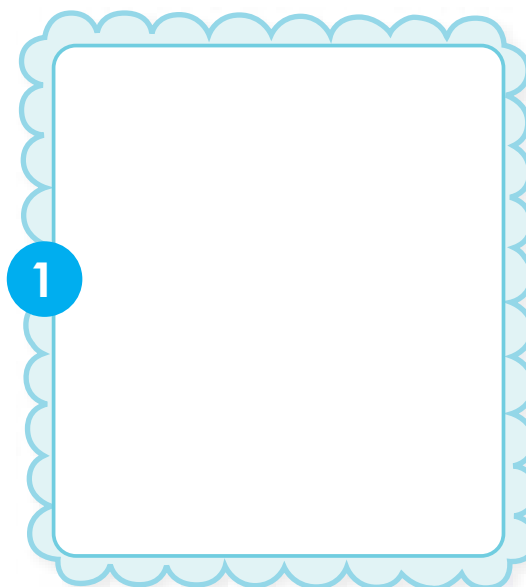

Masinakamaru akiri qillq't'atatha yatt'ayarakma jamuqanakampi chika arkayasa.

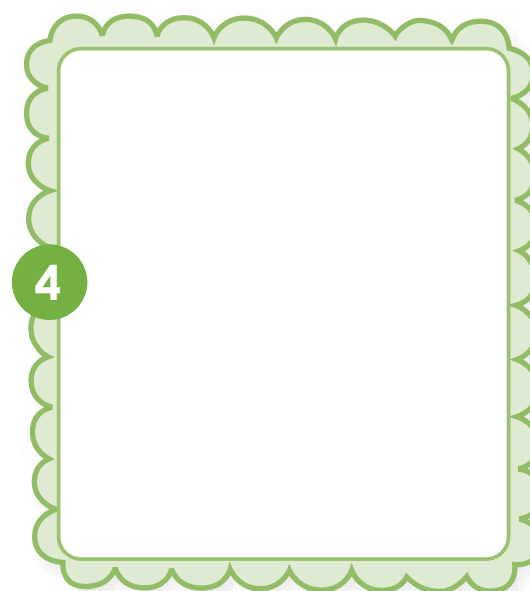
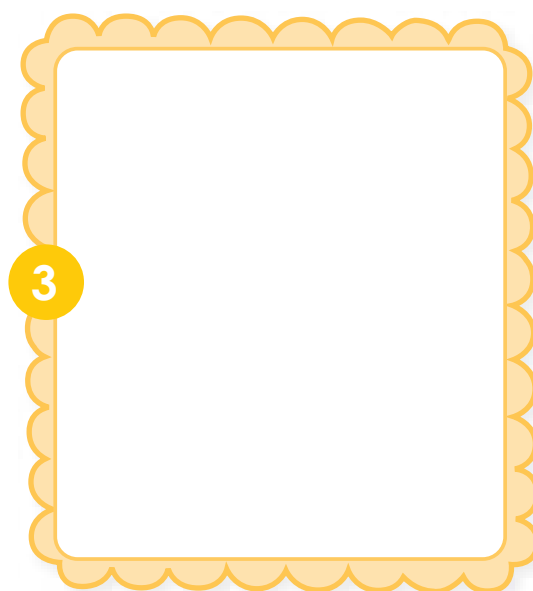
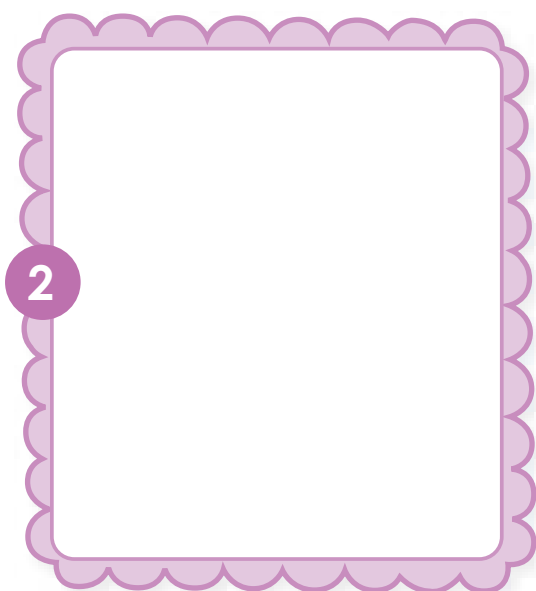



Taqinimpisa sumaki jakasipxañäni



¿Kunjamsa suma jakawi wilamasisa taypina ch'amañchasipxsnaxa?



Aski wakisiri utjirinaka

Suni tuqi ayllunakana jaqinakaxa, Pachamamampi ukhamarusa apunakampiwa sumaki utjasipxaraki. Jiwasa pacha utjawisanxa janiwa jaqi sapa ch'ullakikiti, taqiniwa munasiñampi yanapt'asipxi, uywasiñansa ukhama suma jakasiñataki. Jani ukaxa jichha qhipa maranakanxa uñjapthanwa wilamasinakupura juchhakthapiri, ayllunakansa jupanakkama uñkatasiri, Pachamamarusa janiwa yaqhipaxa yäqxapxarakisa.

Uñakipma ukatha kutt'ayma:

1. ¿Kunsa jaqinakaxa jamuqana lurasipki?
2. ¿Aka jamuqa uñakiptati? Aruskipma.



Ch'amt'añasa:

¿Kamachapsnasa wilamasinakasa suma jakasipxañapatakixa?

Lursuña: Wilamasinakaxa kunanakathsa juchhakipxi ukhama Pachamamarusa jani yäqxapxi uka yatiyañataki mä iwxa qillqa wakichapxañäni.

Kunathsa jiwasa taypina jani wali sarnaqawixa utji, ukxata yatxatapxañäni

1 Laphi



Yatiqañataki wakichasipxañäni



1. Ayllumana jani ukjaxa wilamasimana jiliri jaqimpi aruskipma, ukatha kunjamasa ayllumana suma utjasiñaxa, uka tuqitha jiskhtt'ma. Kunfi jiskht'ata uka sixsma.

Askipacha yatxatapxañäni

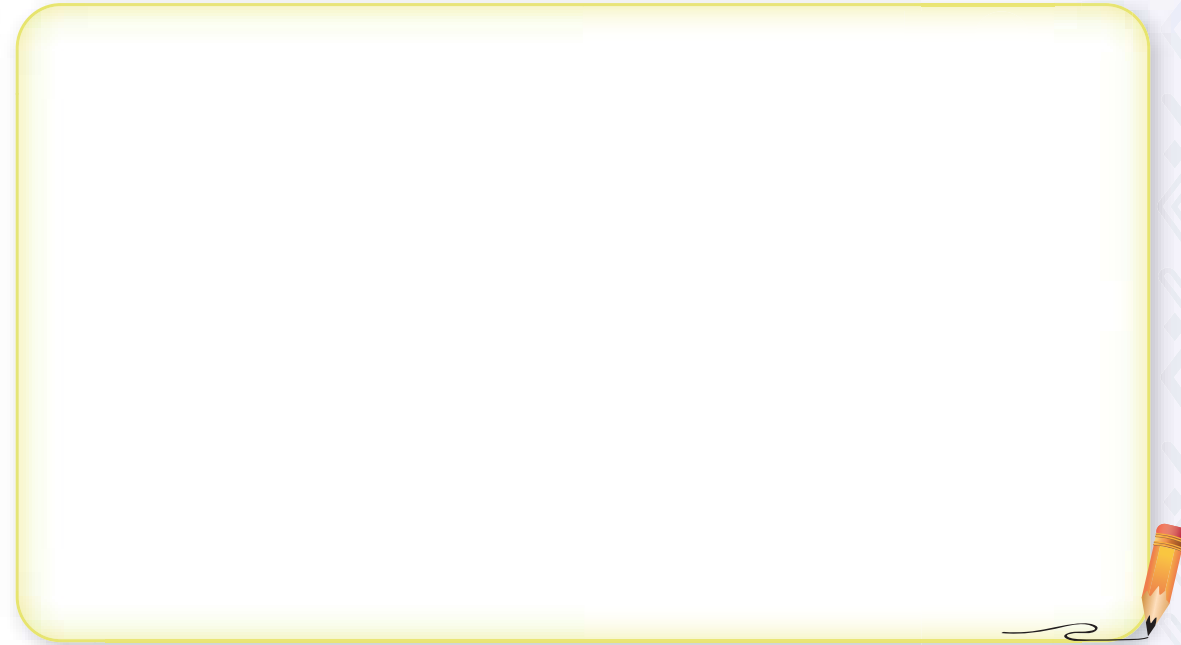
2. Qiilqata ullart'ma.



¿Kamachisa Pachamamampi suma utjasiñanxa?

Marsila  awichaxa Samira allchhiparu wali alwawa lurañanaka qallantañataki sartayäna. Kunjamfi taykapaxa apunakaru ukhamaraki  Pachamamarusa luqtaña yatichkäna, suma qamarañataki, ukhama amtayäna, kunjamsa maynita maynirusa suma tumpasiña, kikiparaki Pachamamarusa aski yäqañxata iwäna. Ukhata sarakinawa: "Jichhürunakanxa janqinakaxa janikiwa yäqasxapxiti, aruntasxapxisa, sapa mayni walinkañakwa thaqxapxi ukhamarusa wali qullqi chuymakipxarakiwa, q'añunaksa inaki williwachxapxi  Pachamamasa usutäxiwa kunaruki purkañäni" sasawa wali llakitha jikxatasina.

kunathsa jichhürunakana jaqipurasa
Pachamamarusa jani jäqxapxacha
uqxatha aruskipapxma.



3. Arst'asa ukatha qillqarakma, jiskht'anakaru kutt'ayañataki.

- ¿Kunsa awichaxa allchhiparu yatichäna? ¿Kunsa yatt'ayarakäina?
- ¿Kunathsa jaqinakaxa jani yanapt'asxapxi, jupanakkamasa kunathsa jisk'achasxapxacha?
- ¿Aski wakisiripachati taqinimpisa suma jakasiñaxa? ¿Kunathsa?

4. ¿Jani khithisa suma qamaña sarawirjama jakxaspha ukjaxa, kunasa kamachaspha? Jaysawimaru (X) chimpuntma.

Sarawinakasaxa chhaqtxasphawa

Jaqinakaxa k'uchisipxasphawa.

5. Qillqatana. ¿Kunathsa jani suma qamaña sarawirjama jakasitäxi?

Qillma, jani
ukaxa sixsma
jaysawima.



6. Wilamasinakamampi aruskipt'ama, kuna yaqha luräwinakasa suma qamañana chhaqtayaskpacha, ukxata.
7. Wilamasimaxa kunfi yatt'ayktama Pachamamampi chika suma jakasiña, uka tuqitha sixst'ma, ukhamarusa qillqt'arakma.



8. Yatiqiri masimaru wilamasimarusu qillqatamatha ukhamarusa sixst'atamasthsa yatt'ayma.

Yatiqatasatha amuykipapxañäni

9. Jiskht'anaka ullart'ma, ukhama kutt'ayawima samichma.

- ¿Ayllusana ukhamasa wilamasinakasa taypinsa suma jakasiña ch'amañchañasaxa wakisiti?

Jisa

Janiwa

- ¿Kunathsa?



2 Laphi

Maya amta jawari ull't'apxañäni ukatha qillqapxarakiñäni

Yatiqañataki wakichasipxañäni

1. Yatiqiri masinakamampi aruskipma:

¿Wakispachati Pachamamaru aski yäqañaxa?



Taqinisa Pachamamaru yäqapxañäni.

Askipacha yatxatapxañäni

2. Pachamamaru yuspajarañatakixa kunasa wakisi uka tuqitha ull't'apxañäni.

Samirampi Katimpixa kunjamsa awichaxa uywanakapampi aruskipäna, uka uñjiriwa sarapxäna.



Nayaxa kunti awichaxa uywanakaparu arxayki ukwa yatiña muntha.

Jisa, nayraqathxa kunathsa uywanakampi aruskipäña uka yatichapxamama.

Nayraqatxa kukampi t'inkampi aptasini.



¿Awicha uywanakampi aruskipäña yatichat'apxismati?



¡Akankxiwa, akankxiwa!

¡Jisa awichajawa! Kukapampi t'inkapampi apasinixa.

Nayraqatxa Pachamamaruwa yupaycht'ajaxa, ukxaruraki uywanaka jani saramukuñapataki, ukhamasa aski mirañapataki, taqi chuymampi mayt'asija.

Pachamamaxa kunati utjki q'alwa churchistuxa, ukathpi yäqañasa uñjañasasa, suma utjasiñataki.



Quli awicha, walikipuniwa yaticht'awapxistaxa pay suma.

3. Arumpiki jaysapxañäni.

- ¿Khitinakasa aruskipapxixa? ¿Kuna tuqithsa aruskipapxi?

4. Jaysawima chimpunthma: ¿Kunsa awichaxa wawanakaparu yatichi?

Uywanakampi aruskipaña

Uywanaka uñch'ukiña

5. Chiqapa suti chimpuntma.



awicha

achachila



t'inka

t'ika



uywanaka

uyunaka



kuka

waka



imilla

yuqalla



willka

sullka

6. Aru jaljanaka siqichma ukhama arunaka inuqma:

Uy na
ka wa

ka ku

chi a
wi

ka will

7. Arunaka ullawasina wakisiriparjama amuyunaka chiqanchma.

uywanaka

Julikuxa

walwa

mirayi

q'aywa

uwija

Samiraxa

chitaqallu

uywasi

8. Ch'axluta qillqanaka taypina arunaka jakma.

A	W	I	Cc	H	A	M	K	R	A
T	J	A	K	A	Ñ	T	U	Y	W
Q	U	Y	W	A	N	A	K	A	U
A	W	S	M	I	T	I	A	Q	M
T	I	J	A	K	A	S	I	Ñ	A
I	P	A	Q	H	P	A	W	Y	H
W	K	W	K	I	U	K	P	A	K
A	P	A	C	H	A	M	A	M	A

awicha
uywanaka
kuka
uma
Apu
Pachamama
jakasiña

9. Jamuqana sutipana qhipa sallapampi pä aru qillma.



.....
.....



.....
.....

10. Mä uñañcht'ayawitha sixst'ma ukatha wakichataru aruskipawinaka qillqma.

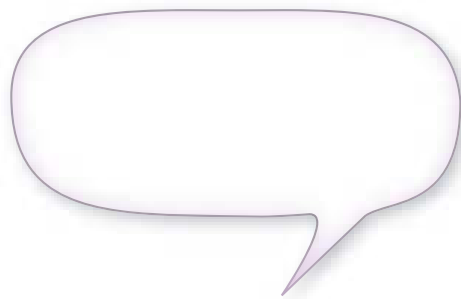

Yatiqatasatha amuykipapxañäni

11. Arumpiki jaysma.

- ¿Amta jawari ullañaxa jasakitati? ¿Kunjamsa ullakipt'awtaxa?
- Wilamasinakamampi suma jakañataki amtawi phuqañanaka qillqma.



3 Laphi

Nayra sarawitha ullapxañäni, qillqapxarakiñäni

Yatiqañataki wakichasipxañäni

¡Mä nayra sarawitha ullapxañäni, kikiya yatxaya wakiyañataki!



Askipacha yatxatapxañäni

1. Qillqata janira ull'kasa, jaysma.

¿Kuna yatyanaksa jakpachañäni?

¿Kunsa yatypachistani?

2. Ullapxañäni.

Awichana sarnaqawipa

Marsila awichaxa, kunjamsa nayra pachanakaxa jakasipxäna jupa wawakana, ukatha yatiyäna.

Awicha: Kunapachatixa wawäkayätha uka pachaxa chupika ch'ankhampiwa ch'iqä ampararu chint'apxitäna.

Wawa: Nayasa ukanirakiyäthwa.

Awicha: ¡Walisä! Ukathxa amparampi arunt'asiña, jayankapxchi ukaxa sumpirumpisa, jani ukachaxa ampara luqt'asisasa aruntasiña, ukhamanakwa yatichapxarakitäna. Ukathxa Pachamamarusa munasiña, q'añu t'unanaksa jani jaqtaña, ukanaka yatiqawayätha.

Wawa: Jisa, Jichhürunakanxa q'añunakaxa ancha jaqutapuniwa willisiki.

Awicha: Ukaxa jani waliwa, ukathpi yapusa, uywa uywachañasa aynachxixa.

3. Qillqata ullawasina jaysma:

- ¿Qillqataxa kunathsa yatiychistu? ¿Khitisa sarnaqawipa yatiyi?
- ¿Uka ullakipawithxa kunsá yatiqawthana?

¡Amuyunaka
ullt'apxañäni!



4. Akiri wakichatana arunaka ullma ukatha amuyunaka chiqachañataki tupayma.

Marsila awichaxa

Wawanakaruxa

Q'añunakaxa

Pachamamaru
usuntayxi.

suma jakaña tuqitha yatiyasi.

chupika ch'anqhampiwa ch'iqä
ampararu chint'apxritayna.

5. Uka chiqachata amuyunaka qillqasma.

6. Jamuqanakampi qillqanaka turkakipäsina amuyunaka qhanstayma.

a ■ i ▲ u +

■	■	■	■									▲	■			+	■						
P		c	h		m		m		m	p			c	h		k			s		m		
+				■		▲		■		■													▲
	t	h	j		s		p	x		ñ		n											

Jichhaxa, amuyunaka qillqt'arakma.

- -----
- -----
- -----
- -----
- -----

7. 365 jakhuni laphita llip'iyañanaka jikisina wakisitaparjama llip'katayma, ukatha aru jaljanakampi sutinakaparu phuqachma.

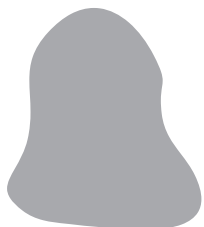

a__cha



ay__



ja__



phu__



kun__ri



pa__



pa__wa__



su__

8. Qillqata uñ'tata arunakampi phuqachma.

Marsila



_____xa, nayra sarnaqawipatha yatistu

_____, suma utjasiñataki.



Yatiqatasatha amuykipapxañäni

9. Jaysma.

- Wilamasinakasaxa kunaymana sarnaqawinakathwa suma jakasiñataki yatiychistu.
- ¿Kunsa uka sarnaqawinakatha yatiqapxthana?
- Wilamasinakamampi aruskipma kunanakasa aynacht'ayxi suma jakañxa ukxatha aruskipäsina qillqma.



4 Laphi

Yatikipayasipxañäni

Yatiquañataki wakichasipxañäni

1. Jamuqa uñxatasa jiskht'anakaru jaysma.

- ¿Kunampisa samkasixa?
- ¿Kunsa luraski?
- ¿Kamsañsa muni uka samkaxa?



Askipacha yatxatapxañäni

2. Wilamasimampi jani ukjaxa yatiqiri masinakamampi yaqha samkanakana yatiyawipatha aruskipma. Uka yatiyawitha sixst'ma, ukhamarusa qillqt'arakismawa.



3. Kunfi yatirixa siskana uka tuqitha ullt'ma:



Kunapachatixa samkamana qullu lumaru makhataskta ukjaxa, kunaxaya amtasksta lurañataki ukasa khust'arapitamwa ukwa samkamaxa yatiyasi.



4. Nayra sarawinakana jaqinakaxa kunjamsa Pachamamaru yäqana uka tuqitha kikipa yatxayapxma.

5. Janira kipka yatxaya qalltkasa wilamasinakampi jani ukjaxa yatiqiri masinakamampisa wakichasipxma, aka amtanakarjama.

Khitiruti kipka yatxaykäta uka arsuwinakapa yatiqma.

Kuna yänakaxaya kipka yatxayataki wakischini ukaxa wakichatañapawa.

Qhawqha pachaxaya jumataki wakt'ayatachi ukxa amtapunma.

Qhana arsmä.

Aski ist'ayasiñataki suma arumpi ukhama qhana arsmä.

6. Wilamasinakamampi, ukatha yatiqiri masinakamampisa kipka yatxayawi tuqitha aruskipapxma.

¿Kuna tuqi nayra sarawithsa kikipa yatxat'awapxtasti? ¿Khitirusa kikipa yatxatayawtaxa?



¿Kikipa yatxayañaxa munañjamati?



7. Wilamasinakamana, yatiqiri masinakamana kikipa yatxayawi tuqitha aruskipawinakapa ist'ma.
8. Wilamasinakamaru jani ukjaxa yatiqiri masinakamaru ist'aswasinxaxa, lurawinakama samichma.

Qhana arsuwaytha.

Mayninaka aski
ist'apxañapataki suma
qhana arumpiwa
arsuwaythxa.

Ajllitha lurawija
khust'ayawtha.

Yatiqatasatha amuykipapxañäni

9. Arst'asisa jaysma.

- ¿Kunjamsa uka yatxaya ukanxa jiqhtasiwtaxa? ¿kikipa yatxayañaxa khusawaraptamti? ¿Kunathsa?
- ¿Kuna yaqha tuqinakathsa kikipa yatxaya lurasiphaxa?

Lurataja uñt'ayaja

5 Laphi



Yatiqañataki wakichasipxañäni

¿Wilamasinakamaru yatiqiri masinakamarusa, kunathsa jiwasa taypina suma jakasiñasa chhaqtxaki, uka uñt'ayañataki yatiyaña munasmati?



¡Mä iwxa qillqa qillqapxañäni!

Askipacha yatxatapxañäni

1. Janira iwxa qillqa qillqkasa akiri iwxañaka amtma:

Kuna urusa qillqtha ukaxa uchatañapawa

Khititakinisa iwxa qillqa qillqatamaxa.

Sutimani ukhamasa rixunt'atañapawa tukuyañatakixa

2. Qillqa wakichkipma.

¿Kunsa qillqañäni?	¿Kuna tuqithsa qillqañäni?	¿Khititakisa qillqañäni?

3. Jichhaxa mä iwxa qillqama qillqt'ma.

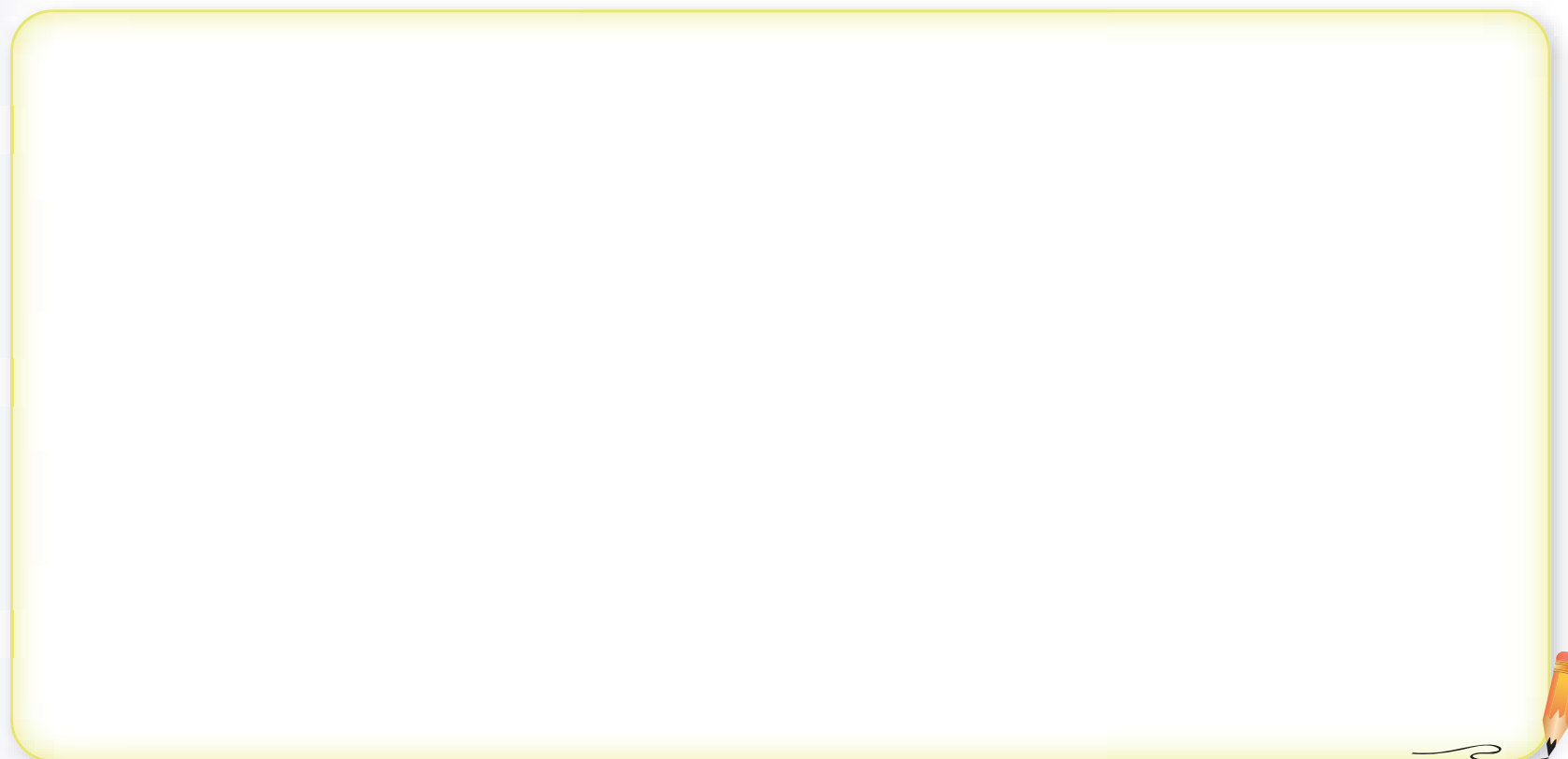

Amtasma, janiwa
jach'añapäkiti



4. Yatiqiri masinakamataki qillqatama ullt'ma, uka tuqitha aruskipawinaka ist'ma.

Yatiqatasatha amuykipapxañäni

5. Arst'asisa jaysma:

- ¿Iwxa qillqaxa kunanakathsa suma jakasiñasa chhaqtxaki uka uñt'ayañataki yatiyiti?



Kartama kawki chiqansa
taqini ullt'aspha ukawjaru
llip'katayma.

Shipibo-Konibo ayllunakana jakawinakapatha yatxatapxañäni

6 Laphi



Yatiqañataki wakichasipxañäni

1. Janira qillqata ullkasa, jaysma.

- ¿Kuna tuqithsa qillqataxa yatipacha? ¿Kunjamsa utjasixpacha Shipibo-Konibo uksäxa ayllunakanxa?

Askipacha yatxatapxañäni

2. Qillqata ullt'ma.

¿Shipibo-Konibo wilamasinakaxa kunjamapxisa?

Korin Bari sutini achichilaxa, khaya Canaán de Tipishca uka aylluna p'iqt'iripänawa, Ukayali jach'a jawira lakana chawllanaka katusa, quqaquqawjana, Pachamamarusa aski yäqasisawa jupaxa jakasirina.

Uka ch'umi suyuna utjasirinakaxa maynithsa maynikamaxa sumwa yäqasipxaraki. Uka qutu utjawiwjanxa takinitakiwa sapxarakiwa.

Nayra lurawinaksa Jilirinakatha sullkaruwa yatichasiskixa, ukhamatha sarawinakapa jani chhaqtañapataki.



2. Yatiqiri masinakamampi akiri jist'anakatha aruskipaxma:

- ¿Qillqataxa kawksaxa tuqithsa yatiyistu? ¿Kunjamsa utjasipxixa?

3. Ch'umi tuqina jakasiwinakapatha sixst'ma.

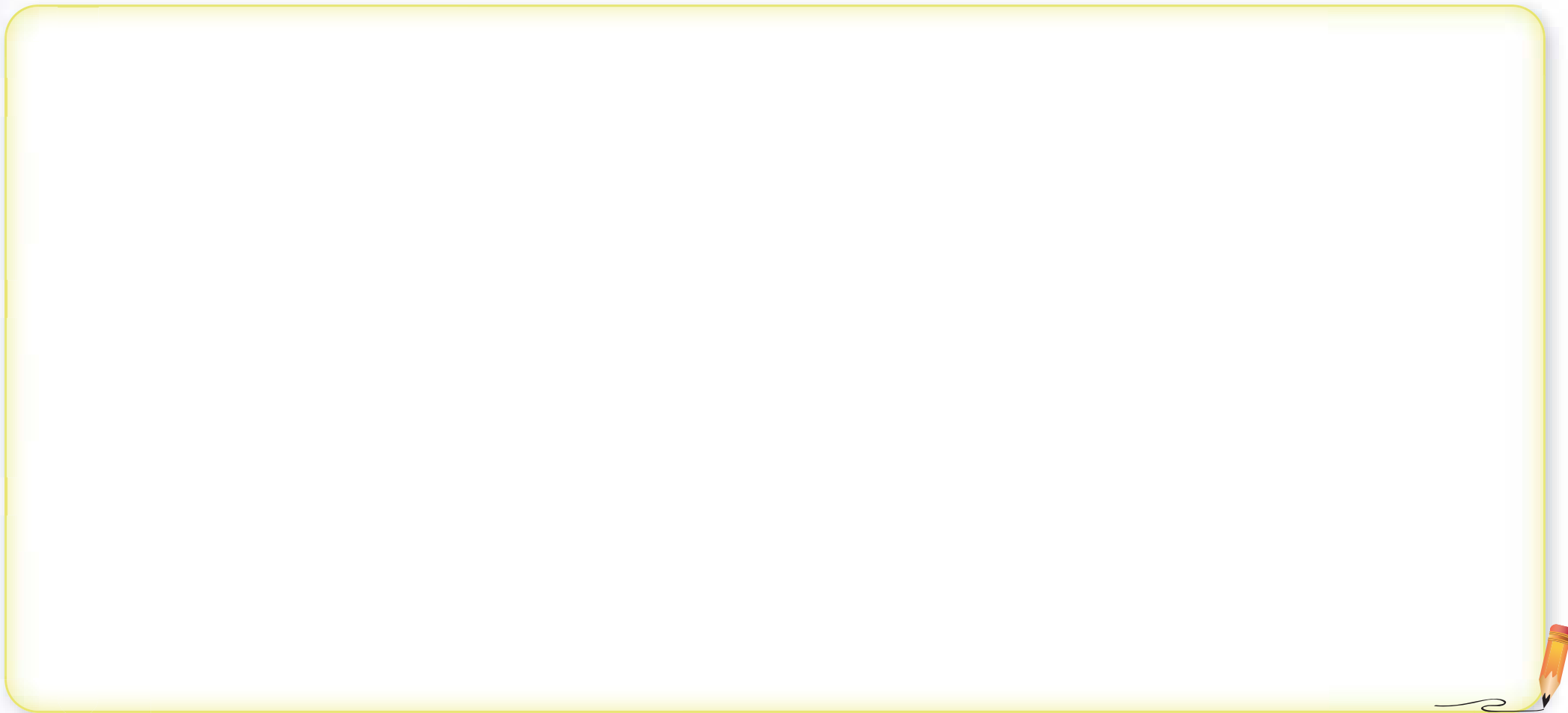

Askipacha yatxatapxañäni

4. Arst'asa jaysma.

- ¿Shipibo-Konibo utjasiwinakapatha kunsä amuytaxa? ¿Kunathsa?
- ¿Utjawimanxa quqanakaxa alirakiti? ¿Kunanakasa?

¿Kunathsa wilamasisa taypina jani suma jakawixa utjpacha?

16^{ri}

Yatiqawi



Aski wakisiri utjirinaka

Suni tuqi ayllunakana jaqinakaxa, Pachamamampi ukhamasa apunakampiwa suma utjasipxi. Aka qhipa maranakanxa wilamasinakasa taypinxa kunaymana juchhakiwinaka, ch'axwawinaka uñjapthana. Ukatha Pachamamaxa janiwa yäqatäxiti ukanakawa ch'ulljtayasi, qhipa mayja utjañana uka lurañanakampixa wilamasinakana suma jakasiñapsa jani waliru puriyarakisphawa.

Ch'amt'añasa:

¿Kamachsnasa wilamasisa taypina jani suma jakawi utjatapatha yatxatañatakixa?



Lursuña. Wilamasisa taypina jani suma jakawi utjatapatha mä amta jawari wakiyañäni.



1 Laphi

Suma jakaña tuqitha yatxatapxañäni

Yatiqañataki wakichasipxañäni

1. Wilamasinakamampi jani ukaxa yatiqiri masinakamampi aruskipma.



¿Kamachasphasa jani khitisa suma jakaña amuyumpi utjaskaspha ukjasti?

Askipacha yatxatapxañäni

2. Akiri qillqata ullt'ma.

Lapaqa phaxsina phuñchawipa

Jiwirinakaru amtaña phuñchawixa wilamasinakana aski mathapisiñawa, khitinakati yaqha pacharu sarxi jupanakaru amtañataki, ukhamatha wilamasinakana suma utjasipxañapataki. Uka uruxa kunaymana muxsa manq'anakani apxatanakampiwa jant'akupxixa, phuñchawixa samkañjamawa. Jilirinakasa kikiparaki wawanakasa taqiniwa jak'achasi, k'uchisiñaxa qallantiwa manq'anaka manq'añampi.

T'ant'a wawampi, k'ispiñampi, jallitampixa kunaymana uñtani utjañapapuniwa, wilamasisana luratasa, aylluna yaqha luratanakasa.

Jisnawa, jichha urunakanxa uka suma jakasiwixa armatjamakixiwa, kunasa alatakixiwa, aynisa chhaqtaxakiwa, wilamasinakasa wawanakaparu sapa sapa lurañarukiwa uñtayxi, ukhamaraki Pachamarusa jani yäqañaru. Yamasta umantañanakakiwa sinti utjawxi, ukanxa umata jaqinakasa juchharusa puripxarakiwa.



Suma jakasiña armasna ukjaxa kamachasphasa, uka tuqitha aruskipañäni.



3. Jiskht'aqwinakaru arsuwimpi jaysapxañäni.

- ¿Kunathsa jaqinakaxa lurañanakana janiki yanapt'asixpachasti? ¿Awichanakaxa kunsaxa iwaxapchistuxa?
- ¿Kunathsa aylluna suma jakasiña amuyumpi utjasiñaxa wakisi?

4. Amuyu qillqanaka ullt'ma, ukatha wakisiri jamuqampi chikthapiyima.



Kuna urusa qillqtha ukaxa uchatäñapawa

Manq'añanakasa wakichañaxa
amayunakaru amtañatakiwa.

5. Kutt'ayma. ¿Jaqinakana waxt'asiña chhaqtixaspha ukjaxa nayra sarawisaxa janiti utjixaspha, ukhamti amuyusma? ¿Kunathsa?

6. Kunanakampisa kamachaspha jani suma jakaña amuyumpi utjasipksna ukjaxa, uka tuqitha wilamasimampi jani ukjaxa yatiqiri masinakamampi aruskipma, ukhamarusa kamachapsnasa wasitatha kuttayañataki.

7. Wilamasimaxa kunti jisktama, uka tuqitha sixsma, kikipasa qillqasma.

Kamachasphasa	Kunasa lurañäspha

6. Yatiqiri masinakamampi jani ukachaxa wilamasimampisa qillqatama ukhamarusa sixsutama yatikipayma.

Yatiqatasatha amuykipapxañäni

7. Jiskht'anaka ullma, ukatha kutt'ayawima (X) ukampi chimpuntma, ukxaru kutt'ayarakma.

- ¿Wilamasinakaxa jani suma jakaña amuyumpi utjaspaxaspha, ukhamasa jani Pachamamaru yäqapxaspha ukjaxa kamachasphasa, uka yatiñaxa wakisiriti?

Jisa

Janiwa

- ¿Kunathsa?

- ¿Kuna lurañanakasa wakisiphasti?

Amtanakasa ullt'apxañäni ukhama qillqsupxañäni

2 Laphi



Yatiqañataki wakichasipxañäni

1. Ayllunkiri markachirinakaxa janiwa suma jakasiña chhaqtañapa munapkiti ukathwa mathapisipxani.

¿Kunatakisa mathapisipxpachani?



¿Amtanakti uchapxpachäni?

Askipacha yatxatapxañäni

2. Akiri qillqata ullt'ma.

Amtanaka

1. Taqi wilamasinakawa aylluru qillqantayasipxi.
2. Sapa martisa uruwa, markachirinakaxa ayni lurawinakampi qallantapxani.
3. Lunisa uru ukhamasa wirnisa urunakaxa warminakaxa yatiqaña utanwa mathapisipxani, imilla wawanakaru yatiwinakapa yatichañataki.
4. Aylluna p'iqt'rampi markachirinakampixa aylluna muytapxarakiniwa.
5. Waynanakaraki arumanakawa muytapxarakini.

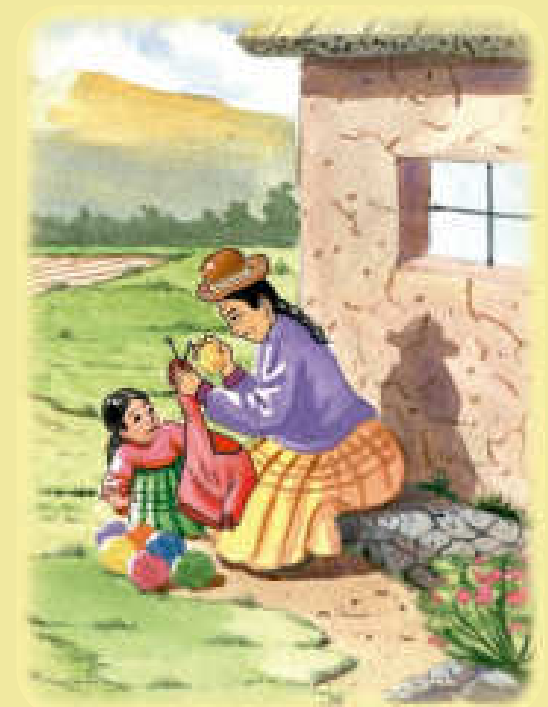

3. Qillqata ull'awasinxa, jiskht'anakaru kutt'ayma.

- ¿Khitinakasa yatiwinakapa yatichpachänisti? ¿Kawkinsa yatichapxpächani?
- ¿Markachirinakaxa qhawqha amtsa amtapxatayna? ¿Kunatakisa amtapxänasti?

4. Wakichatana arunaka ull'ma, ukatha qillqa k'ana taypina thaqäsina samichma.

warminaka-ayni- waynanaka-wilamasi-ayllu

w	a	y	n	a	n	a	k	a	p
a	t	i	w	n	a	s	a	l	l
w	w	a	r	m	i	n	a	k	a
y	i	l	w	a	y	n	y	s	y
n	w	k	t	u	r	i	n	a	l
w	i	l	a	m	a	s	i	m	l
j	r	a	q	a	t	w	m	t	u

5. Katjatha arunakampi amuyu qillqanaka phuqachma.

- _____xa, imilla wawanakaru p'itaña yatichapxi.
- _____lurawimpiwa qallantapxani.
- _____xa, arumanakawa muytapxani.

6. Aru jaljayatanaka askichma, ukhama arunaka qillqasma.



ta u



wu sa ri



ri ti p'i



ay llu

7. Akiri 363 jakhu laphinkiri llip'iyañampi llip'xatayma, ukatha mä qillqa qillqasma.



8. Jamuqanaka uñxatma, ukhama k'anata aru phuqachma.

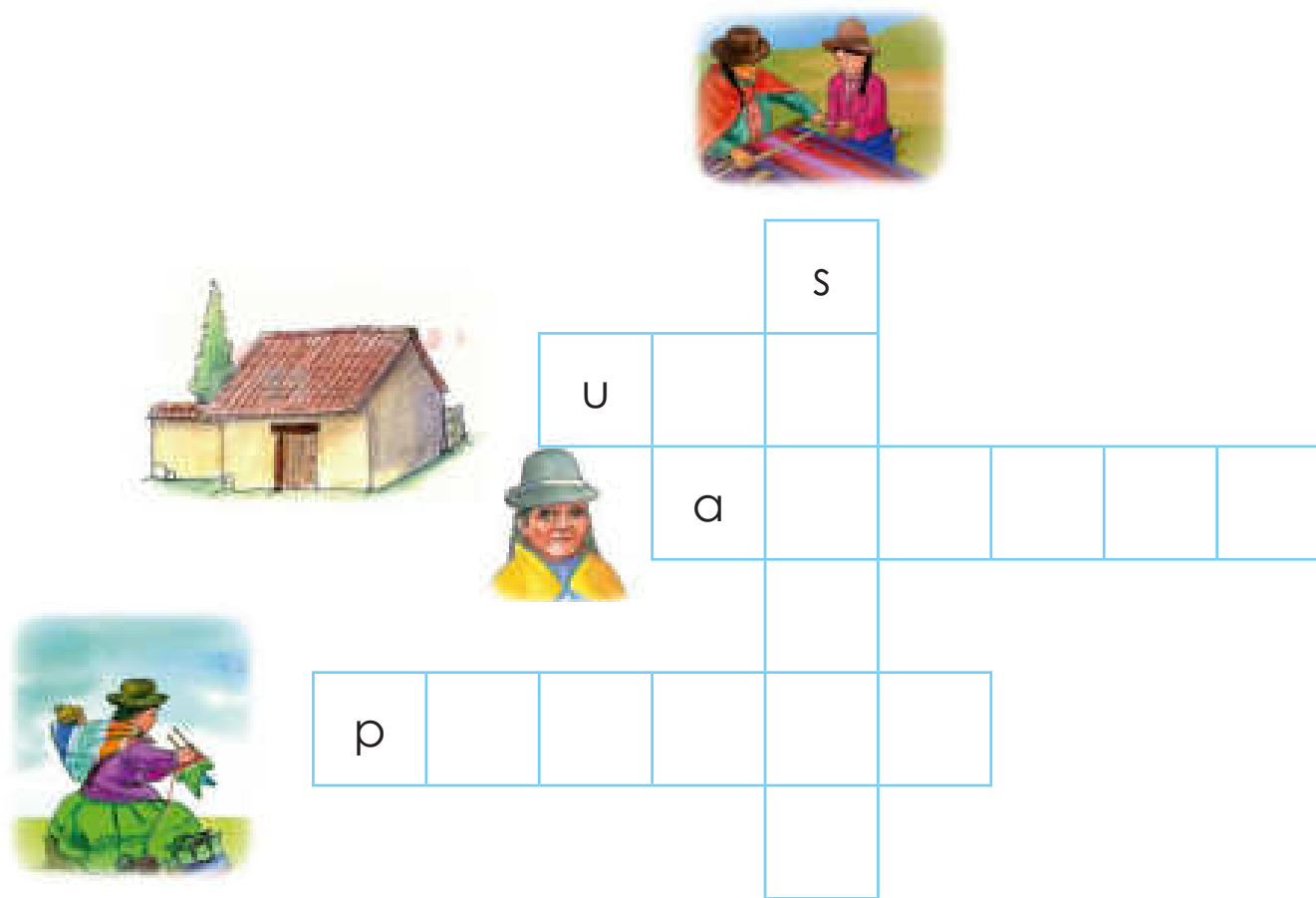

Yatiqatasatha amuykipapxañäni

9. Arsuwimpi jaysma.

- ¿Kunathsa amtanakaru puriñaxa wakisi? ¿Kuna yaqha lurawinakansa amtañaru purisisphasti?

Maya amta qillqa ullapxañäni ukhamasa qillqapxañäni

3 Laphi



Yatiqañataki wakichasipxañäni

1. Markachirinakaxa walja amtanakaruwa puripxi, jupanakaxa taqini markachirinaka phuqapxaspha ukwa munapxi.

¿Kunjamsa amtanaka phuqayapxañäni?



¿Taqiniti amta qillqana amtatanakaru rixintañapasti?

Askipacha yatxatapxañäni

2. Akiri qillqata ullt'ma.

Amta qillqa

Jichhüru, 29 lapaqa phaxsina, 2022 marana, Suq'a aylluna markachirinakaxa mathapisipxi, ukatha amtapxiwa.

Amtanaka:

1. Taqi wilamasinakawa aylluru qillqantayasipxani.
2. Sapa martisa uruwa, markachirinakaxa ayni lurawinakampi qallantapxani.
3. Lunisampi wirnisa urumpixa warminakaxa yatiqaña utanwa mathapisipxani, imilla wawanakaru yatiwinakapa yatichañataki.
4. Aylluna p'iqt'rampi markachirinakampixa aylluna muytapxarakiniwa.
5. Waynanakaraki arumanakawa wilañataki muytapxarakini.



.....
Rixintawi

.....
Rixintawi

.....
Rixintawi

3. Qillqata ullt'awasinxa, jiskht'anakaru kutt'ayma.

- ¿Kuna pankansa amtanakaxa qillqasisti?
- ¿Khitinakasa amtanakxaru rixintapxani?
¿Kunathsa amta qillqaxaru rixintapxani?



¡Ullt'apxañäni!

4. Jamuqaru kawkiri amuyu qillqati wakiski, uka ullt'ma, ukatha mä ✓ chimpuntma.

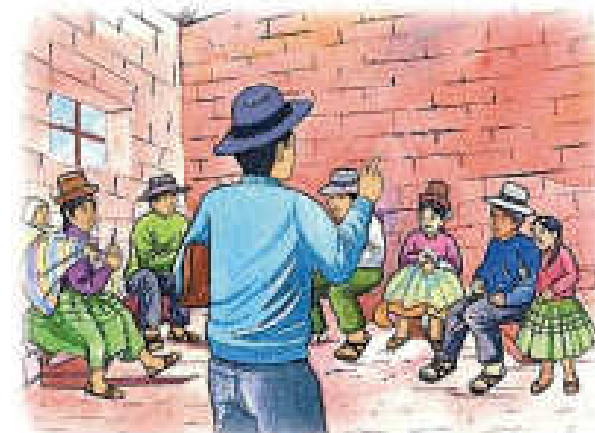

Awichajaxa luririwa.

Jusi yaxa yatiqaña uta uñji.

Markachirinakaxa anatapxi.

Warminakaxa p'itapxi.

Waynanakaxa arumawa muytapxi.

Markachirinakaxa mathapisipxi.

5. K'anata aru ullt'ma ukhama phuqachma.

Luraña qallta qala.

Arumanakawa muytapxi.

Imilla wawanakaru yatichapxi.

Martisa, wirnisa urunakawa mathapisipxi.

Apnaqaña qillqanakama wakischi ukaxa apnaqma.

6. K'anata arunakampi qillqanaka phuqachma.

_____ mpiwa, lurañanaka qallantapxäni.

_____ xa, martisa wirnisa urunakampiwa tantachasipxäni.

Imilla wawanakaxa _____ yatiqapxäni.

_____ arumanakawa muytapxäni.

7. Jamuqanaka uñxatma, ukhama sapa mayni jamuqataki mä amta qillqasma.



a.

ch.

chh.

Yatiqatasatha amuykipapxañäni

8. Jaysma.

- ¿Jumatakixa wakisiti taqi ukankirinaka amta qillqaru rixintañapasti?
- ¿Kunathsa?

Aruskipapxañäni

Yatiqañataki wakichasipxañäni

1. Jamuqa uñxatma, ukhama jiskht'anakaru kutt'ayma.

- ¿Kunathsa warmixa wawanaka isthapisinapa munisti?
- ¿Kamachisa wawanaka q'ara chichi sarnaqapxi ukjaxa?
- ¿Kunjamsa alaxpachaxa phiñasispha?

Askipacha yatxatapxañäni

2. Wilamasinakamampi yatiqiri masinakamapisa Pachamamaru jani phinasiñayañataki lurawinakxata aruskipapxma.
3. Sixst'ma, ukatha kunfi yatiyapktama uka qillqt'arakma.

4 Laphi



Wawanaka, jawirata mistupxma, ¡Isthapisipxma!
¡Alaxa pachawa phiñasini!

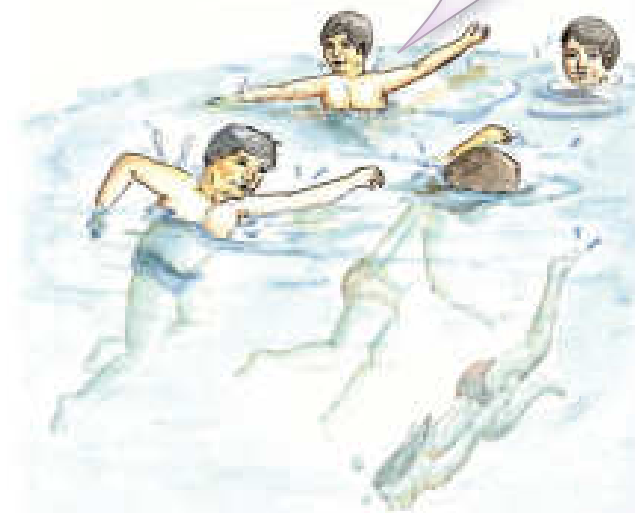

4. Yatiri kunti jiskchitu uka ullt'ma:



Kunapachati wawanakaxa q'ara chichi anatapxi jawiranakana ukjaxa, alaxpachaxa phinasisphawa chhijchisa q'alapuniwa yapunaksa k'utsuwasphaxa.

Kunarusa puripxsna jani suma qamaña saräwisarjana jakasitäxi ukjaxa, uka tuqitha mäya arusthapiwi wakiyapxañäni.



5. Janira arusthapkasa, paya qutucharu jaljtapxma, akiri tuqinakatha aruskipañataki: "Suma jakawixa ayllusa jaqinakana chuymapankiwa, janiwa armapxañäthanti".

6. Sapa qutuchaxa mä amuyumpiwa sayt'añapa.

7. Chimpuntma (X) ukampi. ¿Kawkiri amtanakarusa iyawsta?



Pachamamampi chika utjasiña saräwisarjama askiwa.

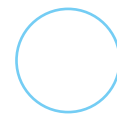

Sapasapa sarnaqañaxa khusawa, mayninakaxa qhipart'aystuwa.

8. Arusthapiwinkasaxa, amtapunma.

- Mayiri qutuxa suma jakaña tuqithwa arxatapxani.
- Payiri qutuxa sapa sapa sarnaqaña tuqithwa arxatarakini.
- Sapa qutuxa, arsuwinakapa wakichapxani.
- Amuyunakama suma wakiyma, ukhamasa qhana arsurakita.



9. Arusthapiwasinxaxa, Arxatatamarjama jisma.

Arusthapiwina	Jisa	Janiwa
¿Amtatarjamati ukhamasa qhanti arxattha?		
¿Pacha amtatarjamati arxatawaytha?		
¿Yatiqiri masinakajaruxa askti ist'awaythxa?		

Askipacha yatxatapxañäni

10. Arst'asisa jaysma.

- ¿Kunathsa wakisirixa mä arusthapiwina arxat'añaxa?



5 Laphi

Lurataja uñt'ayaja

Yatiqañataki wakichasipxañäni

¿Wilamasisa taypina jani suma jakawi utjatapa yatiyaña munasmati?



¡Mä amta jawari qillqapxañäni!

Askipacha yatxatapxañäni

1. Janira qillqasa, yatiqiri masinakamampi aruskipma, ukatha jaysma.

- ¿Kunathsa armasxaki suma jakaña sarawinaka ayllumanxa?
- ¿Kunarusa purt'asna suma qamaña sarawirjama jakasipxsna ukjaxa?

2. Jichhaxa, amta jarawi qillqa wakichkipma.

¿Khititakisa qillqañäni?	¿Kunjamasa amta jarawi qalltañäni?	¿Kuna jani walt'awithsa lurañäni?	¿Kunjamasa amta jarawi tukuyañäni ?	¿Khitinakampisa lurajasti?

3. Amta jarawi akiri wakichkipawirjama qillqantma.



4. Amta jawarima yatiqiri masinakamaru uñanchayma, jani ukaxa wilamasinakamarusa, ukhama arxatawinakapsa ist'arakma.

Yatiqatasatha amuykipapxañäni

5. Arst'asisa jaysma.

- ¿Kunarusä puripxsna ayllusana suma saräwirjama jani jakasxapsna ukjaxa, ukxata wakisiriti yatiyañaxa? ¿Kunathsa?



6 Laphi

Perú suyuna jach'a larama quta thiyana jakasipxatapatha uñt'apxañäni

Yatiqañataki wakichasipxañäni

1. Janira qillqata ullkasa, Jaysma.

- ¿Qillqataxa kuna tuqithäpachasa? ¿Kunjamsa Perú suyusana jach'a quta thiyana utjasipxpacha?

Askipacha yatxatapxañäni

2. Qillqata ullt'ma.

Jach'a larama quta thiyana jakasiña

Perú suyuna jach'a larama quta thiyana jakasirinakaxa jilapacha jach'a markanakanwa utjasipxi.

Jach'a patapata altusani utanakanwa, mä yaqhipaxa, k'ullu lawanakatha,istiratha, yaqhipaxa thuru kartunanakathsa wakt'ayasitakipxiwa, ukhamawa utjasipxixa.



Yaqhipaxa uma pisiphana, yapsa irpa umampikirakiwa lurapxi.

Yaqhipaxa uka jach'a larama qutanxa kunaymana chawllanakpinwa katupxaraki, ukaxa kuna yaqha aka uraqpacha markanakarusa purisphawa, aski manq'asiñataki, khusathsa khusapuniwa ukhamarusa jani tukuskayawa.



3. Yatiqiri masinakamampi aruskipma, akiri jiskht' anakatha.

- ¿Perú suyuna jach'a larama quta thiyana jakasiwinakapaxa kunjamaraptamsa?
¿Kunanaksa lurapxi?

4. Jach'a larama quta thiyana jakasirinakapana lurawipa tuqitha sixst'ma.



Yatiqatasatha amuykipapxañäni

5. Arst' asisa jaysma.

- ¿Jach'a larama quta thiyana utjasiwinakapaxa khusaraptanti? ¿Kunathsa?
- ¿Ayllumanxa kunjamsa yapu lurapxta?



¡Anatapxañäni!

367 jakhuni laphitha lip'iyañanaka thaqma, ukatha akiri wakichataru llip'irayma. Ukhamasa aru jaljanakampi phuqachma.

A	CH	CHH	CH'	
a	ch	chh	Ch'	
I	J	K	KH	
i	j	k	kh	
K'	L	LL	M	
k'	l	ll	m	
N	Ñ	P	PH	
n	ñ	p	ph	
P'	Q	QH	Q'	
p'	q	qh	q'	
R	S	T	TH	
r	s	t	th	
T'	U	W	X	Y
t'	u	w	x	y

Achakaja: abecedario, alfabeto

achikaña: pedir suplicar, rogar, implorar

ajanu: pagina, cara

akhama: ejemplo

ajlliña: seleccionar

amu: silencioso, callado

amuyaña: imaginar, representar idealmente una cosa

amuyu: oración

amuyu jaljayiri ch'aqa: punto seguido

amuyt'a: inteligencia, facultad de comprender, entendimiento

amta: memoria, facultad de recordar algo vivido o aprendido

amtawinaka: acuerdos

amsta: dirección hacia la subida en línea recta

arka: secuencia, continuación.

arsuta: frase

arunaka rixintaña: subrayar palabras

aruskipaña: hablar en diálogo, ponerse de acuerdo, avisarse

aruskipt'aña: departir, hablar, conversar

ch'aqa: punto(.)

chimpuntaña: empezar a marcar o señalar

chiqa yaya: objeto directo

ch'ixi: agrupación de estrellas

ch'ujtaña, amust'aña, amukt'aña: no hablar, guardar silencio

isk'a sich'i: guión(-)

irnaqaña: laborar, trabajar

iwx: recomendación

jach'a qillqa: mayúscula

jach'a sich'i: (_)

jaljayaña: dividir, clasificar

jamuqa: dibujo, foto

jaqichasiña: matrimonio

jaqiri: sujeto

jaqthapiri: conector

jasalla amuyu: oraciones simples

jawari: fabula, relato, cuento

jawarilla: historieta

jiskt'a, sikt'a chimpu: signo de interrogación(¿?)

jisk'a qillqa: minúscula

jiskt'awinakampi yatxataña:

entrevista

juyra: productos, plantas
comestibles.

jupha, jiwra: quinua

kamisa: ¿cómo?

kawki: ¿dónde?

kawkiri, kawkiyri, kawkchhapi: cuál
de ellos

kasta: clase, tipo

kawkiyri: ¿cuál?

katjawinaka: adivinanzas

khiti: ¿quién?

kikipa: lo mismo

kuna: ¿qué?

kuna lurañataki uka qillqata: libreto

kunawsa: ¿cuándo?

kutt'ayaña: responder, devolver

larusiña yatiyaw: anécdota

lup'iña: pensar, meditar, reflexionar

mathapiña: juntarse, reunirse,
aunarse

mayiña: solicitar, exigir, pedir

mayiña qillqata: memorial

muspha chimpu: signo de
admiración(¡!)

pä ch'aa: dos puntos(:)

pantachayaña: interrumpir

p'iqincha: título

phuqachaña: completar

qallta: inicio, introducción

qhananchaña: aclarar, explicar,
esclarecer

qhansuyata: resultado

qhawqha: cuanto'

qillqanaka qawayapa: silueta de
palabras

qillqaña chimpunaka: signos de
puntuación

qillqata panka: libro

qillqata t'aqanaka: párrafos

qillqiri: autor, escritor

qutuchaña: agrupar

rixña: rayar, hacer rayas

rixitani laphi: lámina

samichaña: colorear, pintar

sawuña, sayuña: tejer

sich'i: línea, trazo.

sikhiña: interrogar, preguntar

siqintaña: poner en fila

siri: glosa

sixsu: dibujo ilustración

sutilanti: pronombre
suti rixsuta: firma
tantachaña: agrupar
tupayaña: comparar
tupayaña arunaka: conectores
t'aqa: división, párrafo, repartimiento, separación
tukuyaña ch'aqa: punto final
uñtata: parecido
wamphi, alluxa, walja: mucho
wakichaña: alistar, preparar, organizar, disponer algo para un fin.
wakichaña: receta
wakiyaña: planificar
wakisiri: oportuno, útil, importante, necesario, indispensable.
wakt'ayaña: llegar al objetivo o punto, hacer alcanzar
warurt'aña: cantar
wich'illa: coma(,)
wich'illani ch'aqa: punto y coma(;)

uñancha: demostración, ejemplo
uñakipaña: mirar examinar un objeto por todos los lados.
uñakipawi qillqata: texto descriptivo
uñacht'ayiri qillqata: texto expositivo
uñjasa arsuwi: descripción
yatiyaña: avisar, hacer saber, declarar, anunciar, enterar, notificar, comunicar, transmitir, informar, divulgar, difundir, propagar.
yänaka: objetos, cosas
yatinaka jisk'aru apthapita: resúmen
yatiyanaka: noticia, información, cuento, relato
yatiyawwi: anuncio, aviso, noticia, información
yatiyawini laphi: afiche
yatiya qillqa: carta
yatxataña: averiguar, estudiar, investigar, indagar

CARTA DEMOCRÁTICA INTERAMERICANA

I La democracia y el sistema interamericano

Artículo 1

Los pueblos de América tienen derecho a la democracia y sus gobiernos la obligación de promoverla y defenderla. La democracia es esencial para el desarrollo social, político y económico de los pueblos de las Américas.

Artículo 2

El ejercicio efectivo de la democracia representativa es la base del estado de derecho y los regímenes constitucionales de los Estados Miembros de la Organización de los Estados Americanos. La democracia representativa se refuerza y profundiza con la participación permanente, ética y responsable de la ciudadanía en un marco de legalidad conforme al respectivo orden constitucional.

Artículo 3

Son elementos esenciales de la democracia representativa, entre otros, el respeto a los derechos humanos y las libertades fundamentales; el acceso al poder y su ejercicio con sujeción al estado de derecho; la celebración de elecciones periódicas, libres, justas y basadas en el sufragio universal y secreto como expresión de la soberanía del pueblo; el régimen plural de partidos y organizaciones políticas; y la separación e independencia de los poderes públicos.

Artículo 4

Son componentes fundamentales del ejercicio de la democracia la transparencia de las actividades gubernamentales, la probidad, la responsabilidad de los gobiernos en la gestión pública, el respeto por los derechos sociales y la libertad de expresión y de prensa. La subordinación constitucional de todas las instituciones del Estado a la autoridad civil legalmente constituida y el respeto al estado de derecho de todas las entidades y sectores de la sociedad son igualmente fundamentales para la democracia.

Artículo 5

El fortalecimiento de los partidos y de otras organizaciones políticas es prioritario para la democracia. Se deberá prestar atención especial a la problemática derivada de los altos costos de las campañas electorales y al establecimiento de un régimen equilibrado y transparente de financiación de sus actividades.

Artículo 6

La participación de la ciudadanía en las decisiones relativas a su propio desarrollo es un derecho y una responsabilidad. Es también una condición necesaria para el pleno y efectivo ejercicio de la democracia. Promover y fomentar diversas formas de participación fortalece la democracia.

II La democracia y los derechos humanos

Artículo 7

La democracia es indispensable para el ejercicio efectivo de las libertades fundamentales y los derechos humanos, en su carácter universal, indivisible e interdependiente, consagrados en las respectivas constituciones de los Estados y en los instrumentos interamericanos e internacionales de derechos humanos.

Artículo 8

Cualquier persona o grupo de personas que consideren que sus derechos humanos han sido violados pueden interponer denuncias o peticiones ante el sistema interamericano de promoción y protección de los derechos humanos conforme a los procedimientos establecidos en el mismo. Los Estados Miembros reafirman su intención de fortalecer el sistema interamericano de protección de los derechos humanos para la consolidación de la democracia en el Hemisferio.

Artículo 9

La eliminación de toda forma de discriminación, especialmente la discriminación de género, étnica y racial, y de las diversas formas de intolerancia, así como la promoción y protección de los derechos humanos de los pueblos indígenas y los migrantes y el respeto a la diversidad étnica, cultural y religiosa en las Américas, contribuyen al fortalecimiento de la democracia y la participación ciudadana.

Artículo 10

La promoción y el fortalecimiento de la democracia requieren el ejercicio pleno y eficaz de los derechos de los trabajadores y la aplicación de normas laborales básicas, tal como están consagradas en la Declaración de la Organización Internacional del Trabajo (OIT) relativa a los Principios y Derechos Fundamentales en el Trabajo y su Seguimiento, adoptada en 1998, así como en otras convenciones básicas afines de la OIT. La democracia se fortalece con el mejoramiento de las condiciones laborales y la calidad de vida de los trabajadores del Hemisferio.

III Democracia, desarrollo integral y combate a la pobreza

Artículo 11

La democracia y el desarrollo económico y social son interdependientes y se refuerzan mutuamente.

Artículo 12

La pobreza, el analfabetismo y los bajos niveles de desarrollo humano son factores que inciden negativamente en la consolidación de la democracia. Los Estados Miembros de la OEA se comprometen a adoptar y ejecutar todas las acciones necesarias para la creación de empleo productivo, la reducción de la pobreza y la erradicación de la pobreza extrema, teniendo en cuenta las diferentes realidades y condiciones económicas de los países del Hemisferio. Este compromiso común frente a los problemas del desarrollo y la pobreza también destaca la importancia de mantener los equilibrios macroeconómicos y el imperativo de fortalecer la cohesión social y la democracia.

Artículo 13

La promoción y observancia de los derechos económicos, sociales y culturales son consustanciales al desarrollo integral, al crecimiento económico con equidad y a la consolidación de la democracia en los Estados del Hemisferio.

Artículo 14

Los Estados Miembros acuerdan examinar periódicamente las acciones adoptadas y ejecutadas por la Organización encaminadas a fomentar el diálogo, la cooperación para el desarrollo integral y el combate a la pobreza en el Hemisferio, y tomar las medidas oportunas para promover estos objetivos.

Artículo 15

El ejercicio de la democracia facilita la preservación y el manejo adecuado del medio ambiente. Es esencial que los Estados del Hemisferio implementen políticas y estrategias de protección del medio ambiente, respetando los diversos tratados y convenciones, para lograr un desarrollo sostenible en beneficio de las futuras generaciones.

Artículo 16

La educación es clave para fortalecer las instituciones democráticas, promover el desarrollo del potencial humano y el alivio de la pobreza y fomentar un mayor entendimiento entre los pueblos. Para lograr estas metas, es esencial que una educación de calidad esté al alcance de todos, incluyendo a las niñas y las mujeres, los habitantes de las zonas rurales y las personas que pertenecen a las minorías.

IV Fortalecimiento y preservación de la institucionalidad democrática

Artículo 17

Cuando el gobierno de un Estado Miembro considere que está en riesgo su proceso político institucional democrático o su legítimo ejercicio del poder, podrá recurrir al Secretario General o al Consejo Permanente a fin de solicitar asistencia para el fortalecimiento y preservación de la institucionalidad democrática.

Artículo 18

Cuando en un Estado Miembro se produzcan situaciones que pudieran afectar el desarrollo del proceso político institucional democrático o el legítimo ejercicio del poder, el Secretario General o el Consejo Permanente podrá, con el consentimiento previo del gobierno afectado, disponer visitas y otras gestiones con la finalidad de hacer un análisis de la situación. El Secretario General elevará un informe al Consejo Permanente, y éste realizará una apreciación colectiva de la situación y, en caso necesario, podrá adoptar decisiones dirigidas a la preservación de la institucionalidad democrática y su fortalecimiento.

Artículo 19

Basado en los principios de la Carta de la OEA y con sujeción a sus normas, y en concordancia con la cláusula democrática contenida en la Declaración de la ciudad de Quebec, la ruptura del orden democrático o una alteración del orden constitucional que afecte gravemente el orden democrático en un Estado Miembro constituye, mientras persista, un obstáculo insuperable para la participación de su gobierno en las sesiones de la Asamblea General, de la Reunión de Consulta, de los Consejos de la Organización y de las conferencias especializadas, de las comisiones, grupos de trabajo y demás órganos de la Organización.

Artículo 20

En caso de que en un Estado Miembro se produzca una alteración del orden constitucional que afecte gravemente su orden democrático, cualquier Estado Miembro o el Secretario General podrá solicitar la convocatoria inmediata del Consejo Permanente para realizar una apreciación colectiva de la situación y adoptar las decisiones que estime conveniente. El Consejo Permanente, según la situación, podrá disponer la realización de las gestiones diplomáticas necesarias, incluidos los buenos oficios, para promover la normalización de la institucionalidad democrática. Si las gestiones diplomáticas resultaren infructuosas o si la urgencia del caso lo aconsejare, el Consejo Permanente convocará de inmediato un período extraordinario de sesiones de la Asamblea General para que ésta adopte las decisiones que estime apropiadas, incluyendo gestiones diplomáticas, conforme a la Carta de la Organización, el derecho internacional y las disposiciones de la presente Carta Democrática. Durante el proceso se realizarán las gestiones diplomáticas necesarias, incluidos los buenos oficios, para promover la normalización de la institucionalidad democrática.

Artículo 21

Cuando la Asamblea General, convocada a un período extraordinario de sesiones, constate que se ha producido la ruptura del orden democrático en un Estado Miembro y que las gestiones diplomáticas han sido infructuosas, conforme a la Carta de la OEA tomará la decisión de suspender a dicho Estado Miembro del ejercicio de su derecho de participación en la OEA con el voto afirmativo de los dos tercios de los Estados Miembros. La suspensión entrará en vigor de inmediato. El Estado Miembro que hubiera sido objeto de suspensión deberá continuar observando el cumplimiento de sus obligaciones como miembro de la Organización, en particular en materia de derechos humanos. Adoptada la decisión de suspender a un gobierno, la Organización mantendrá sus gestiones diplomáticas para el restablecimiento de la democracia en el Estado Miembro afectado.

Artículo 22

Una vez superada la situación que motivó la suspensión, cualquier Estado Miembro o el Secretario General podrá proponer a la Asamblea General el levantamiento de la suspensión. Esta decisión se adoptará por el voto de los dos tercios de los Estados Miembros, de acuerdo con la Carta de la OEA.

V La democracia y las misiones de observación electoral

Artículo 23

Los Estados Miembros son los responsables de organizar, llevar a cabo y garantizar procesos electorales libres y justos. Los Estados Miembros, en ejercicio de su soberanía, podrán solicitar a la OEA asesoramiento o asistencia para el fortalecimiento y desarrollo de sus instituciones y procesos electorales, incluido el envío de misiones preliminares para ese propósito.

Artículo 24

Las misiones de observación electoral se llevarán a cabo por solicitud del Estado Miembro interesado. Con tal finalidad, el gobierno de dicho Estado y el Secretario General celebrarán un convenio que determine el alcance y la cobertura de la misión de observación electoral de que se trate. El Estado Miembro deberá garantizar las condiciones de seguridad, libre acceso a la información y amplia cooperación con la misión de observación electoral. Las misiones de observación electoral se realizarán de conformidad con los principios y normas de la OEA. La Organización deberá asegurar la eficacia e independencia de estas misiones, para lo cual se las dotará de los recursos necesarios. Las mismas se realizarán de forma objetiva, imparcial y transparente, y con la capacidad técnica apropiada. Las misiones de observación electoral presentarán oportunamente al Consejo Permanente, a través de la Secretaría General, los informes sobre sus actividades.

Artículo 25

Las misiones de observación electoral deberán informar al Consejo Permanente, a través de la Secretaría General, si no existiesen las condiciones necesarias para la realización de elecciones libres y justas. La OEA podrá enviar, con el acuerdo del Estado interesado, misiones especiales a fin de contribuir a crear o mejorar dichas condiciones.

VI Promoción de la cultura democrática

Artículo 26

La OEA continuará desarrollando programas y actividades dirigidos a promover los principios y prácticas democráticas y fortalecer la cultura democrática en el Hemisferio, considerando que la democracia es un sistema de vida fundado en la libertad y el mejoramiento económico, social y cultural de los pueblos. La OEA mantendrá consultas y cooperación continua con los Estados Miembros, tomando en cuenta los aportes de organizaciones de la sociedad civil que trabajen en esos ámbitos.

Artículo 27

Los programas y actividades se dirigirán a promover la gobernabilidad, la buena gestión, los valores democráticos y el fortalecimiento de la institucionalidad política y de las organizaciones de la sociedad civil. Se prestará atención especial al desarrollo de programas y actividades para la educación de la niñez y la juventud como forma de asegurar la permanencia de los valores democráticos, incluidas la libertad y la justicia social.

Artículo 28

Los Estados promoverán la plena e igualitaria participación de la mujer en las estructuras políticas de sus respectivos países como elemento fundamental para la promoción y ejercicio de la cultura democrática.

















<u>a</u>	<u>a</u>	<u>a</u>	<u>a</u>	<u>a</u>	<u>i</u>
<u>i</u>	<u>i</u>	<u>i</u>	<u>i</u>	<u>u</u>	<u>u</u>
<u>u</u>	<u>u</u>	<u>u</u>	<u>j</u>	<u>j</u>	<u>j</u>
<u>k</u>	<u>k</u>	<u>k</u>	<u>!</u>	<u>!</u>	<u>!</u>

I	A	A	A	A	A
U	U	I	I	I	I
J	J	J	U	U	U
L	L	L	K	K	K

m

m

m

n

n

n

ñ

ñ

ñ

p

p

p

q

q

q

r

r

r

s

s

s

t

t

t

N

N

N

M

M

M

P

P

P

Ñ

Ñ

Ñ

R

R

R

Q

Q

Q

T

T

T

S

S

S

w

w

w

x

x

x

y

y

y

ll

ll

ll

k'

k'

k'

p'

p'

p'

q'

q'

q'

t'

t'

t'

X

X

X

W

W

W

LI

LI

LI

Y

Y

Y

P'

P'

P'

K'

K'

K'

T'

T'

T'

Q'

Q'

Q'

ch

ch

ch

kh

kh

kh

ph

ph

ph

qh

qh

qh

th

th

th

chh

chh

ch'

Ch'

Kh

Kh

Ch

Ch

Ch

Qh

Ph

Ph

Ph

Kh

Th

Th

Th

Qh

Qh

Ch'

Ch'

Chh

Chh

• Pág. 48



• Pág. 74



• Pág. 88



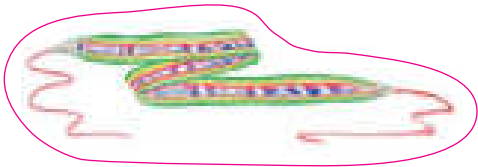
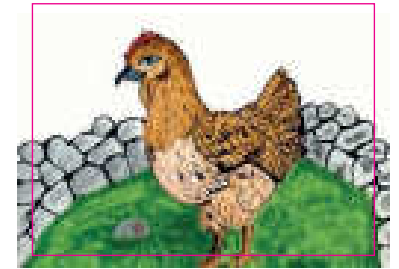
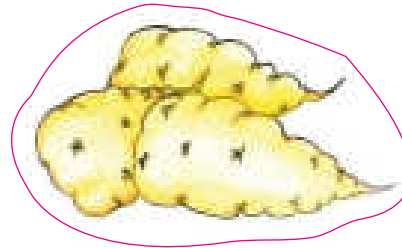
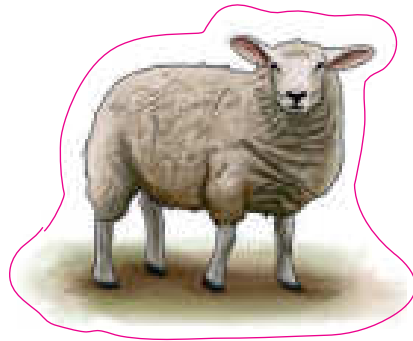
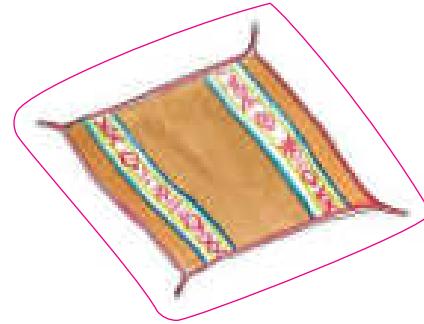
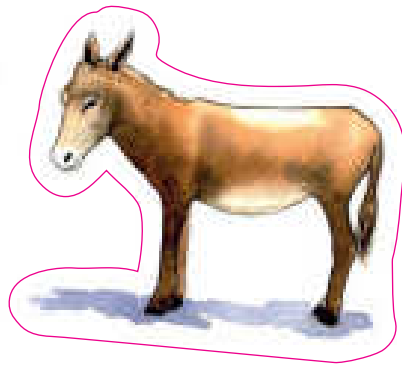
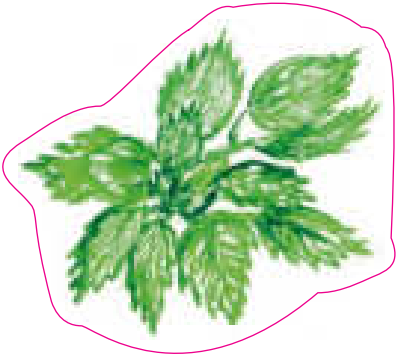

• Pág. 271



• Pág. 255

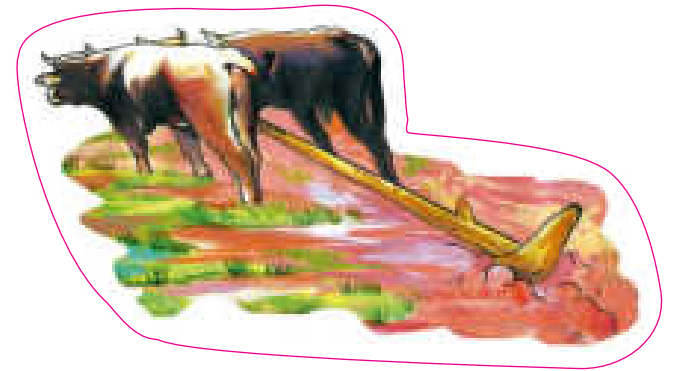

• Pág. 288

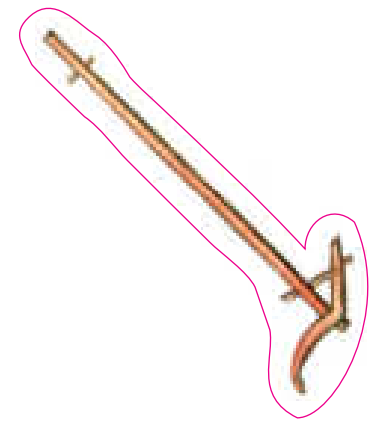
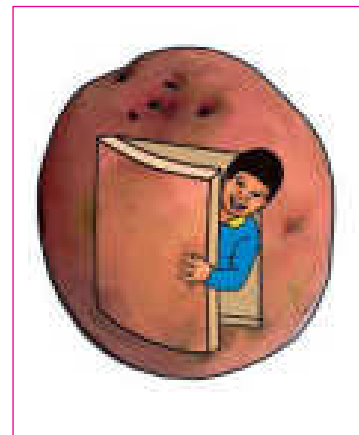

• Pág. 278



• Pág. 301

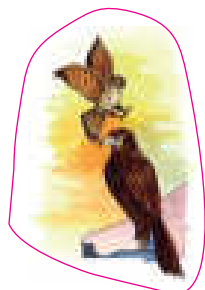
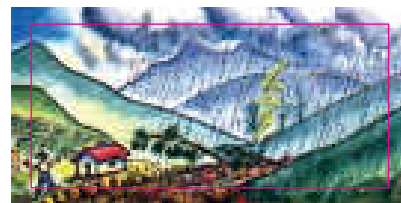
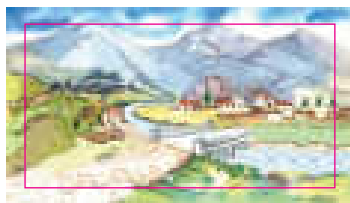

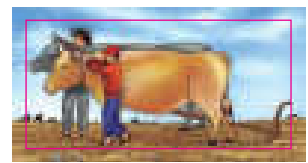
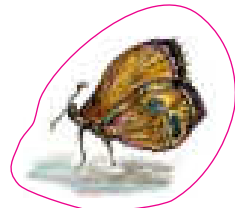
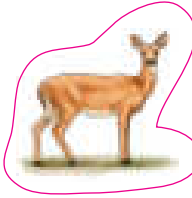
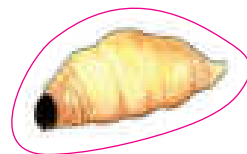
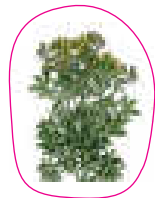
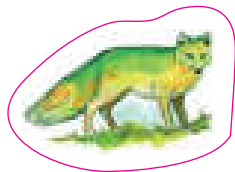
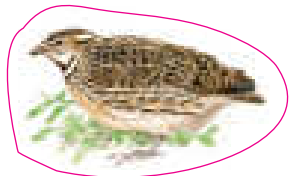
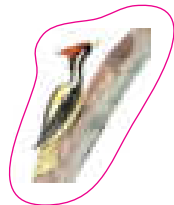
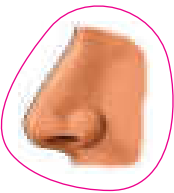
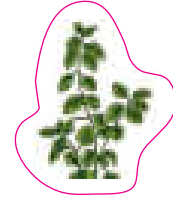
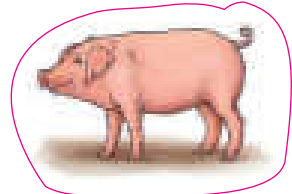
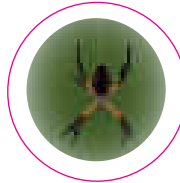
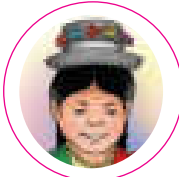
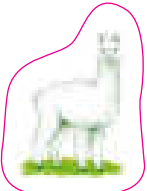



muña



atapallu



misik'u

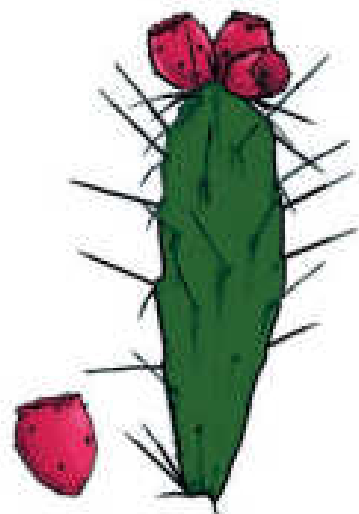

ayrampu

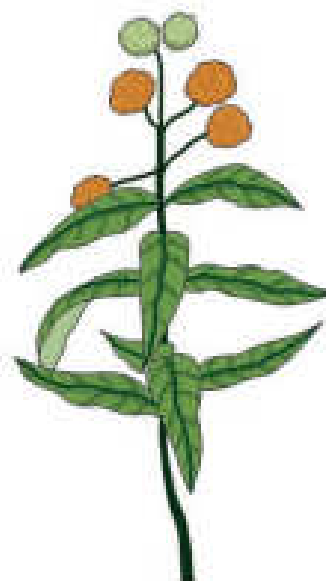

matiku



chhijchhipa



MISIK'U



ATAPALLU



MUÑA



CHHIJCHHIPA

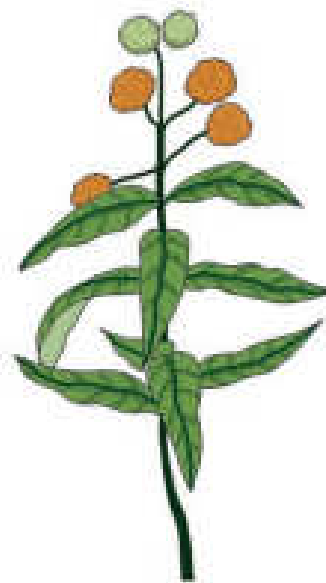

MATIKU

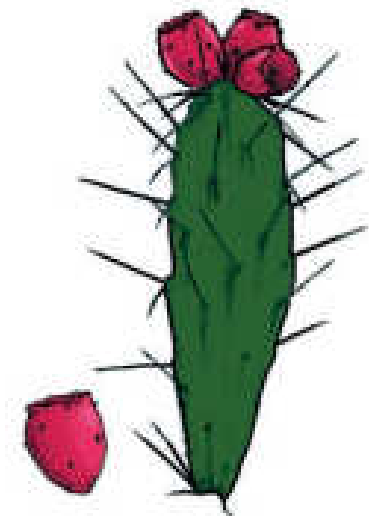

AYRAMPU



ch'uqi



apilla



isañu

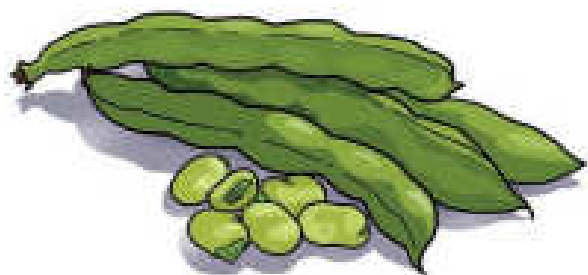

jawasa



siwara



tawri

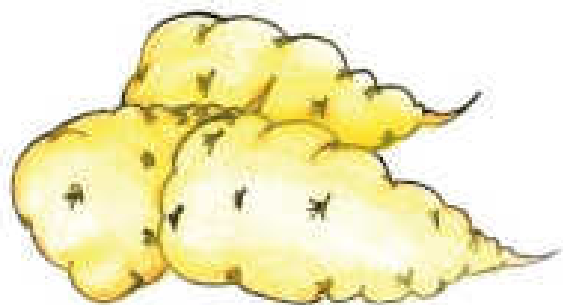

ISAÑU



APILLA



CH'UQI



TAWRI



SIWARA

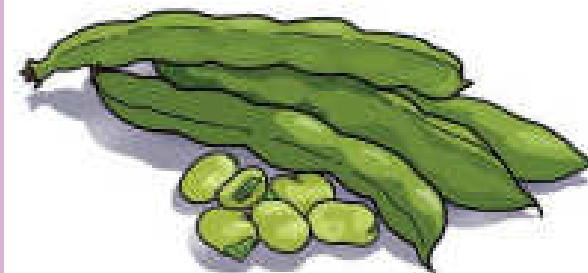

JAWASA



ch'uñu



kaya



kuka



isañu



thayacha



thutha



KUKA



KAYA



CH'UÑU



THUTHA



THAYACHA



ISAÑU



awicha



ch'ullu

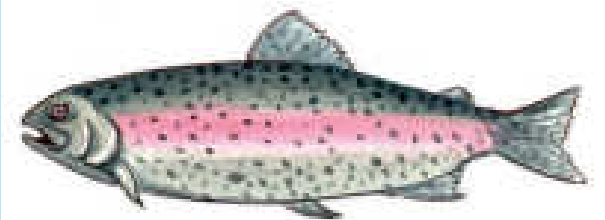

challwa

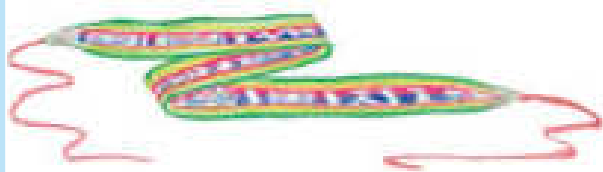

wak'a



q'urawa



phullu

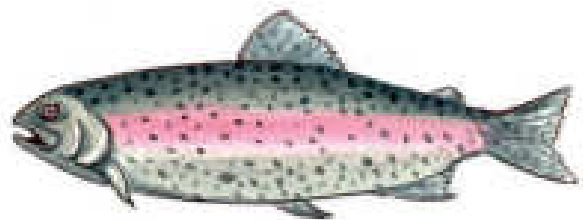

CHALLWA



CH'ULLU



AWICHA



PHULLU



Q'URAWA



WAK'A



jichhu



phala



chhiwchhi

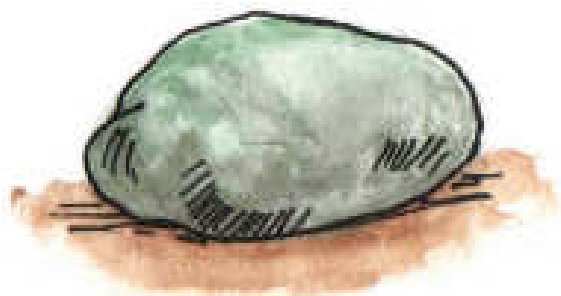

qala



piku

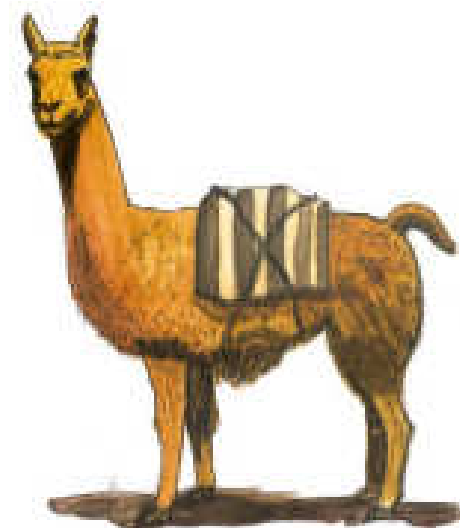

qawra

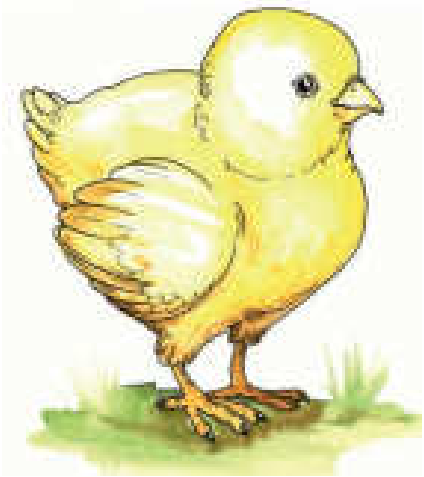

CHHIWCHHI

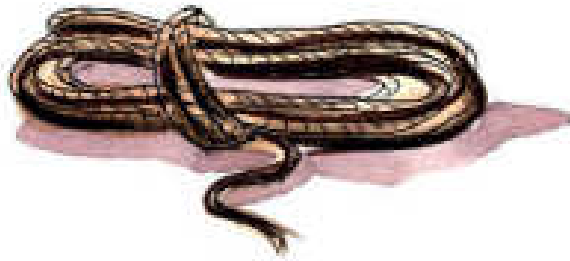

PHALA



JICHHU

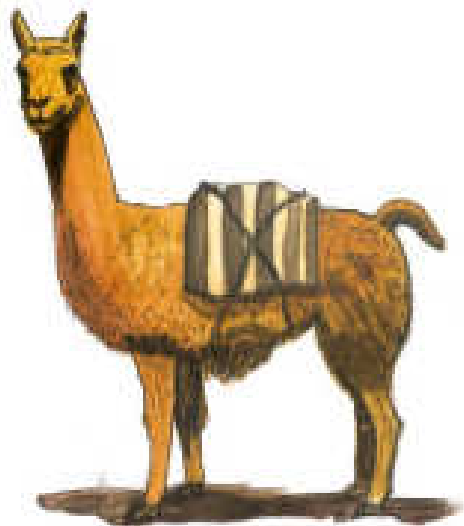

QAWRA



PIKU

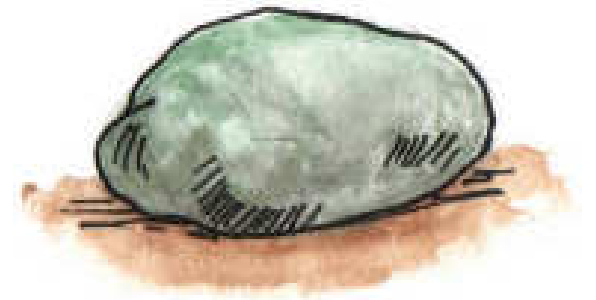

QALA



p'isaqa



t'awra



thaxa

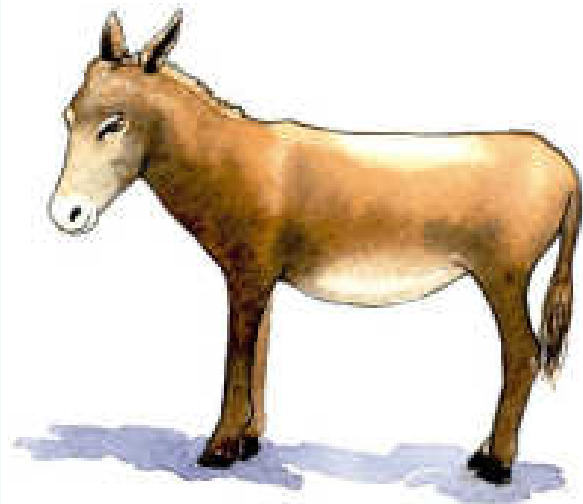

asnu



khullu



nina



THAXA



T'AWRA

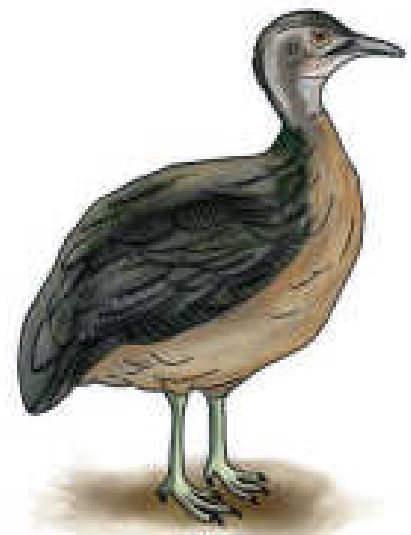

P'ISAQA



NINA



KHULLU

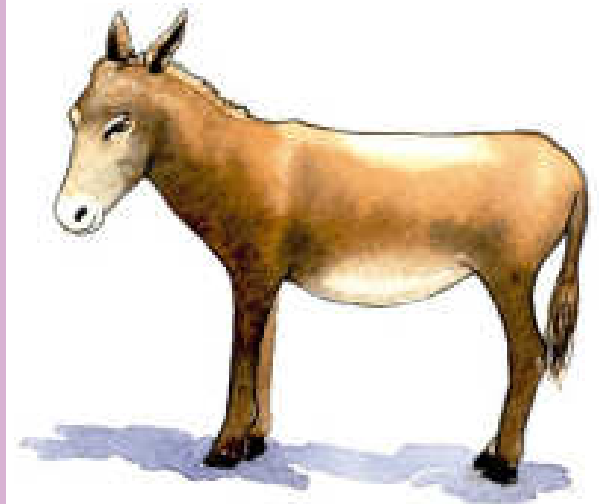

ASNU



yunta

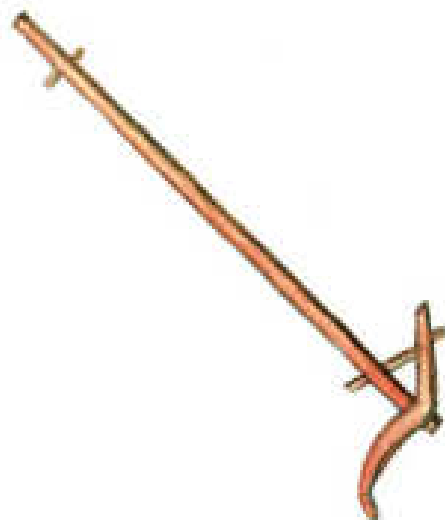

arma



lluku



apilla



qhuna



panqara



LLUKU

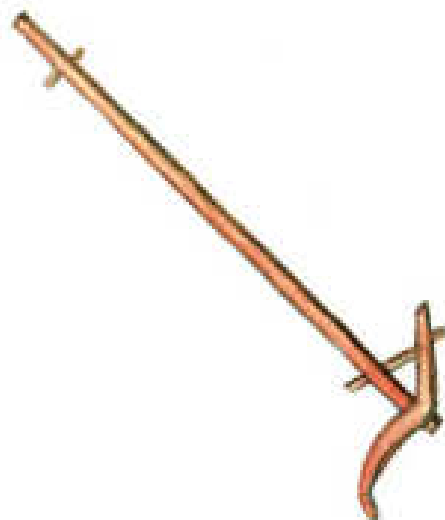

ARMA



YUNTA



PANQARA



QHUNA



APILLA



uywa



ayllu



warmi



t'inka



wilka



uta



WARMI



AYLLU



UYWA



UTA



WILLKA



T'INKA



P'ITAÑA



p'itaña



APTHAPIÑA



apthapiña



UTACHAÑA



utachaña

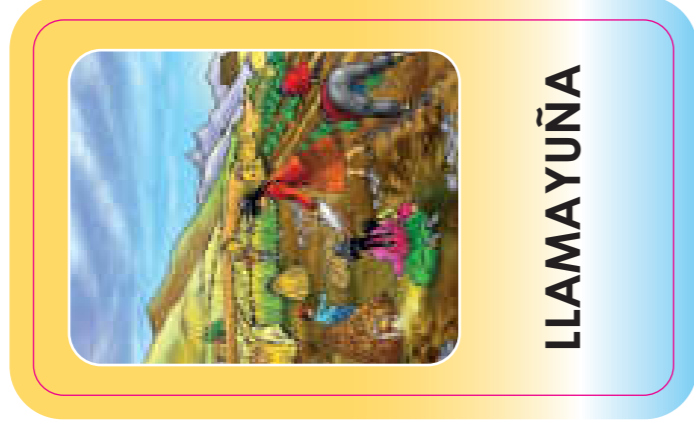

LLAMAYUÑA

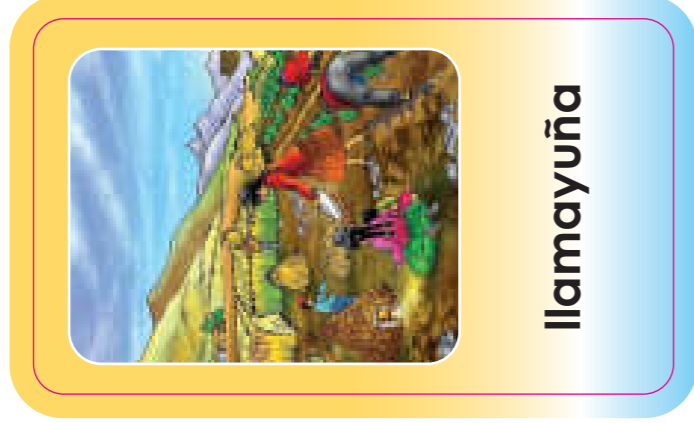

llamayuña

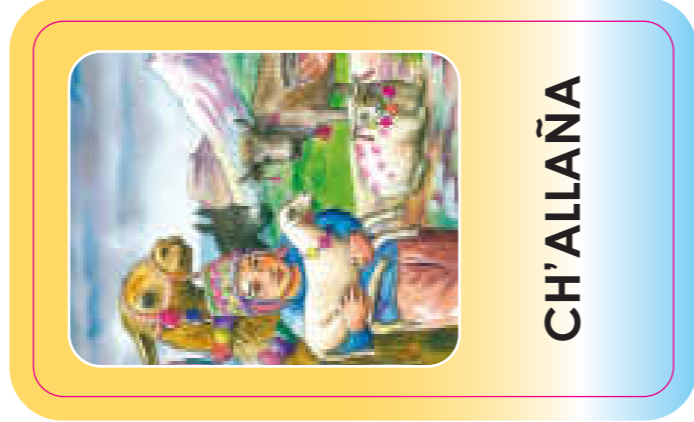

CH'ALLAÑA



ch'allaña

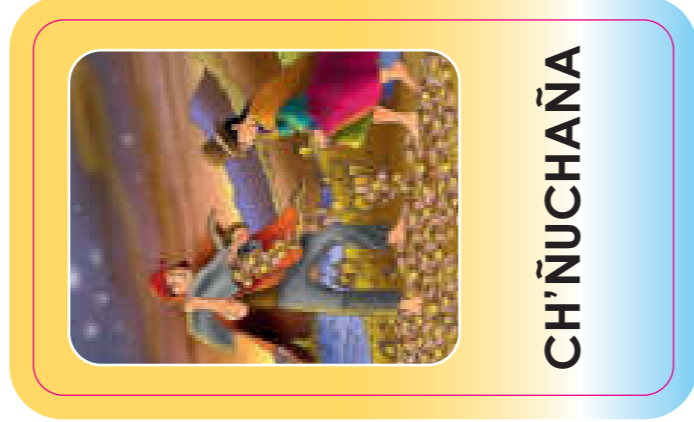

CH'ÑUCHAÑA

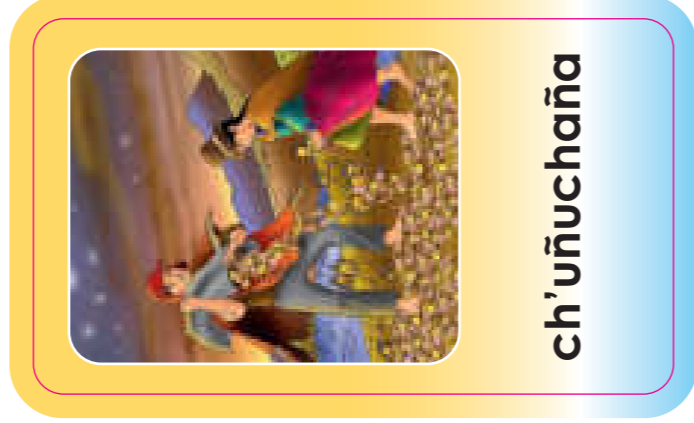

ch'uñuchaña

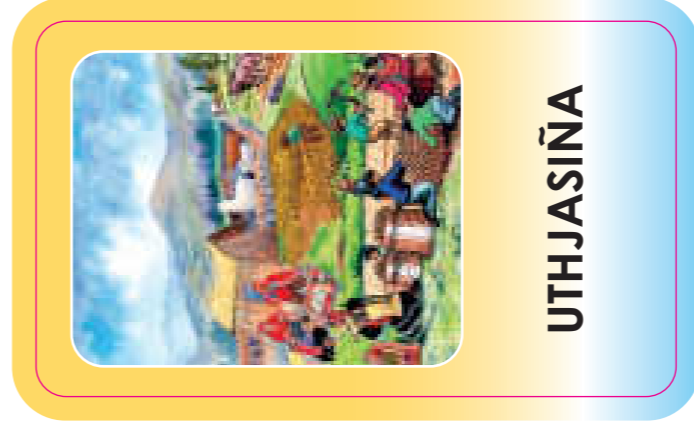

UTHJASIÑA

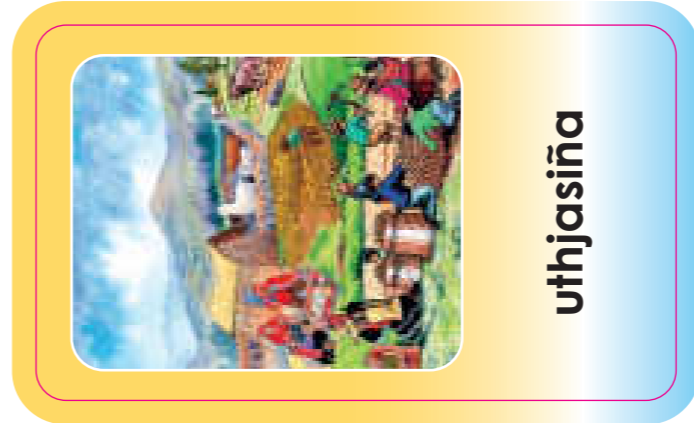

uthjasiña



YAPUCHAÑA



yapuchaña

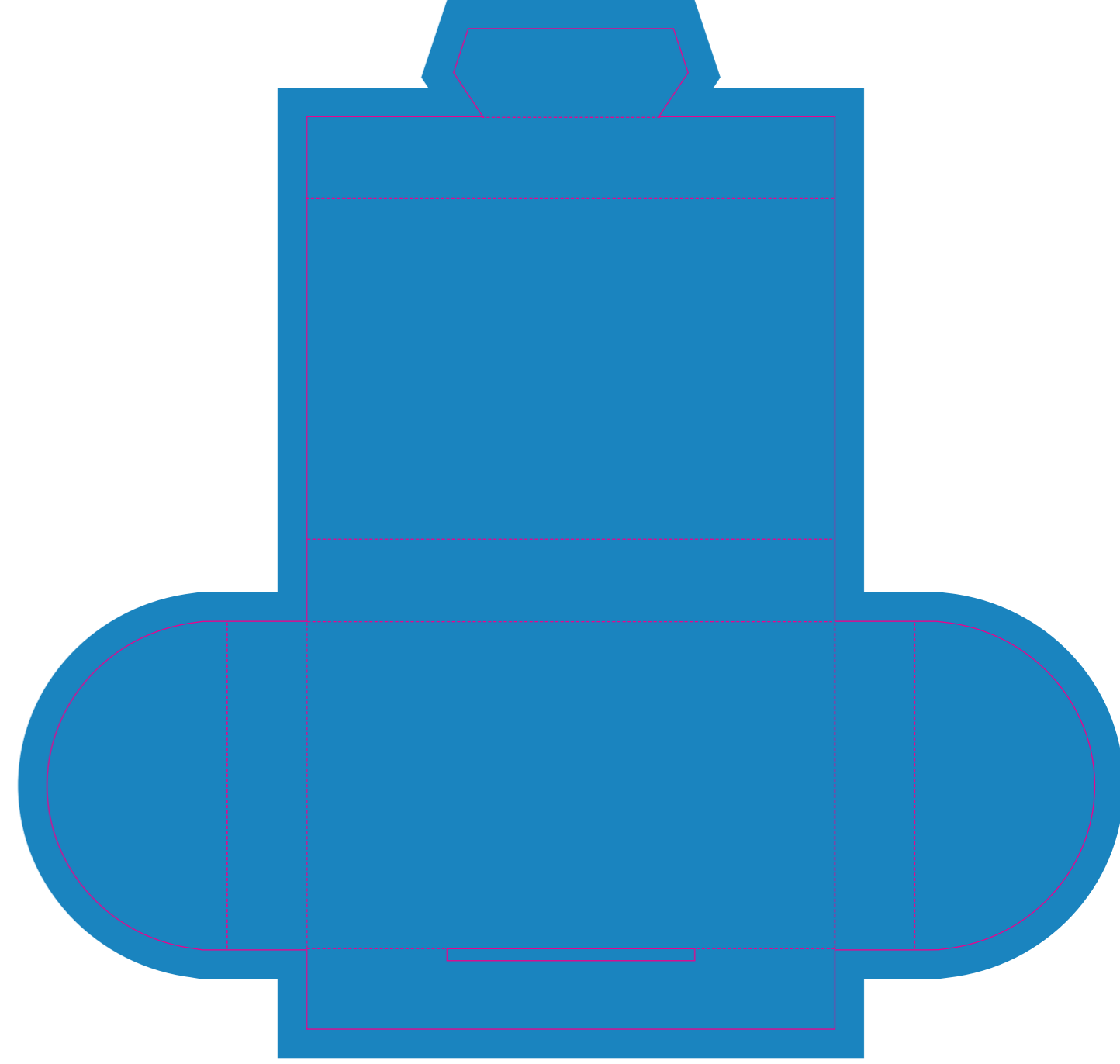

a	i	u	cha	chi	chu
chha	chhi	chhu	Ch'a	Ch'i	Ch'u
ja	ji	ju	ka	ki	ku
kha	khi	khu	k'a	k'i	k'u
la	li	lu	lla	lli	llu
ma	mi	mu	na	ni	nu
ña	ñi	ñu	pa	pi	pu

CHU	CHI	CHA	U	I	A
CH'U	CH'I	CH'A	CHHU	CHHI	CHHA
KU	KI	KA	JU	JI	JA
K'U	K'I	K'A	KHU	KHI	KHA
LLU	LLI	LLA	LU	LI	LA
NU	NI	NA	MU	MI	MA
PU	PI	PA	ÑU	ÑI	ÑA

pha	phi	phu	p'a	p'i	p'u
qa	qi	qu	qha	qhi	qhu
q'a	q'i	q'u	ra	ri	ru
sa	si	su	ta	ti	tu
tha	thi	thu	t'a	t'i	t'u
wa	wi	wu	xa	xi	xu
ya	yi	yu	a	i	u

P'U	P'I	P'A	PHU	PHI	PHA
QHU	QHI	QHA	QU	QI	QA
RU	RI	RA	Q'U	Q'I	Q'A
TU	TI	TA	SU	SI	SA
T'U	T'I	T'A	THU	THI	THA
XU	XI	XA	WU	WI	WA
U	I	A	YU	YI	YA

